

GP042-0186,4

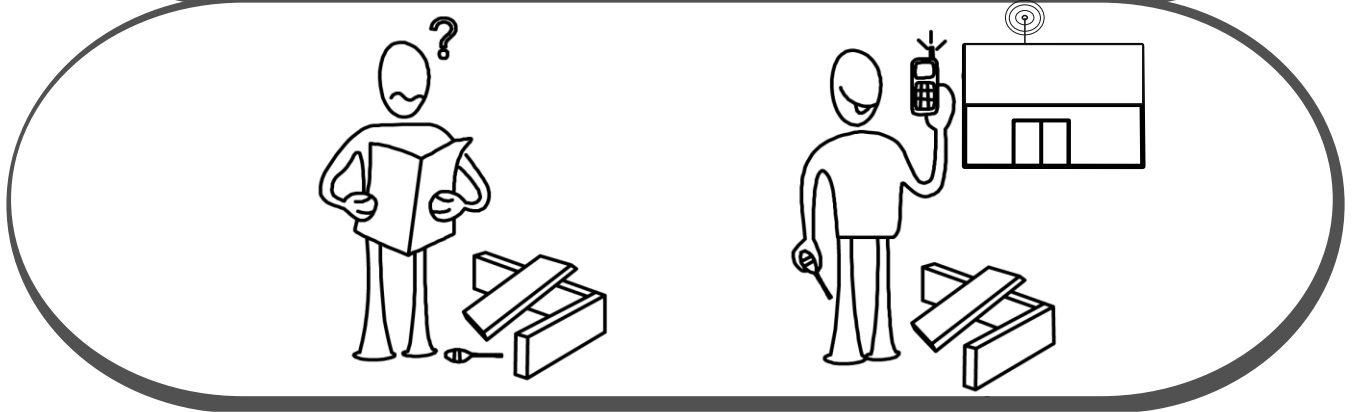

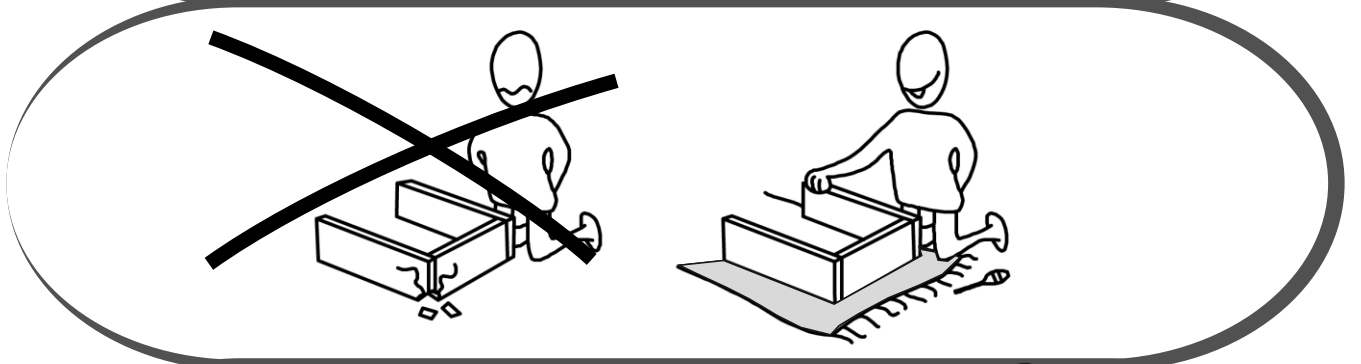

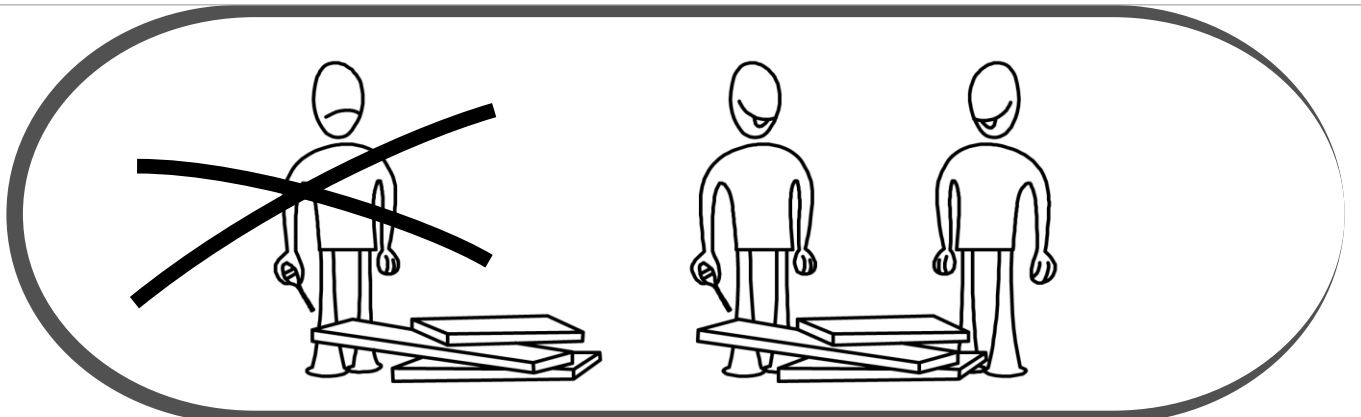

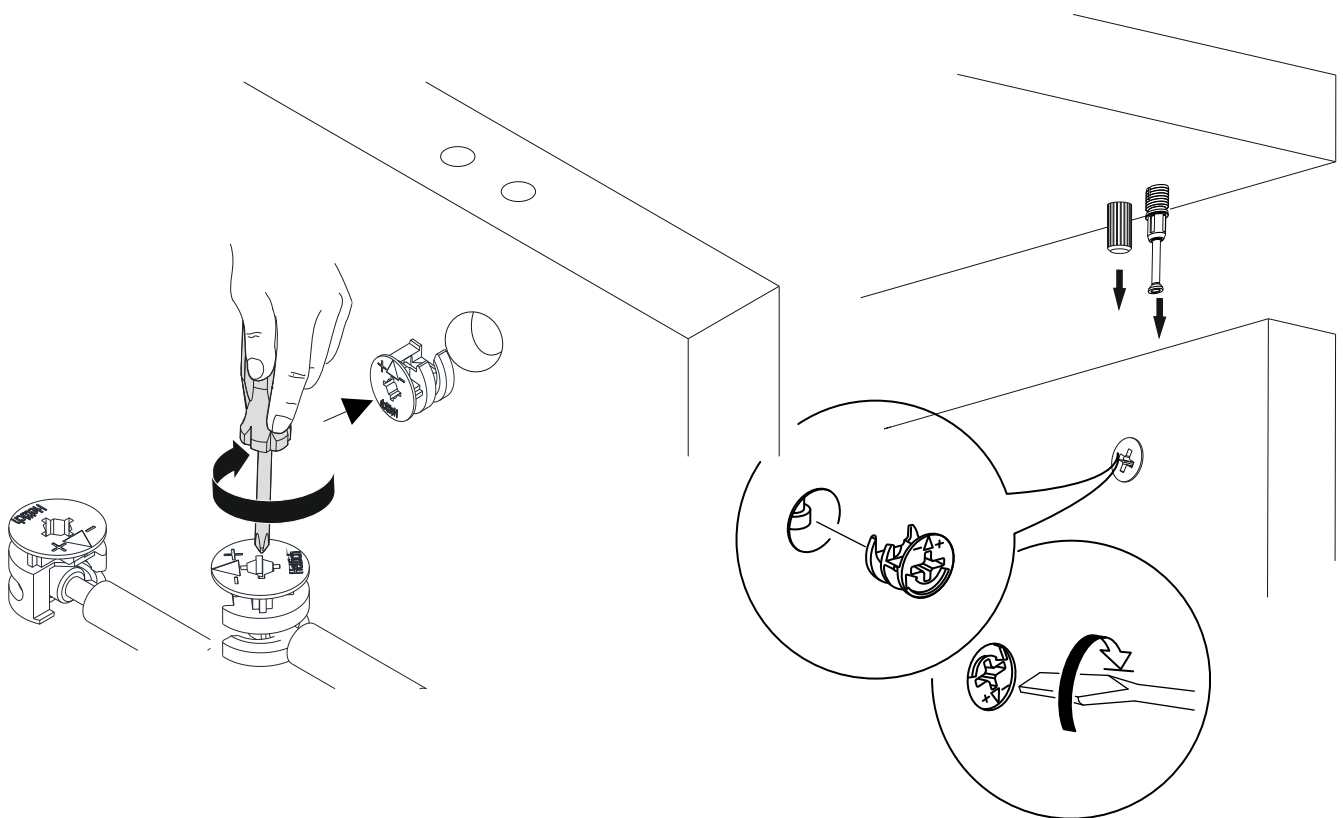
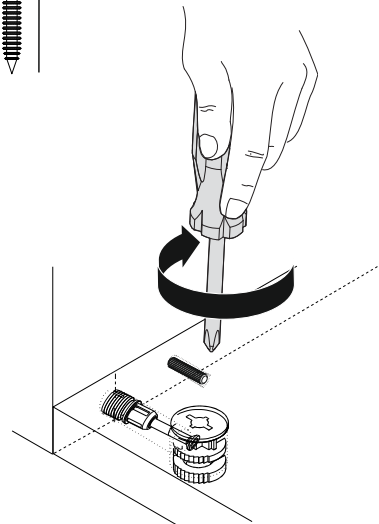
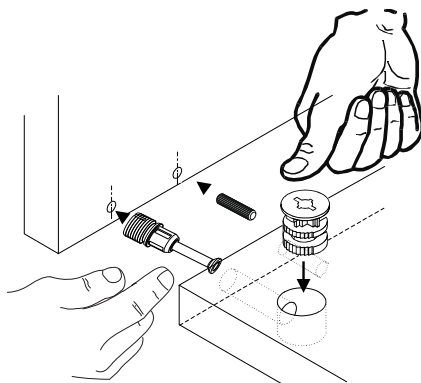
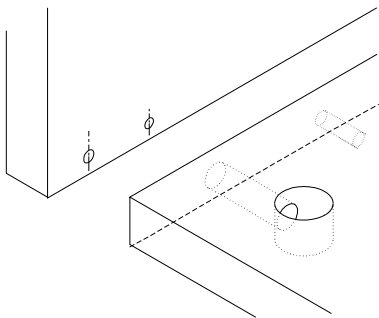
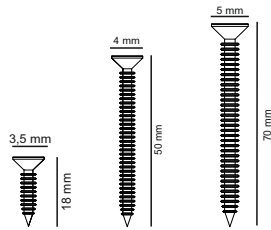
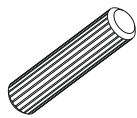
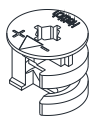
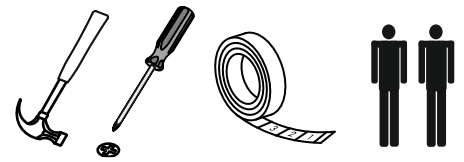





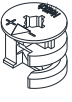
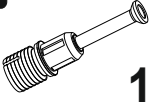
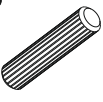
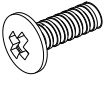
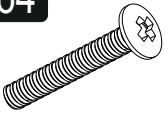
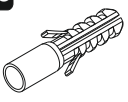

The necessary tools (not included)

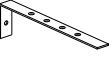
ACCESSORY LIST

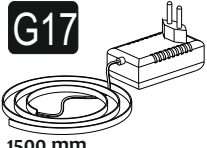
A01  15x	A02  15x	A03  8x	B20 M6x10 YHB  12x	B64 M6x30  2x
D69 Ø8 Lik Rkt  4x	D41 5x70 YHB  4x	A04  A 15x	D91  DKR-194 Hi82*15*15 SYH 2x	D92  DKR-195 H200*20*2 SYH 2x
A16  A 2x	G17  1500 mm 1x			

GENERAL VIEW

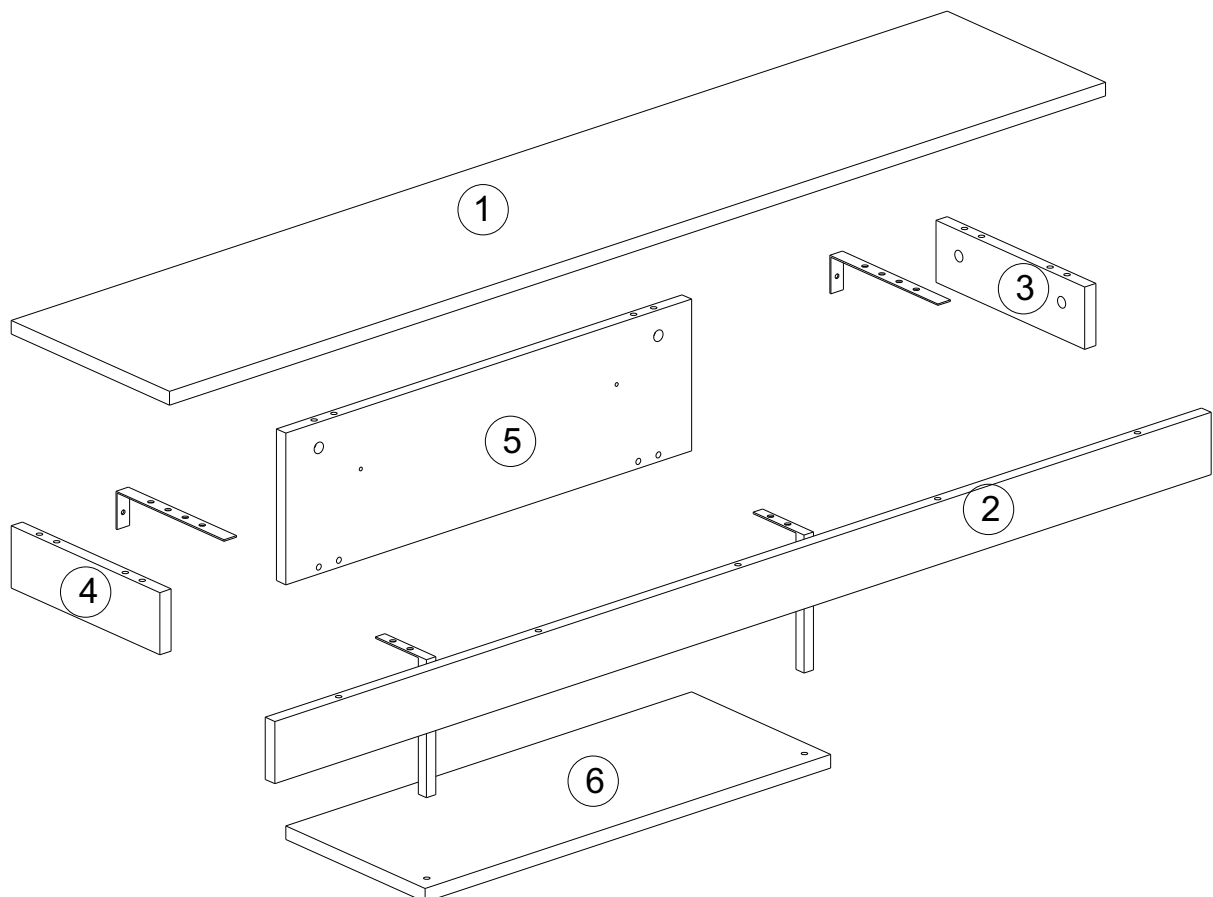

1

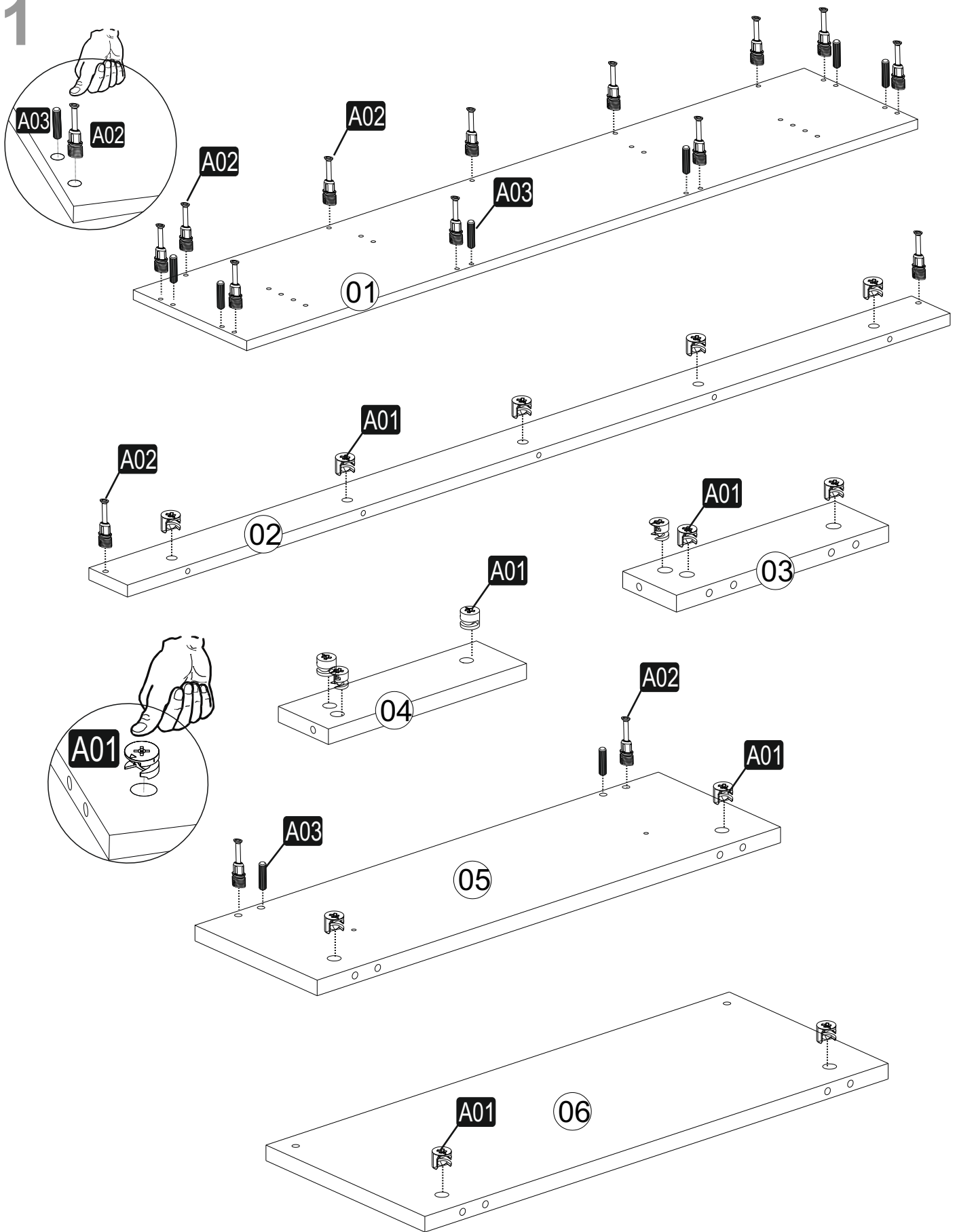

2

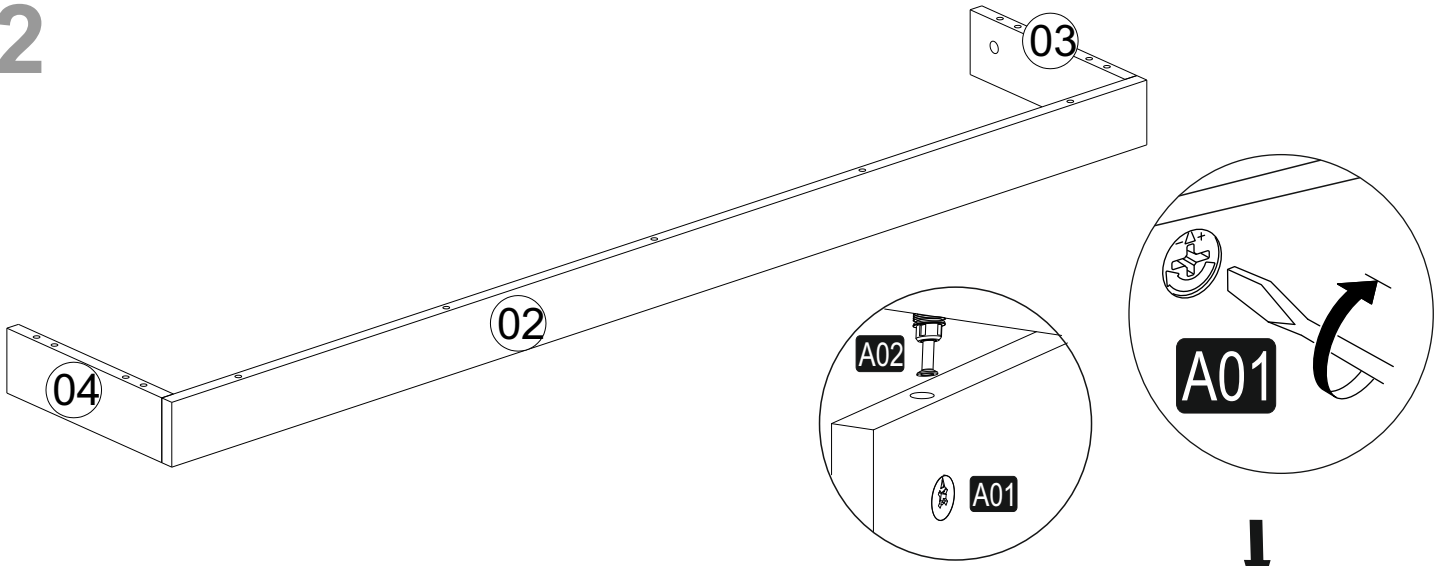

3

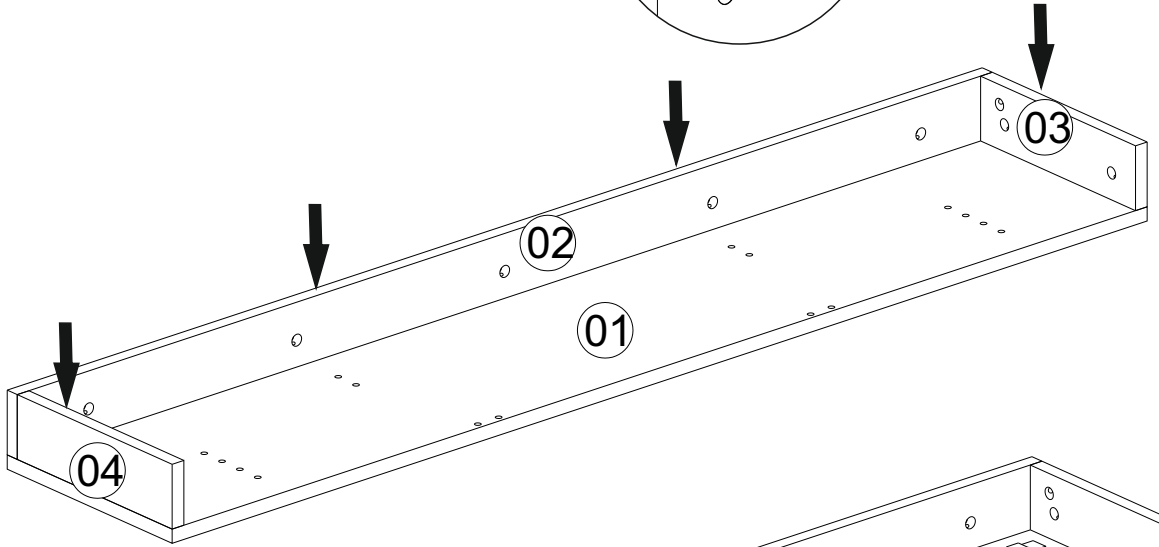

4

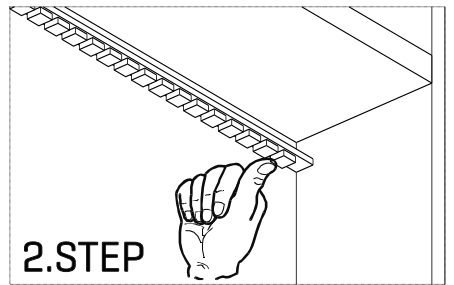
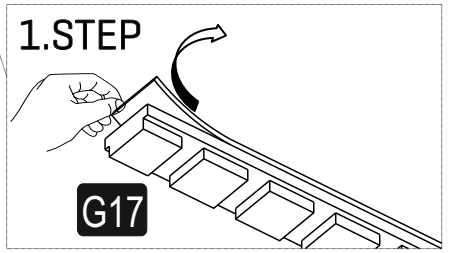
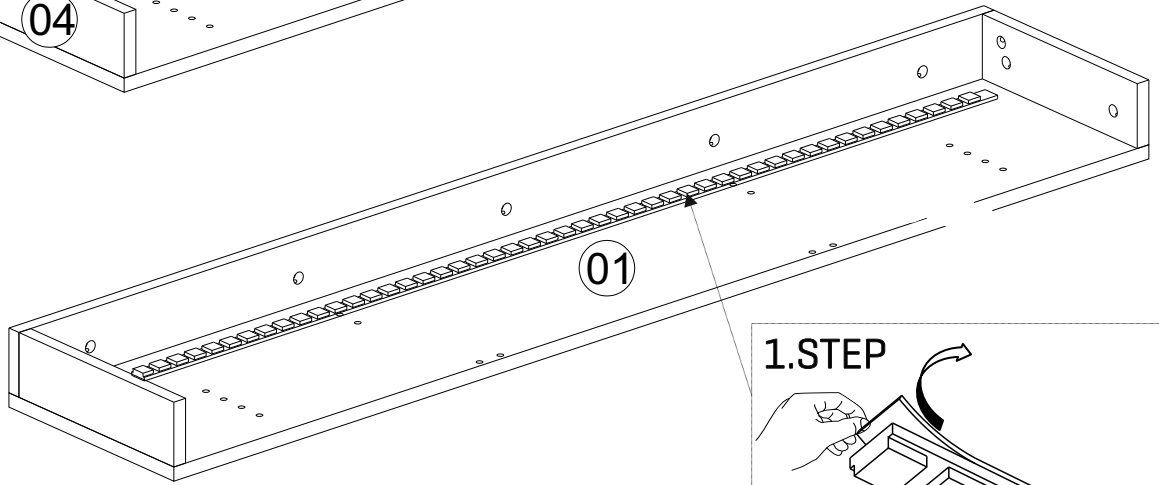

5

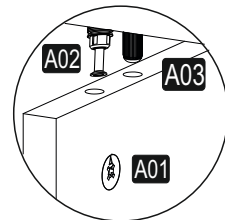
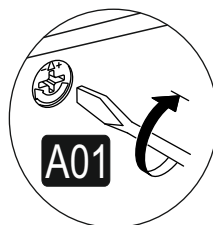
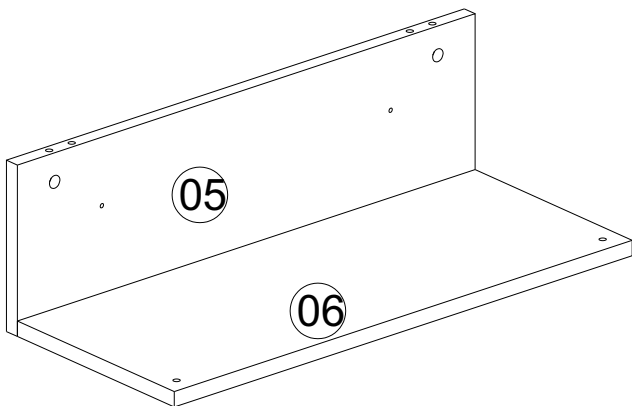

6

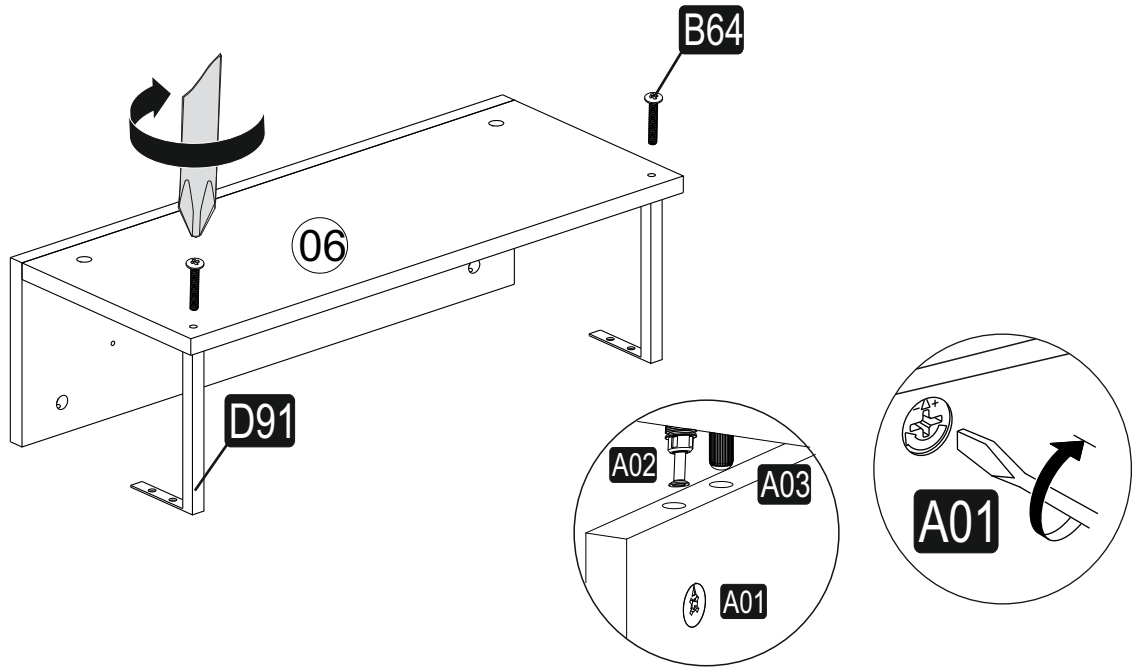

7

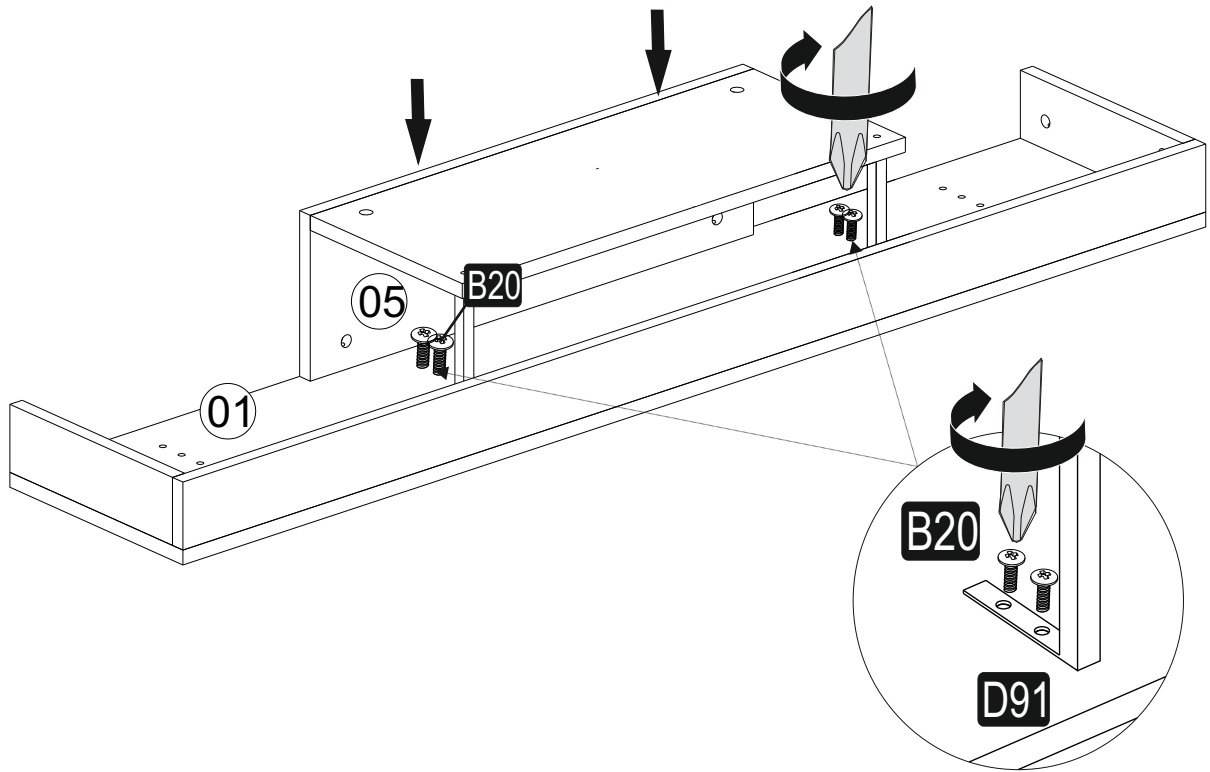

8

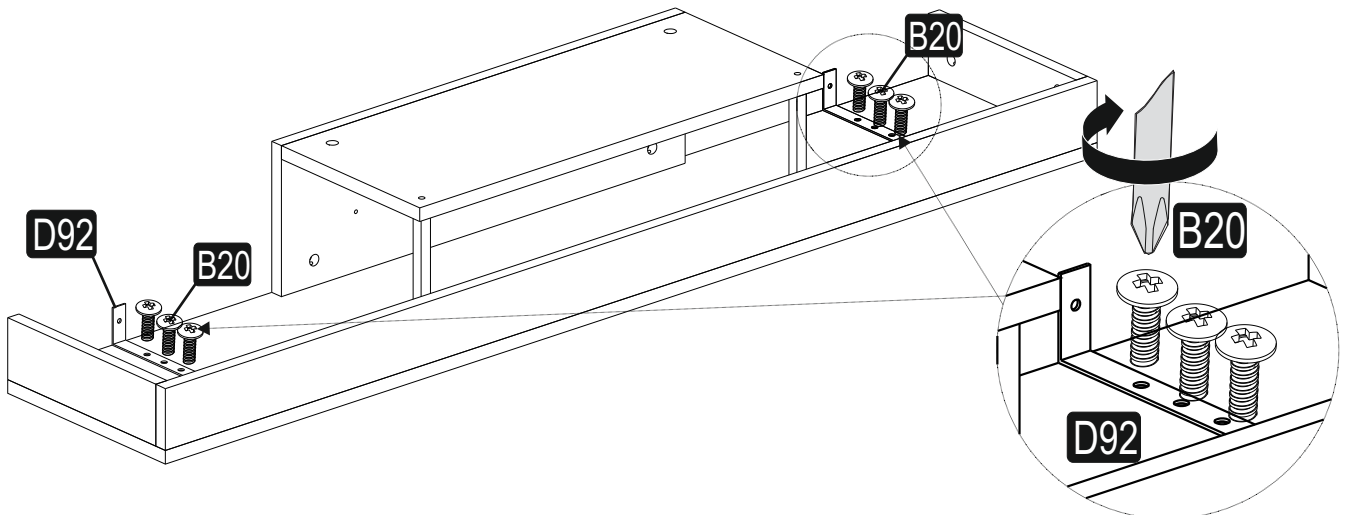

9

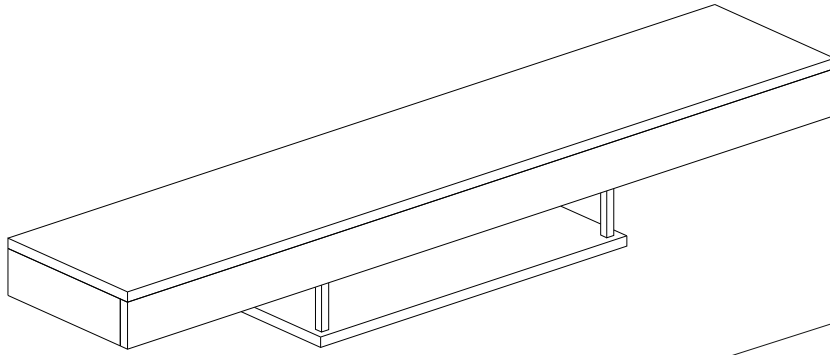

PART-1

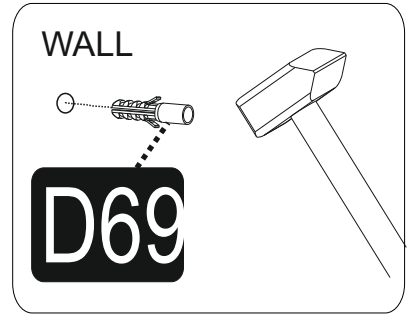
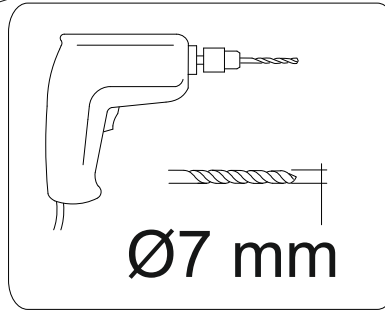

PART-2

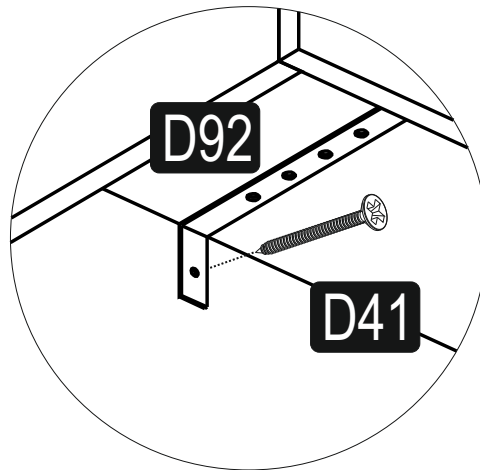

PART-3

