

GP042-0099,1

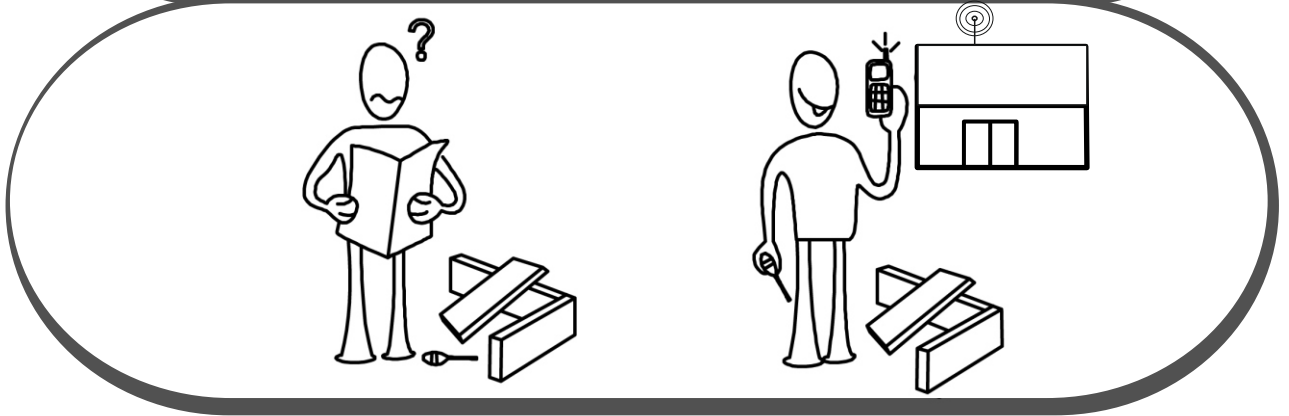

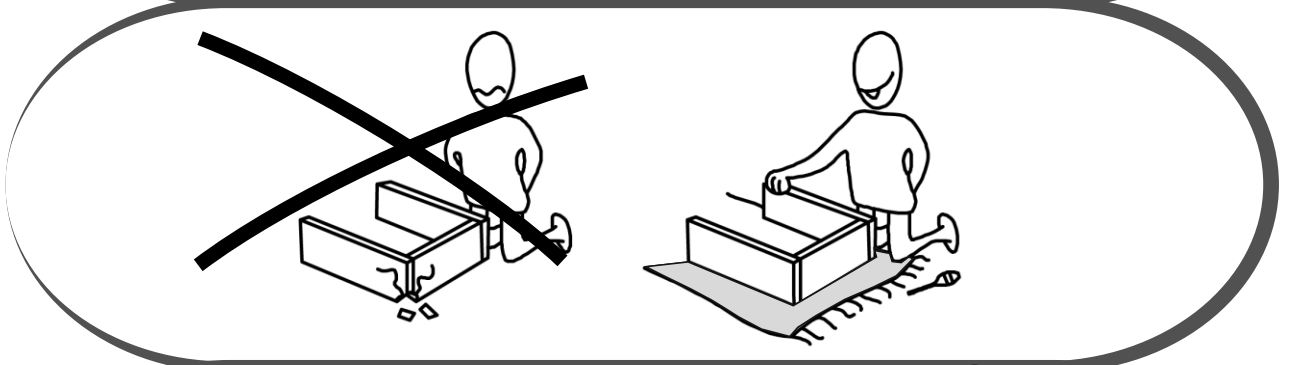

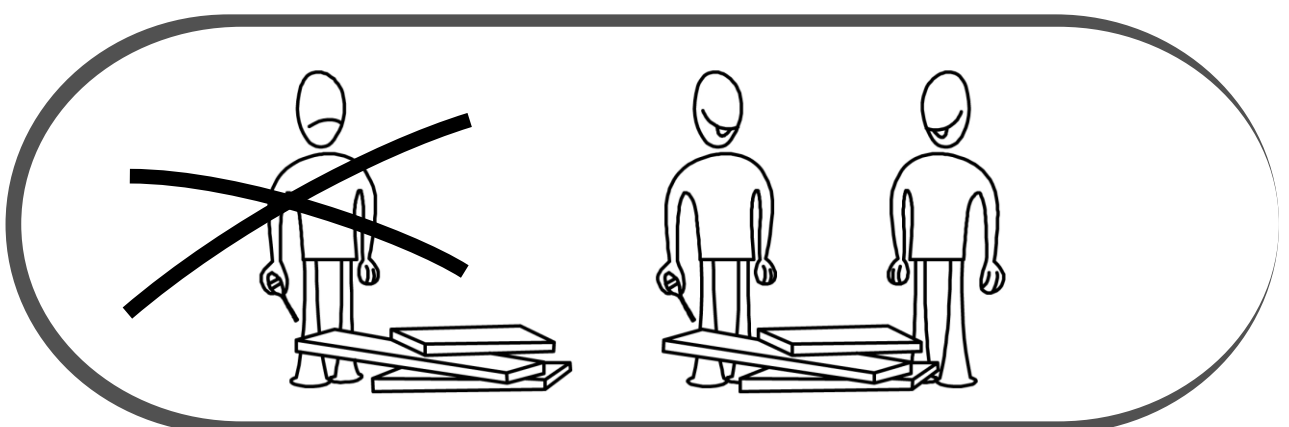

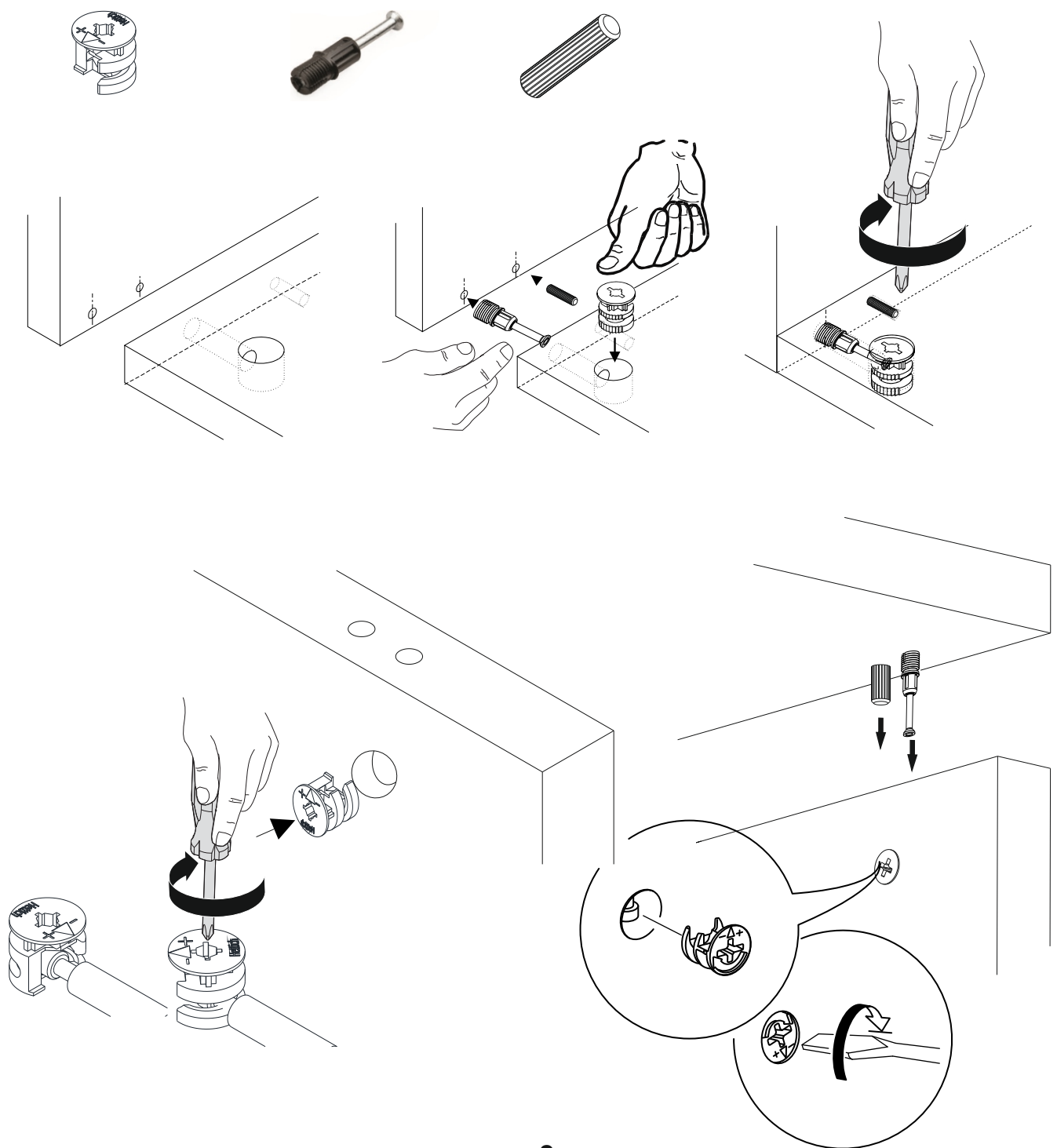
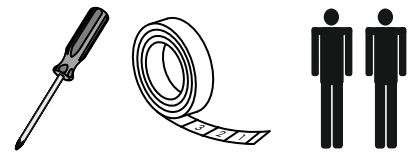





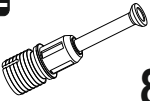

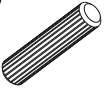
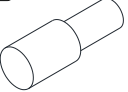

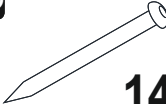

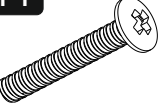
The necessary tools (not included)

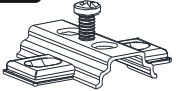
ACCESSORY LIST

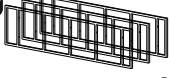
A02  8x	A01  8x	A03  8x	A23  4x	A09 4x50  5x
A10 3,5x18  16x	A28  14x	A38 3,5x35  30x	A14 M4x22  8x	A91  2x
A04  A 8x	A13  4x	A12  4x	B55  1x	

GENERAL VIEW

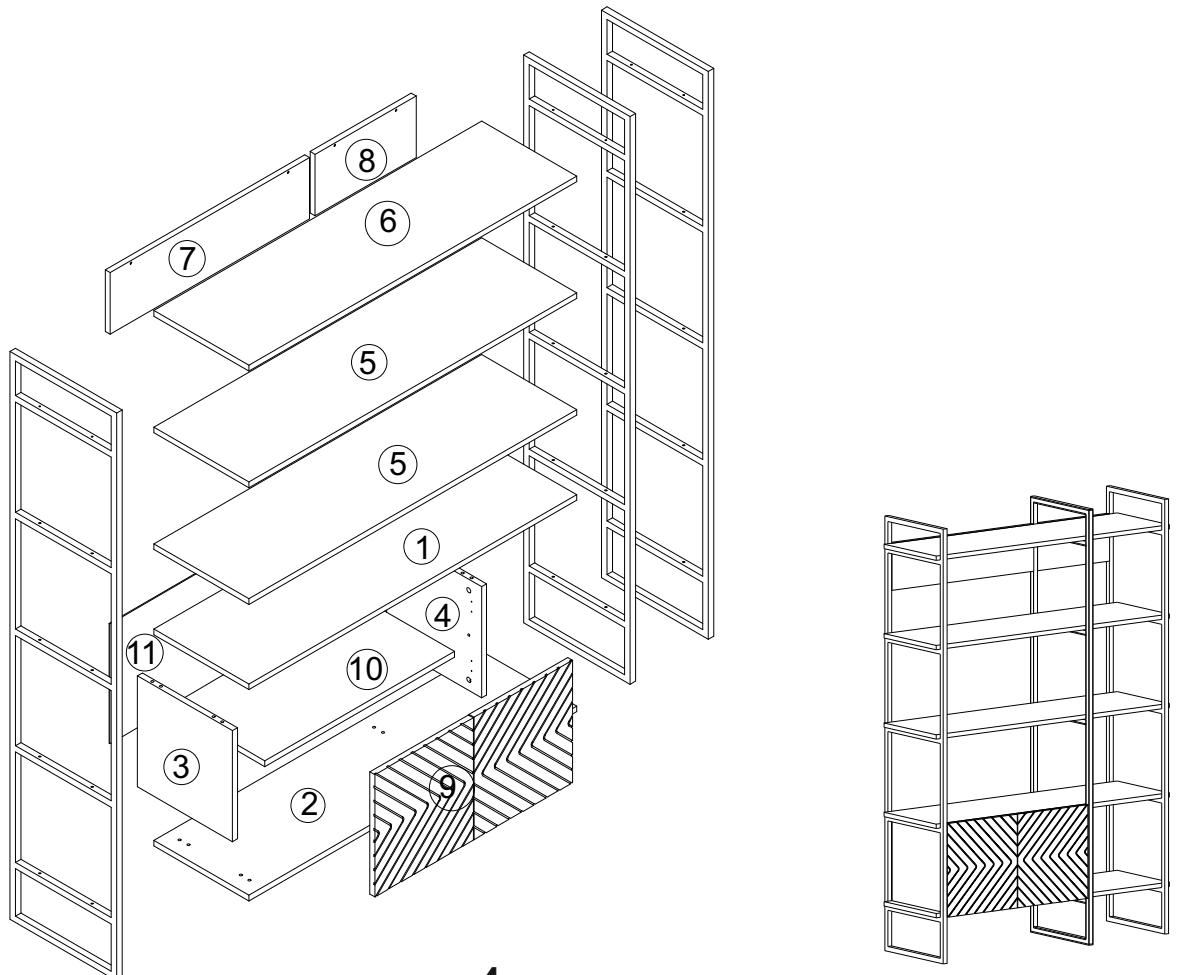

1

