

**GP041-0030,4**

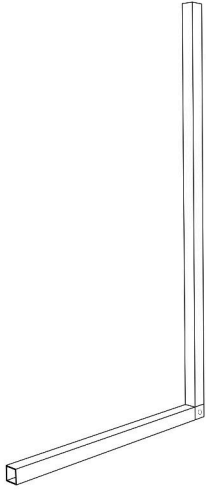

**A**



**x2**

**B**

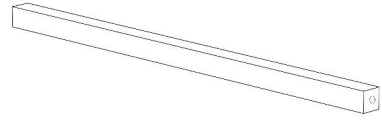

**x1**

**C**

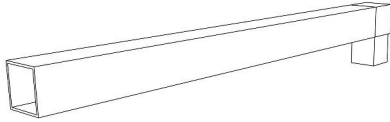

**x2**

**D**



**x2**

**E**

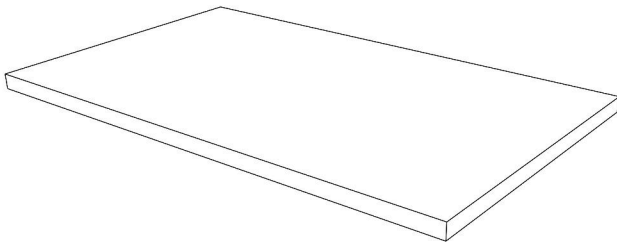

**x1**

a

x6

b

x4

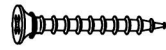

M5x50

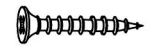

M4x35

c

x4

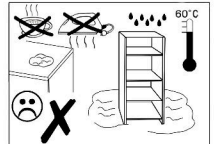
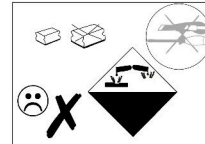
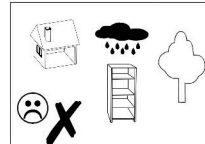
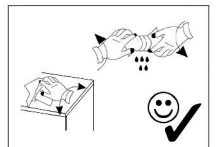
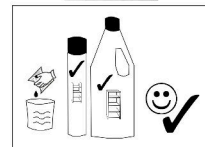
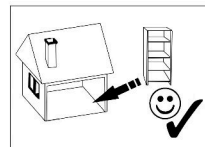
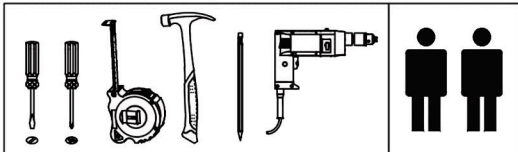
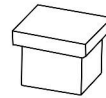

01

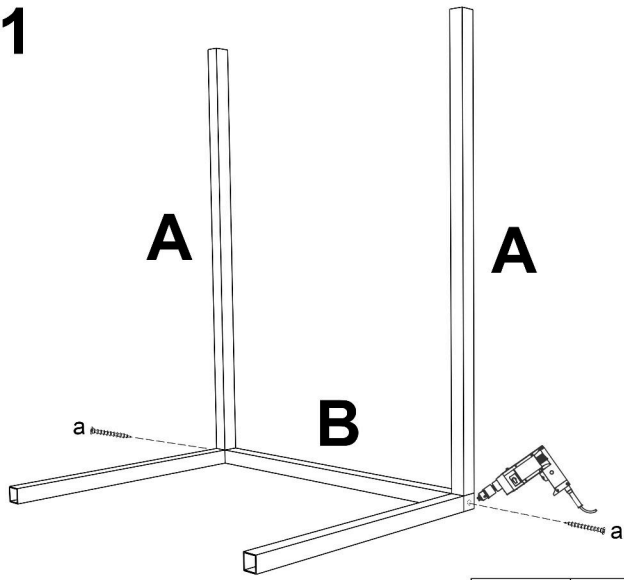

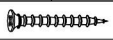
a	x2
	
M5x50	

02

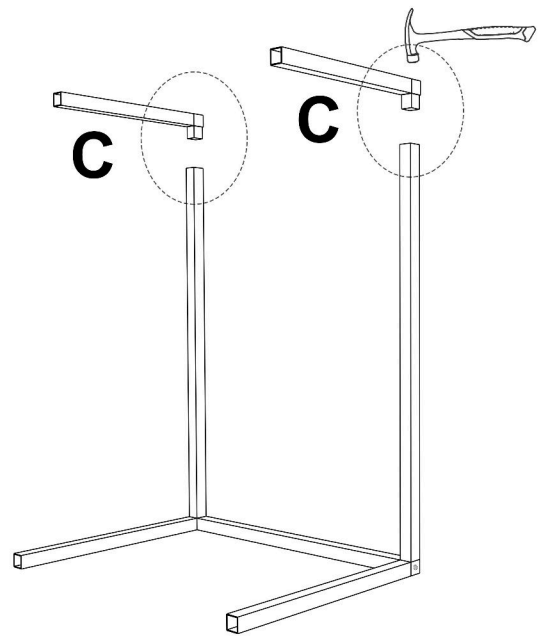

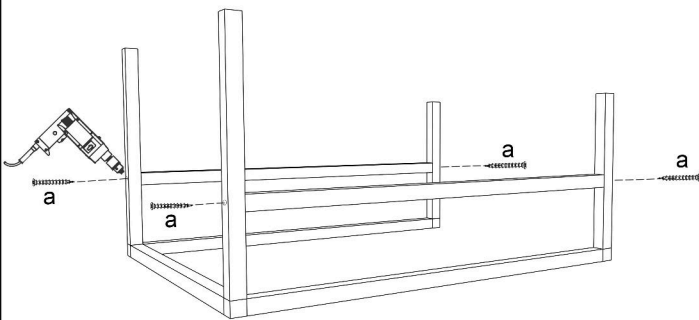

03

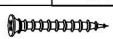

a	x4
	
M5x50	

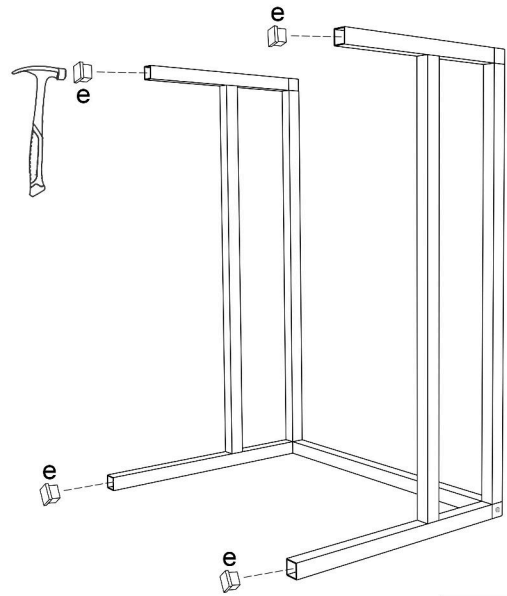
04



e	x4
	

05

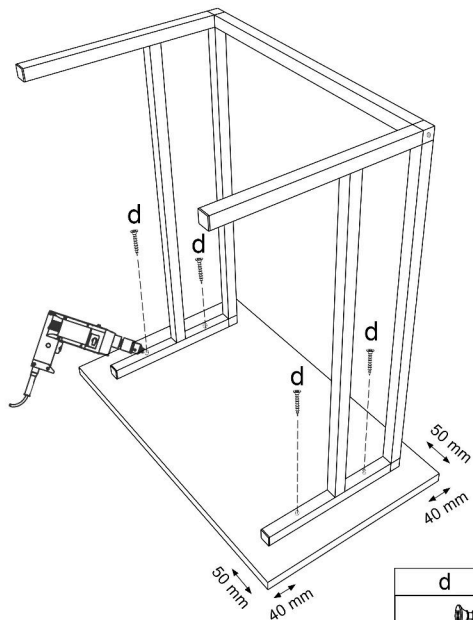

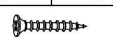
d	x4
	
M4x35	