

GP041-0004,3

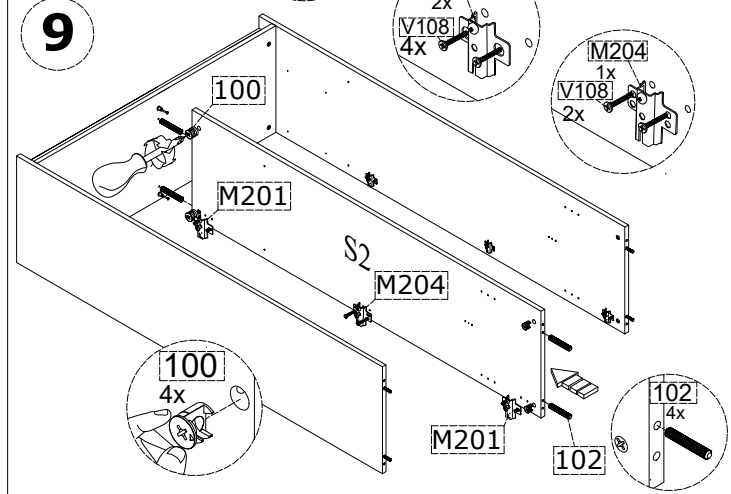

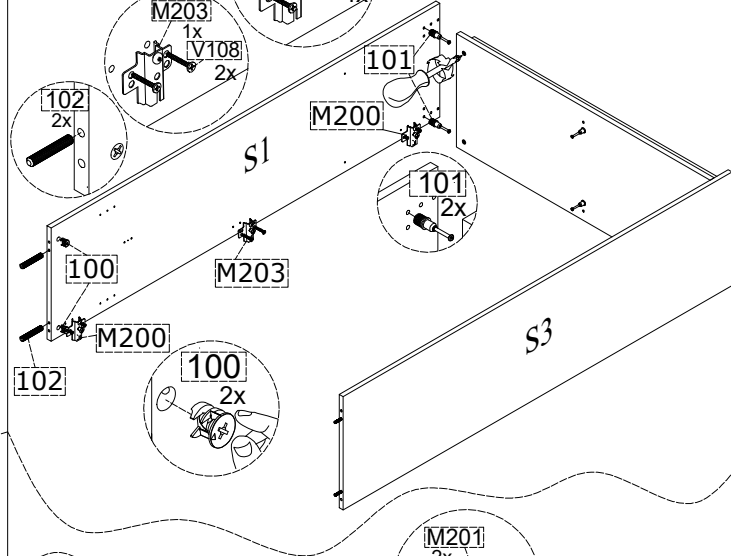

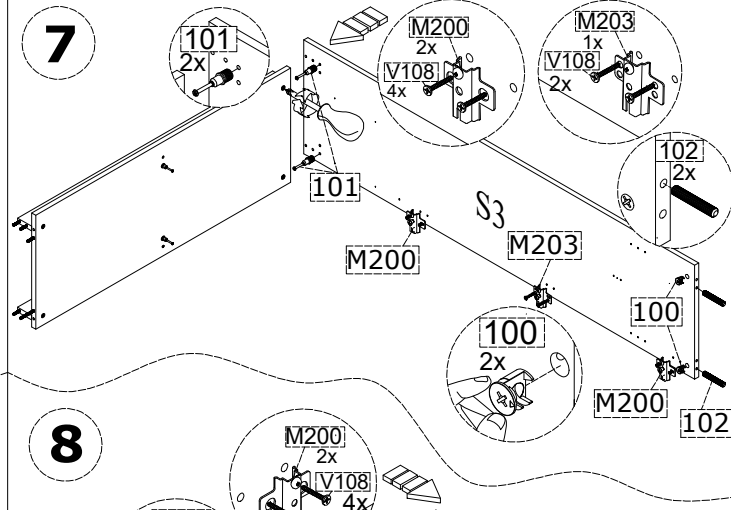
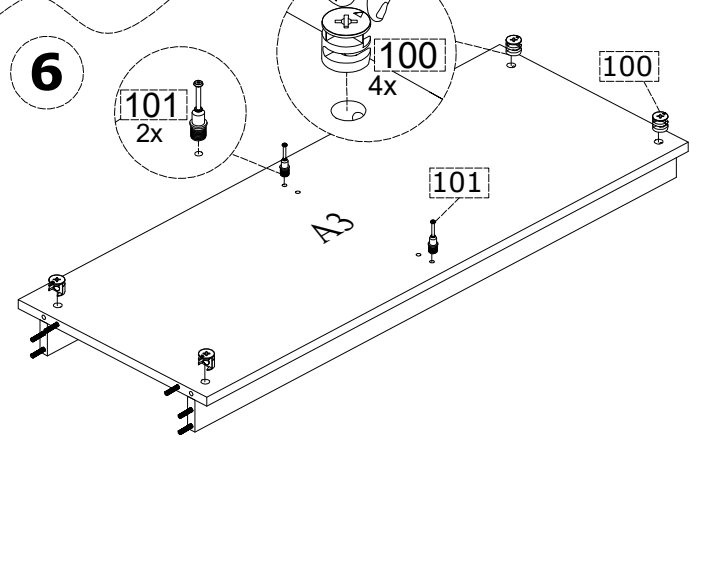
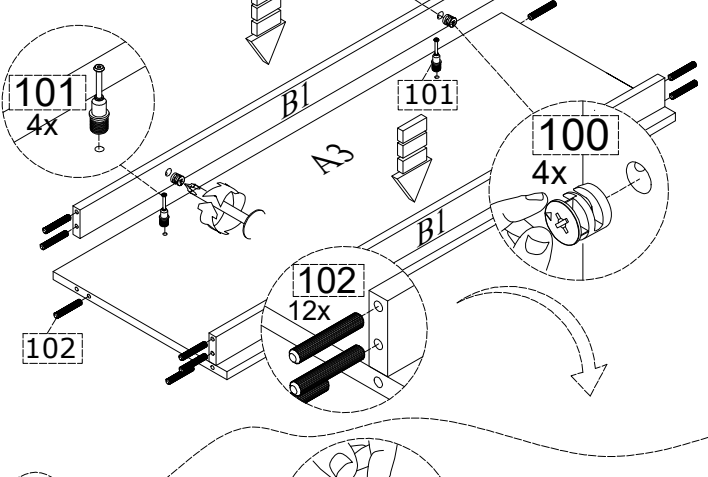
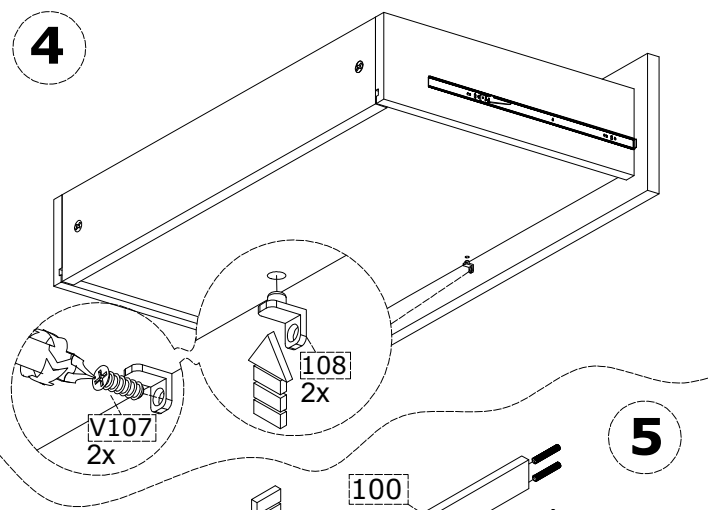
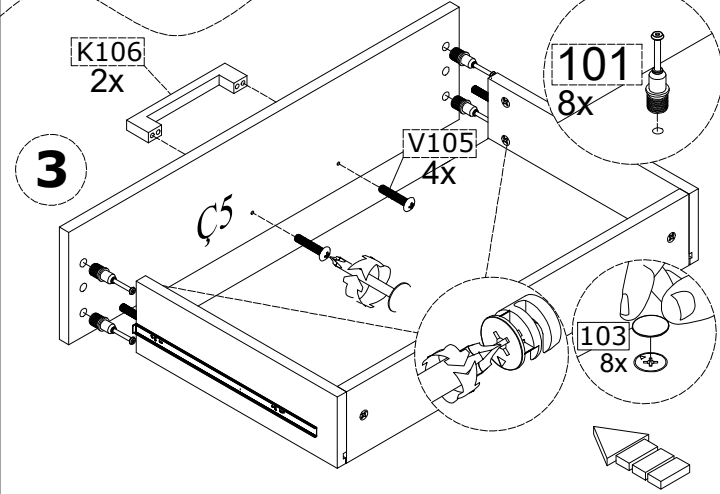
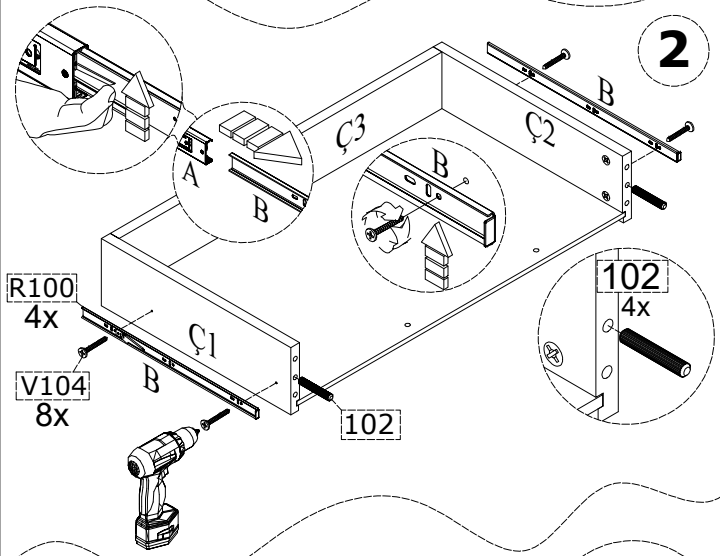
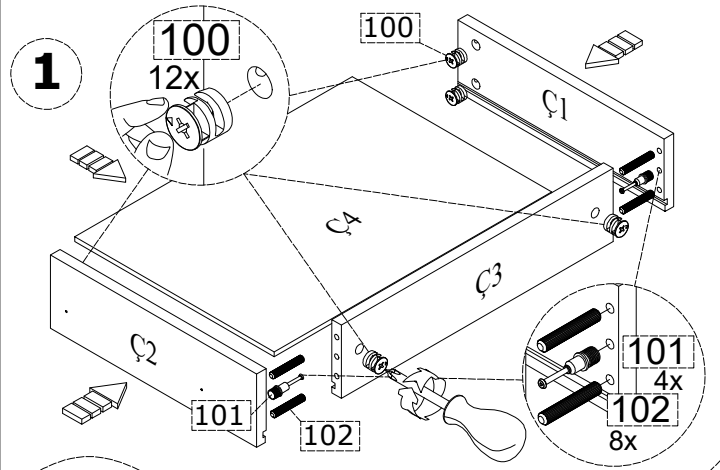
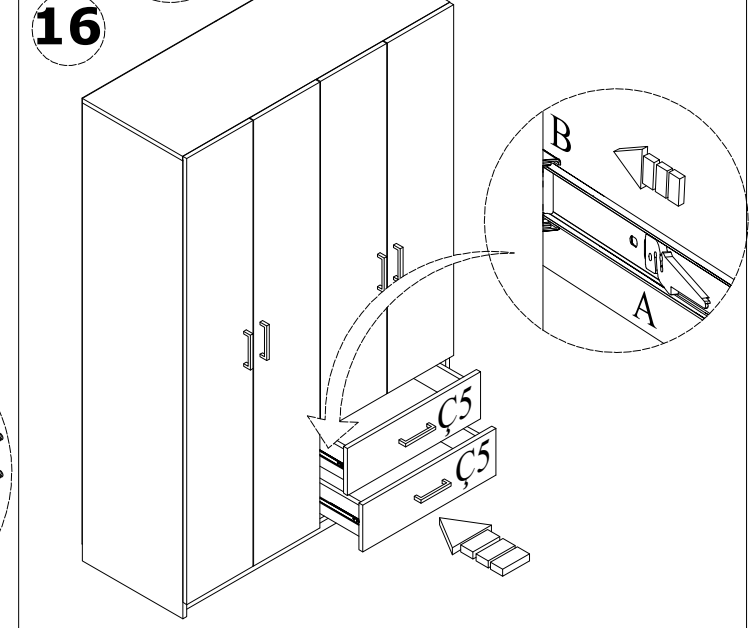
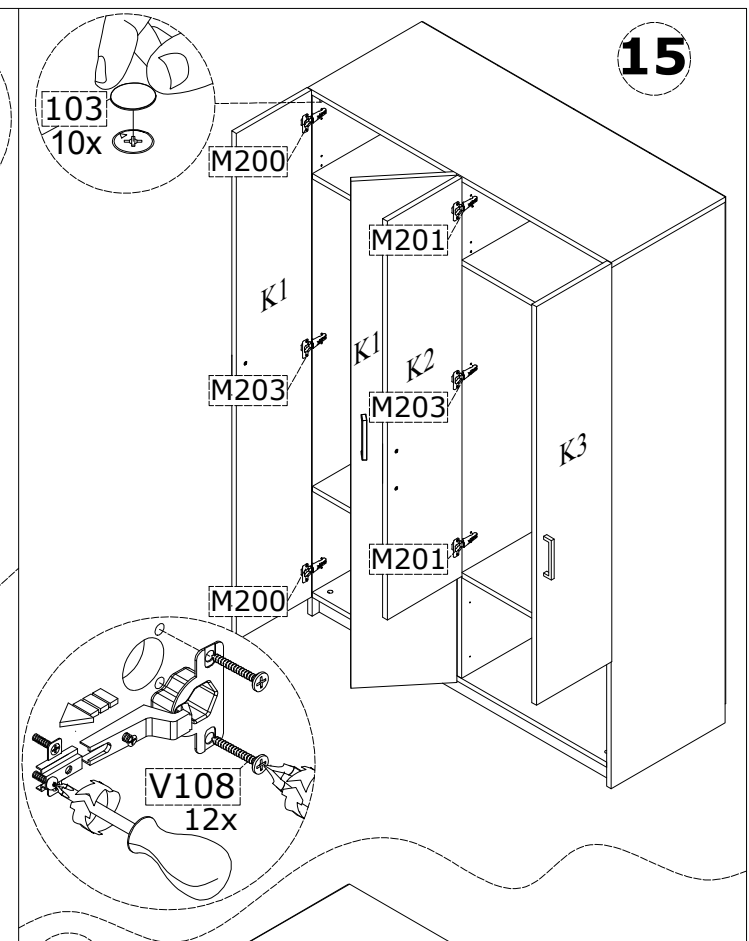
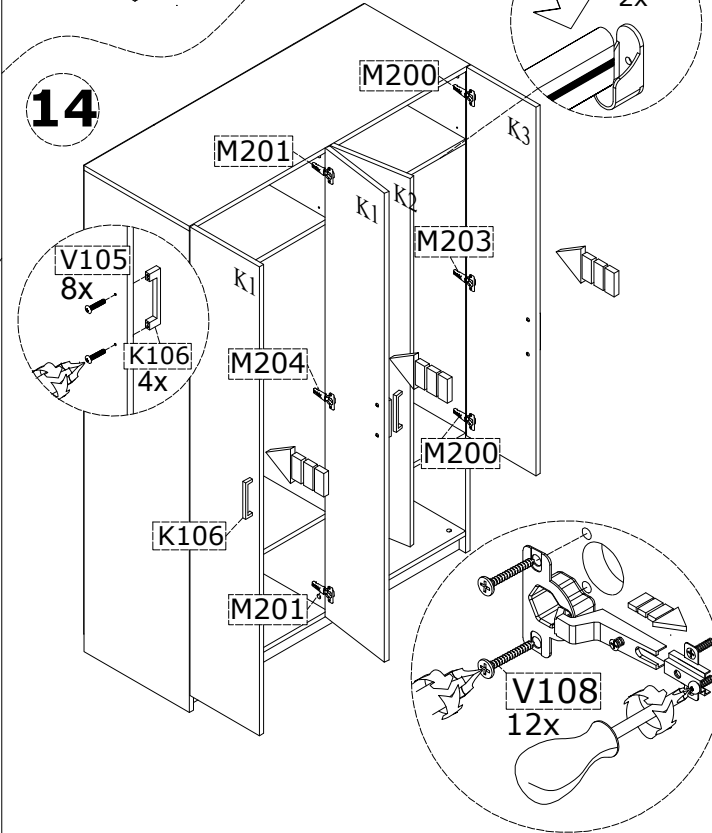
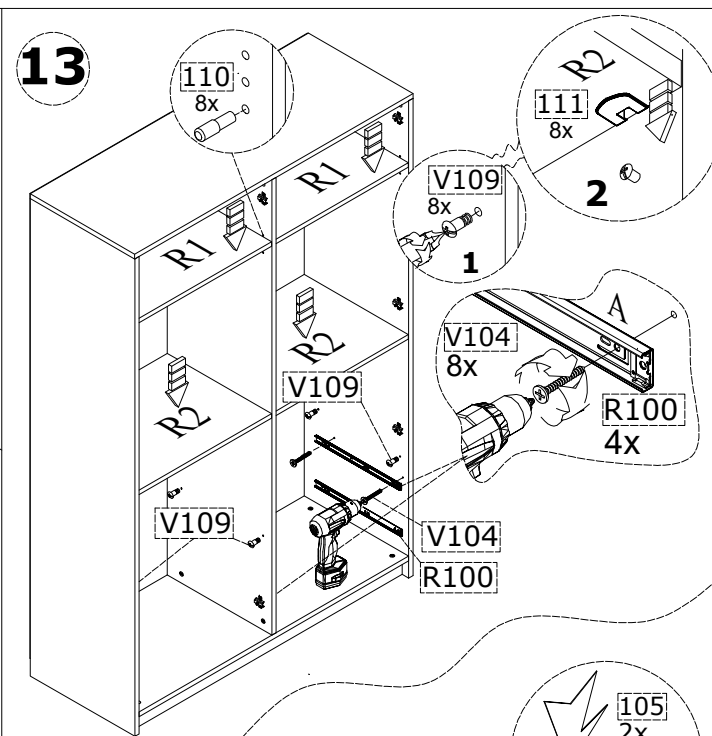
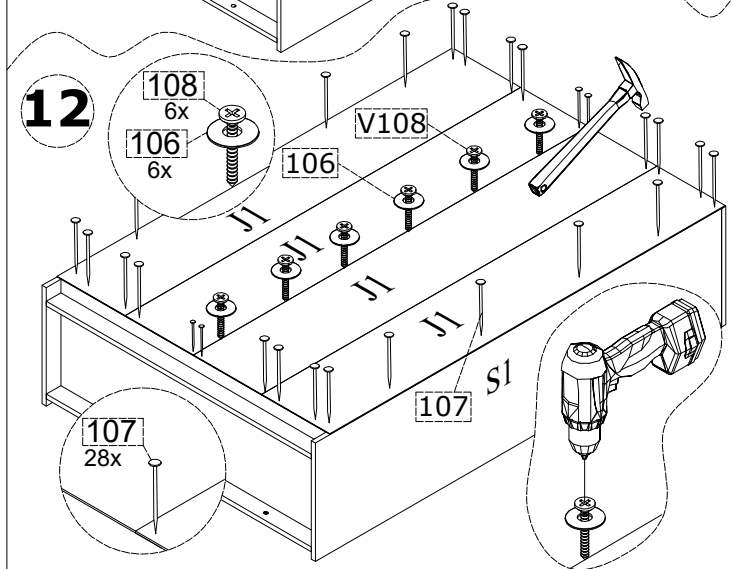
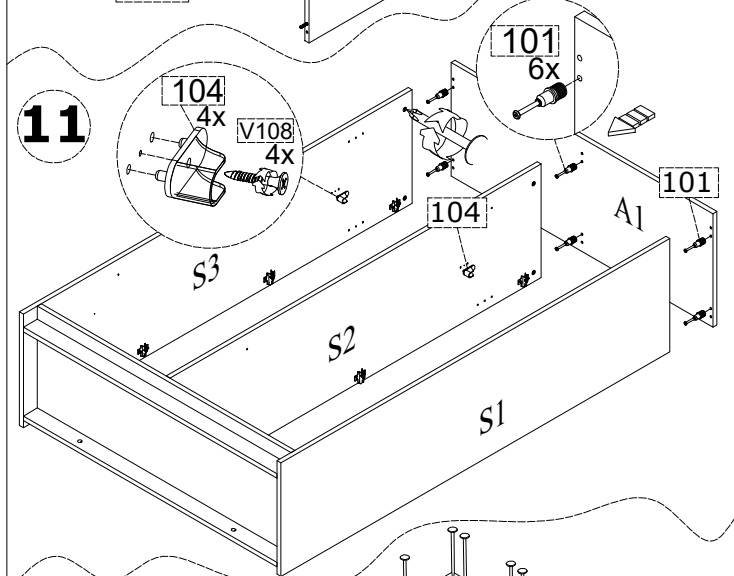
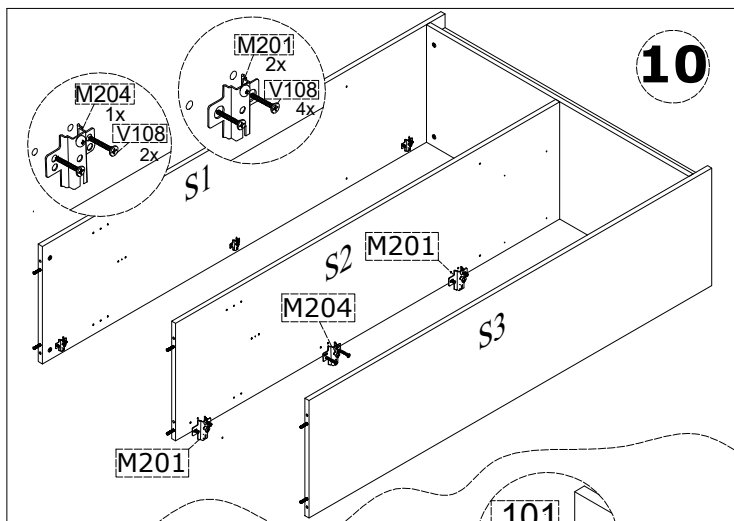

- PKG1
- A**
- R2 2X
- R1 2X
- C2 2X
- C1 2X
- C4 2X

- PKG2
- A1 1X
- A3 1X
- B1 2X
- 105 2X

- PKG3
- S1 1X
- S2 1X
- S3 1X

- PKG4
- K1 2X
- J1 4X

- PKG5
- K2 1X
- K3 1X
- C5 2X
- C3 2X

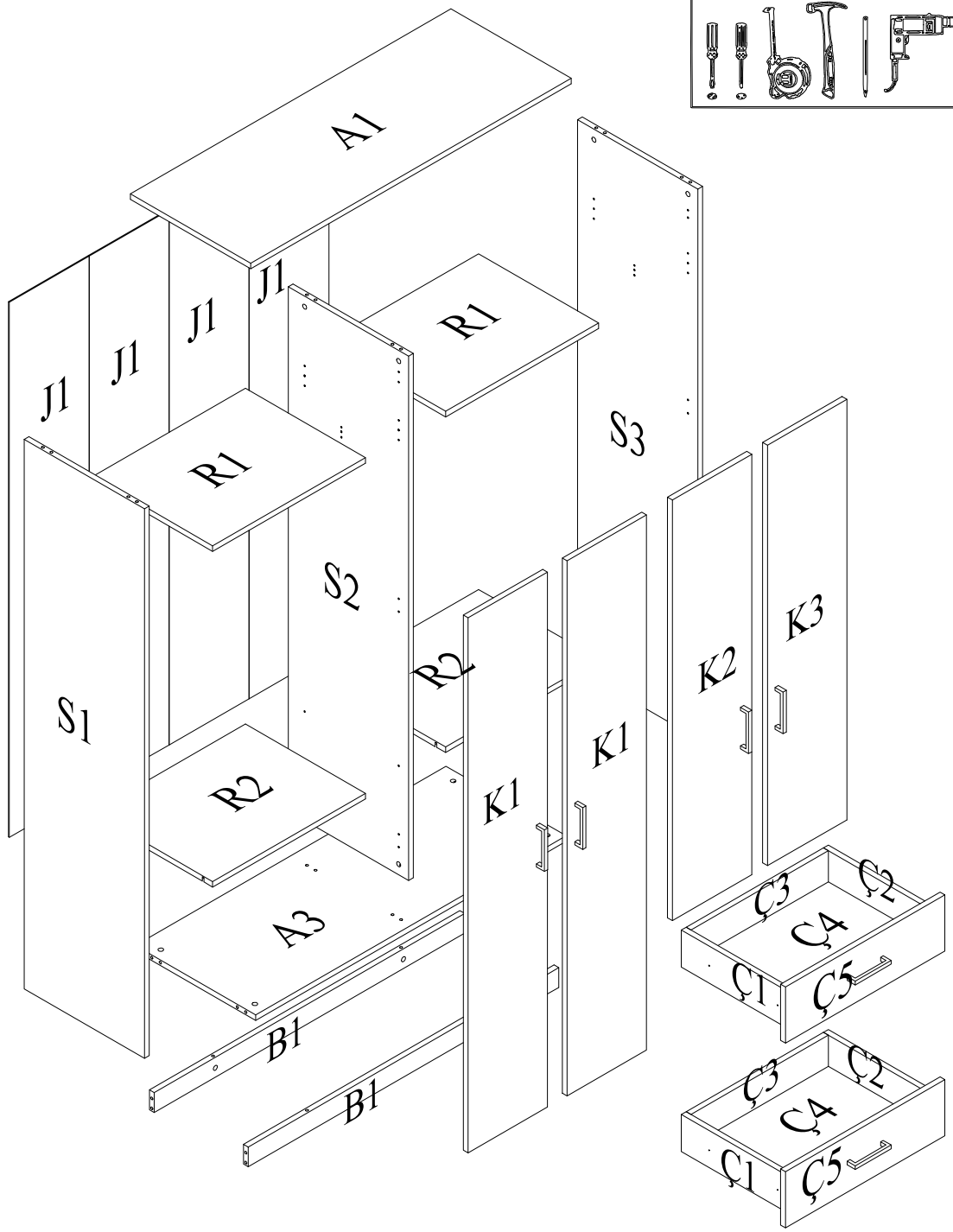
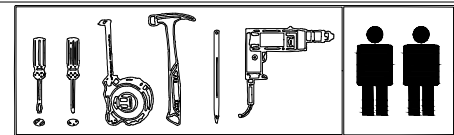

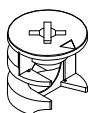

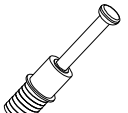
ACCESSORY NO:100
MINIFIX BODY

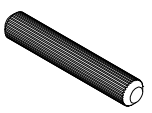
28 PCS

ACCESSORY NO:101
MINIFIX SPINDLE

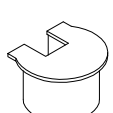
28 PCS

ACCESSORY NO:102
Ø8 x 34 PLASTIC DOWEL

32 PCS

ACCESSORY NO:103
MINIFIX TAP

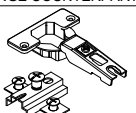
18 PCS

ACCESSORY NO:111
RAFFIX BODY

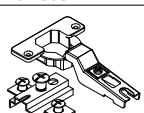
08 PCS

ACCESSORY NO:V109
RAFFIX SHAFT
Ø6x7,5 MM

08 PCS

ACCESSORY NO:M200
HINGE
HINGE COUNTERPARTS

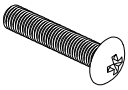
04 PCS

ACCESSORY NO:M201
HALF OVERLAY HINGE
HINGE COUNTERPARTS

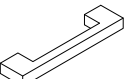
04 PCS

ACCESSORY NO:V104
CHIPBOARD SCREW
3,5x18 MM

16 PCS

ACCESSORY NO:V105
HANDLE SCREW
M4x21 MM

12 PCS

ACCESSORY NO:K106
CORNER HANDLE,
BLACK

06 PCS

ACCESSORY NO:R100
DRAWER RAIL
24x350 MM

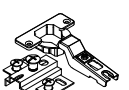
04 PCS

ACCESSORY NO:M203
STOPPER HINGE
HINGE COUNTERPARTS

02 PCS

ACCESSORY NO:M204
STOPPER HALF
OVERLAY HINGE
HINGE COUNTERPARTS

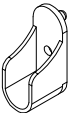
02 PCS

ACCESSORY NO:V108
CHIPBOARD SCREW
4x18 MM

59 PCS

ACCESSORY NO:104
HANGER FLANGE

04 PCS

ACCESSORY NO:107
NAIL

28 PCS

ACCESSORY NO:108
Ø5 SHELF PIN

02 PCS

ACCESSORY NO:V107
COUNTERSUNK SCREW
Ø6x7,5 MM

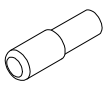
02 PCS

ACCESSORY NO:110
SHELF PIN
METAL BODY

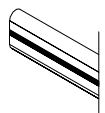
08 PCS

ACCESSORY NO:105
565 MM STRIPED
HANGER PIPE

02 PCS

ACCESSORY NO:106
SCREW WASHER

06 PCS

Empty box

Empty box