

GP037-0045,1

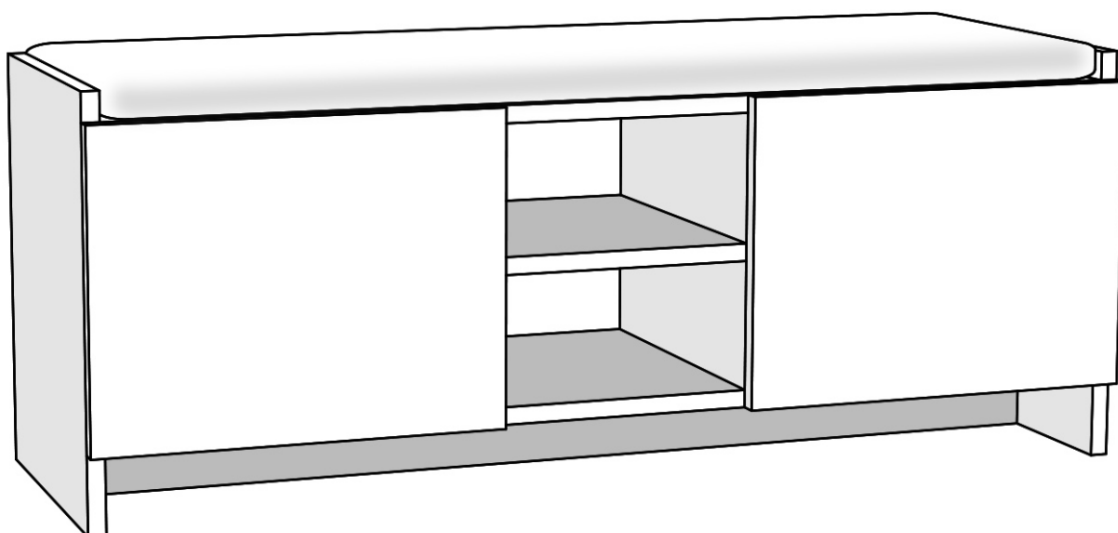

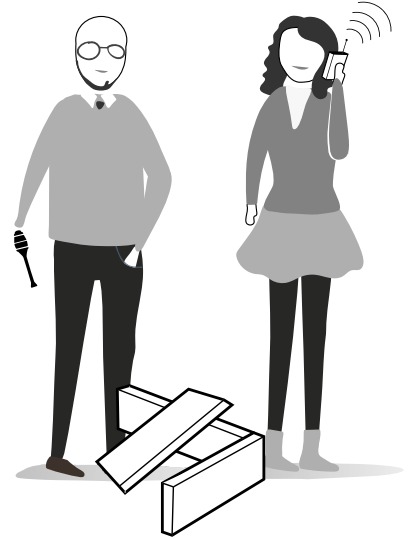
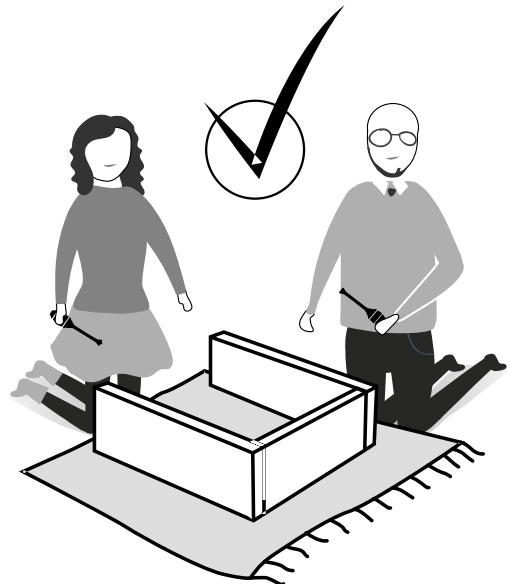
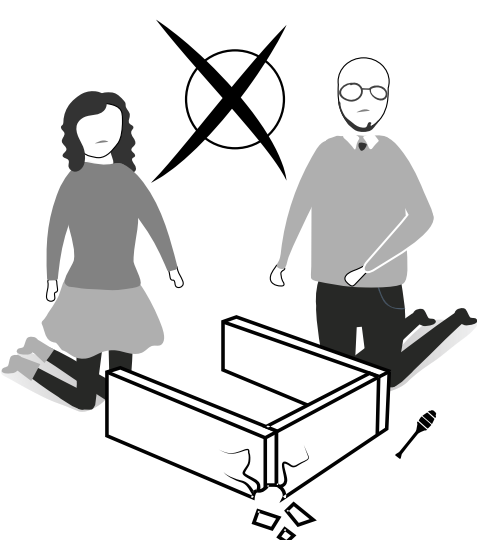
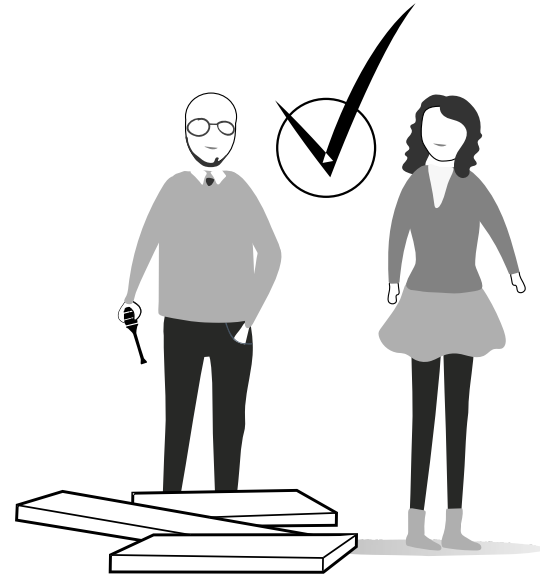
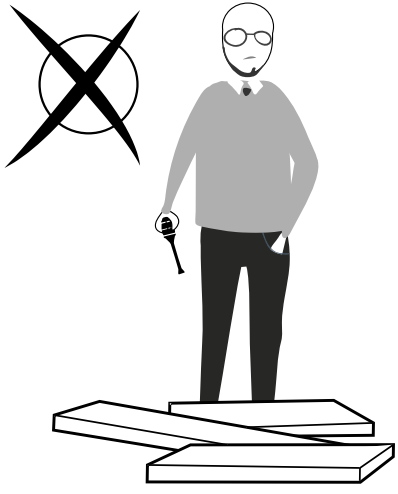

ATTENTION !!

Minifix is the main connection material used in our products.
Before starting assembly, please check the drawings below.

A04

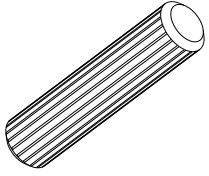

A23

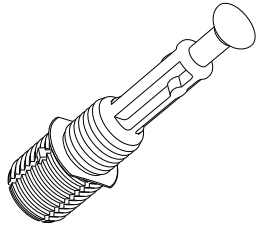

A22

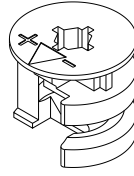

A12

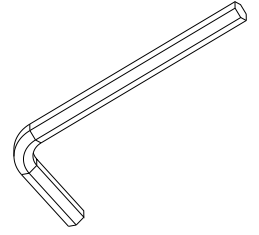

1

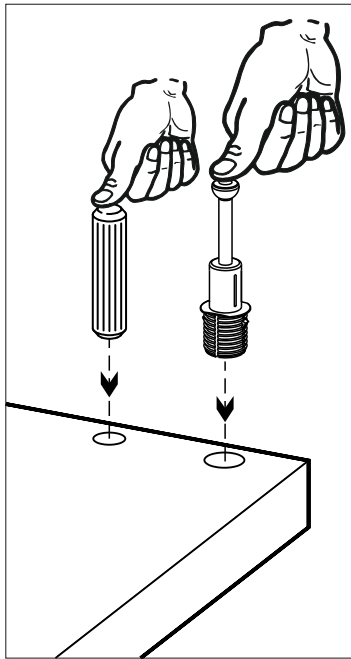

2

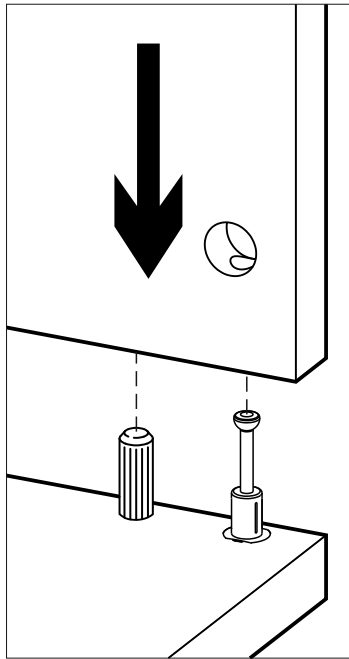

3

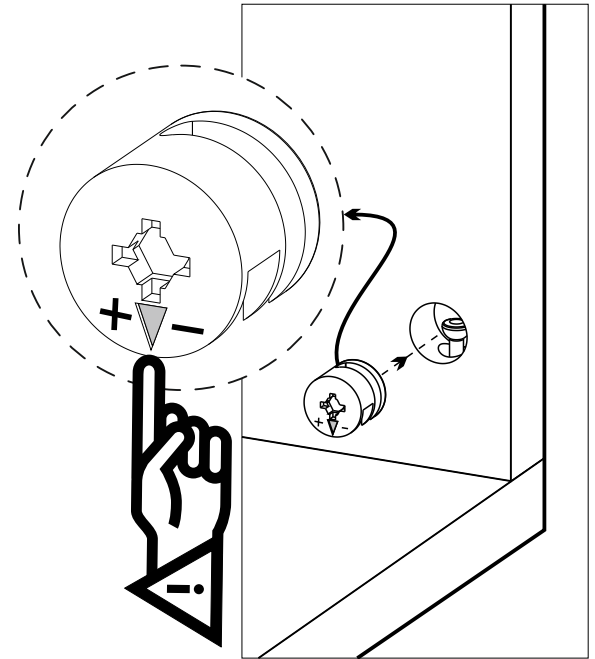



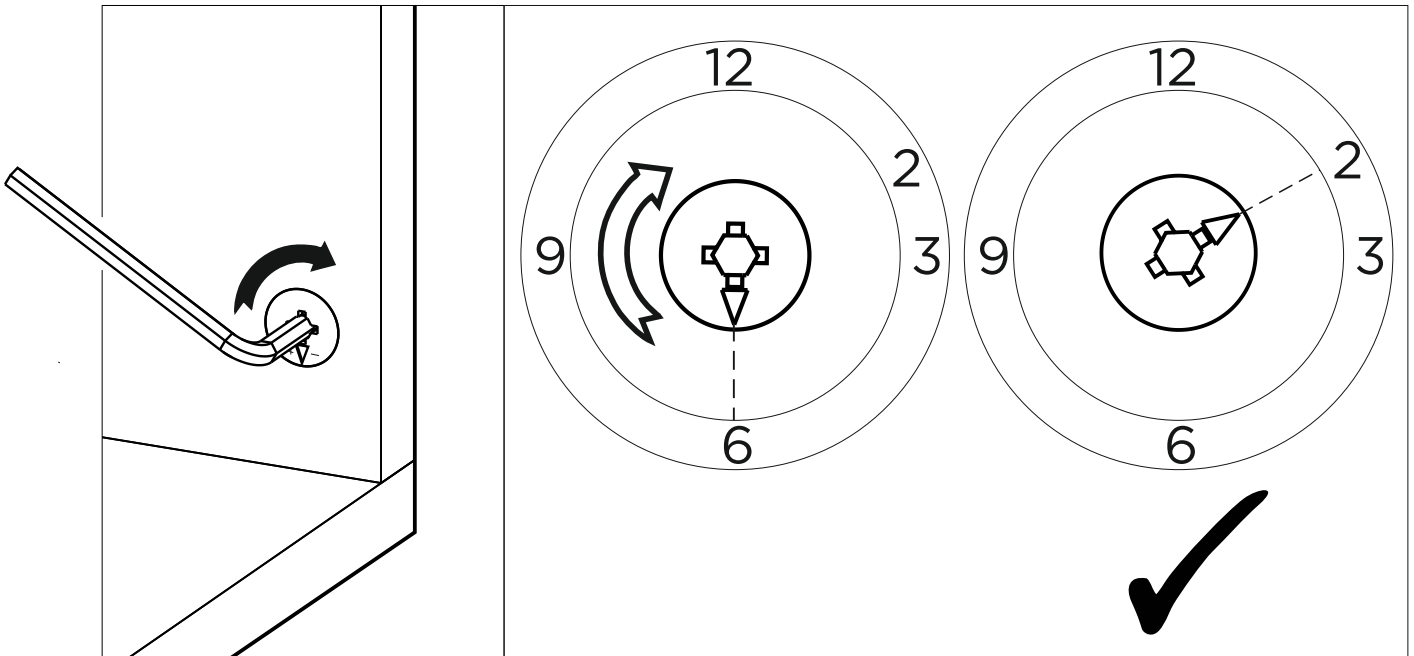



4

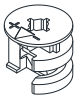
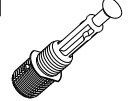
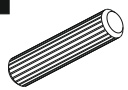
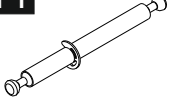
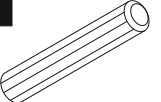
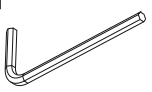

Follow the installation steps in the order as shown.
Position the parts as shown in the installation guide steps.

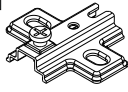

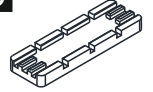
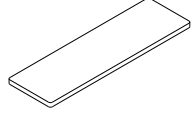
ACCESSORY LIST

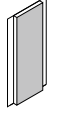
A22 Minifix k18  38x	A23 Minifix M10  30x	A04 Ø8  34x	A14 DFM6-86  4x	A41 Ø8x55  4x
A12 Allen  1x	C01 DM  4x	C04 Mtk  4x	A18 3,5x18  16x	A08 5mm  6x
Matress 1060x340x50  1x	A06 18mm  C1-38x	Y03 Ctpb  6x		

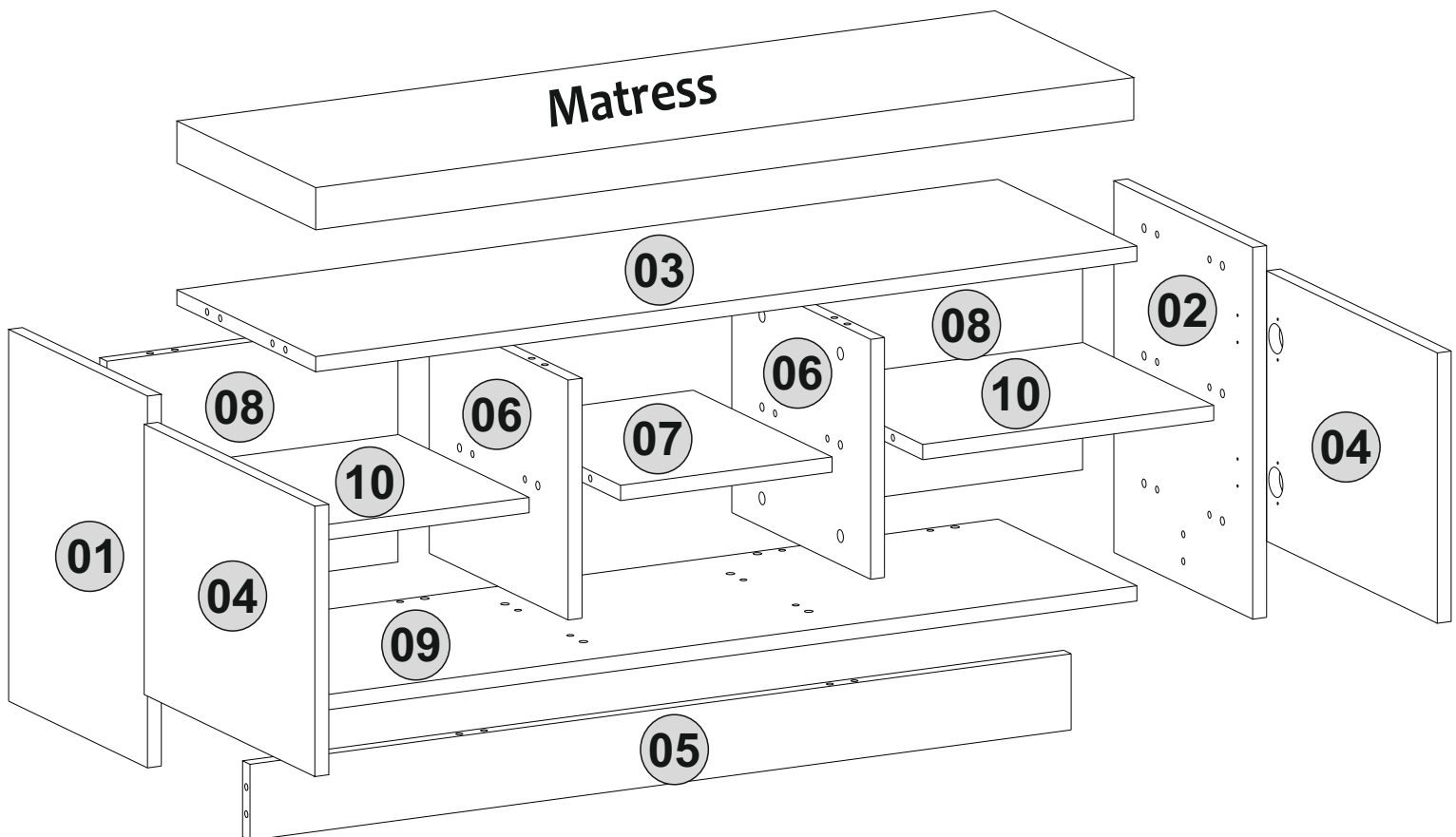

1. step

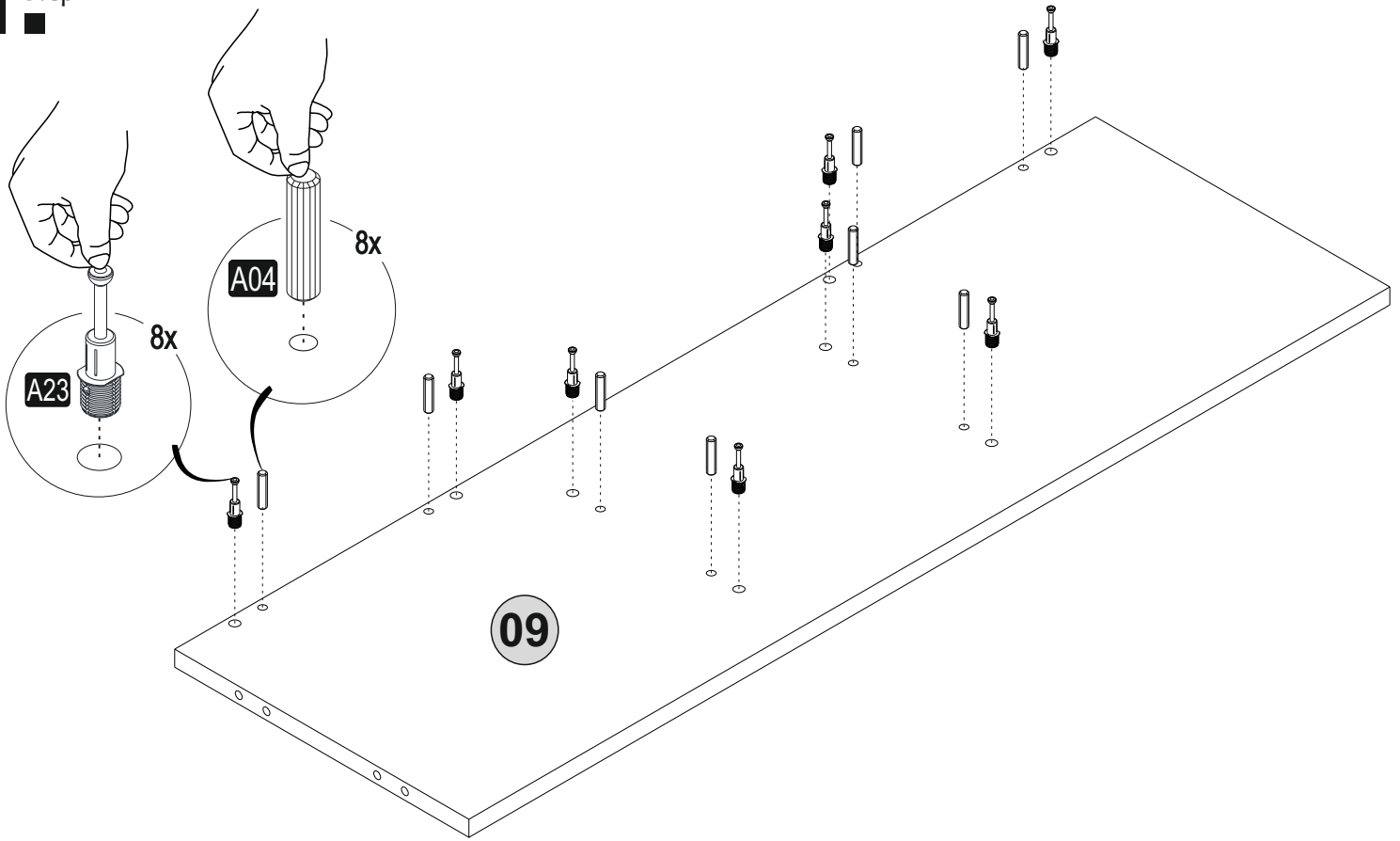

2. step

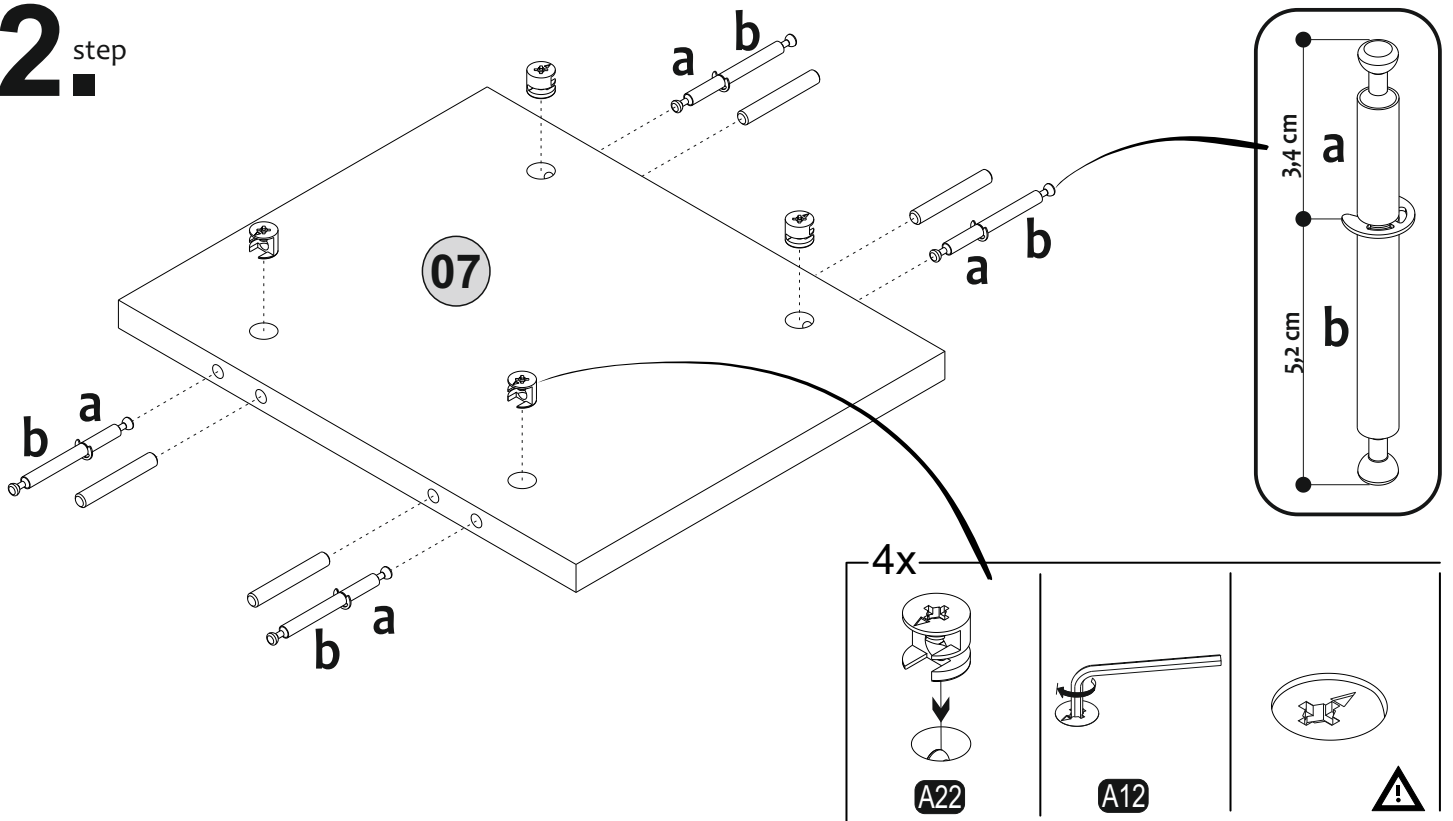

3. step

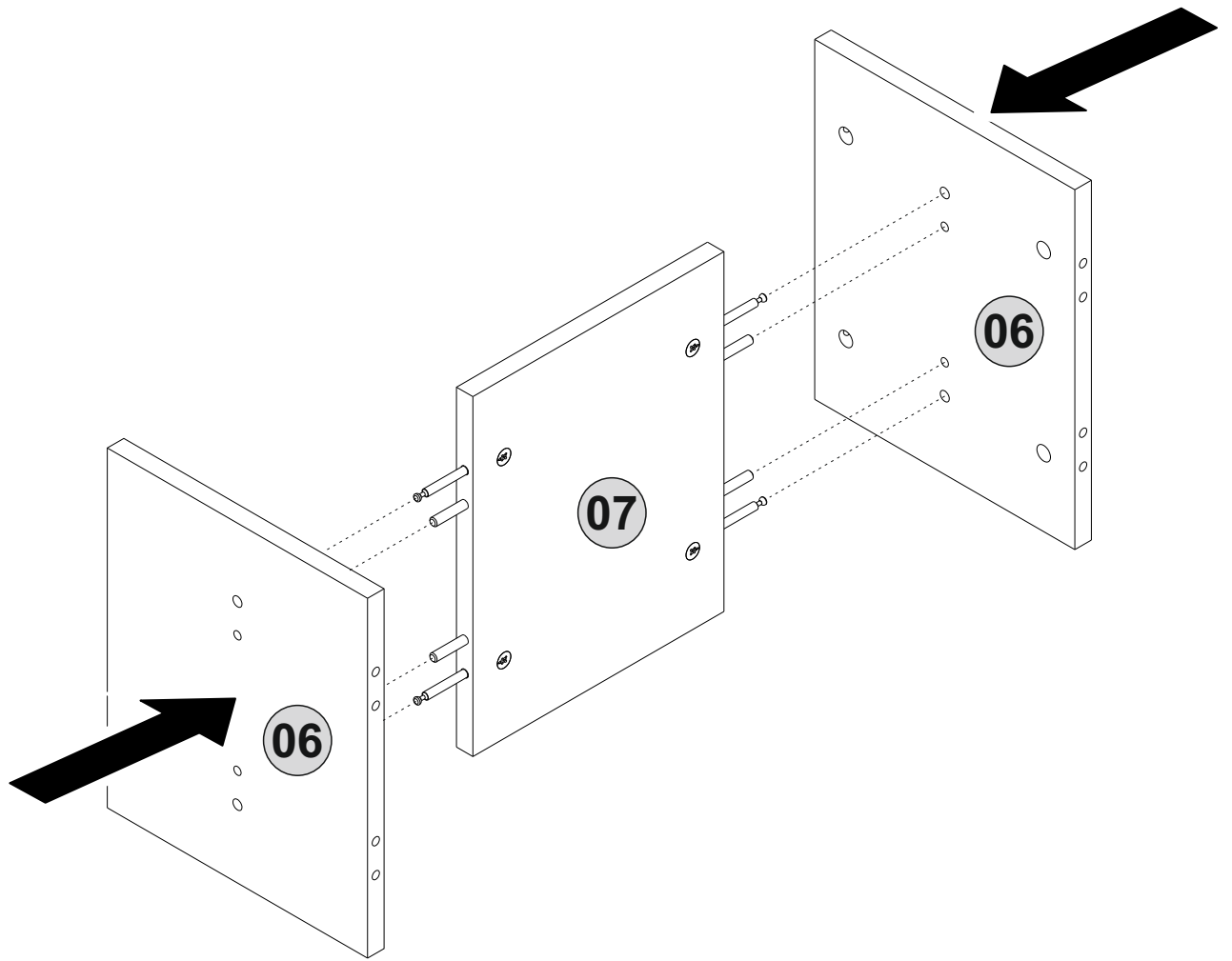

4. step

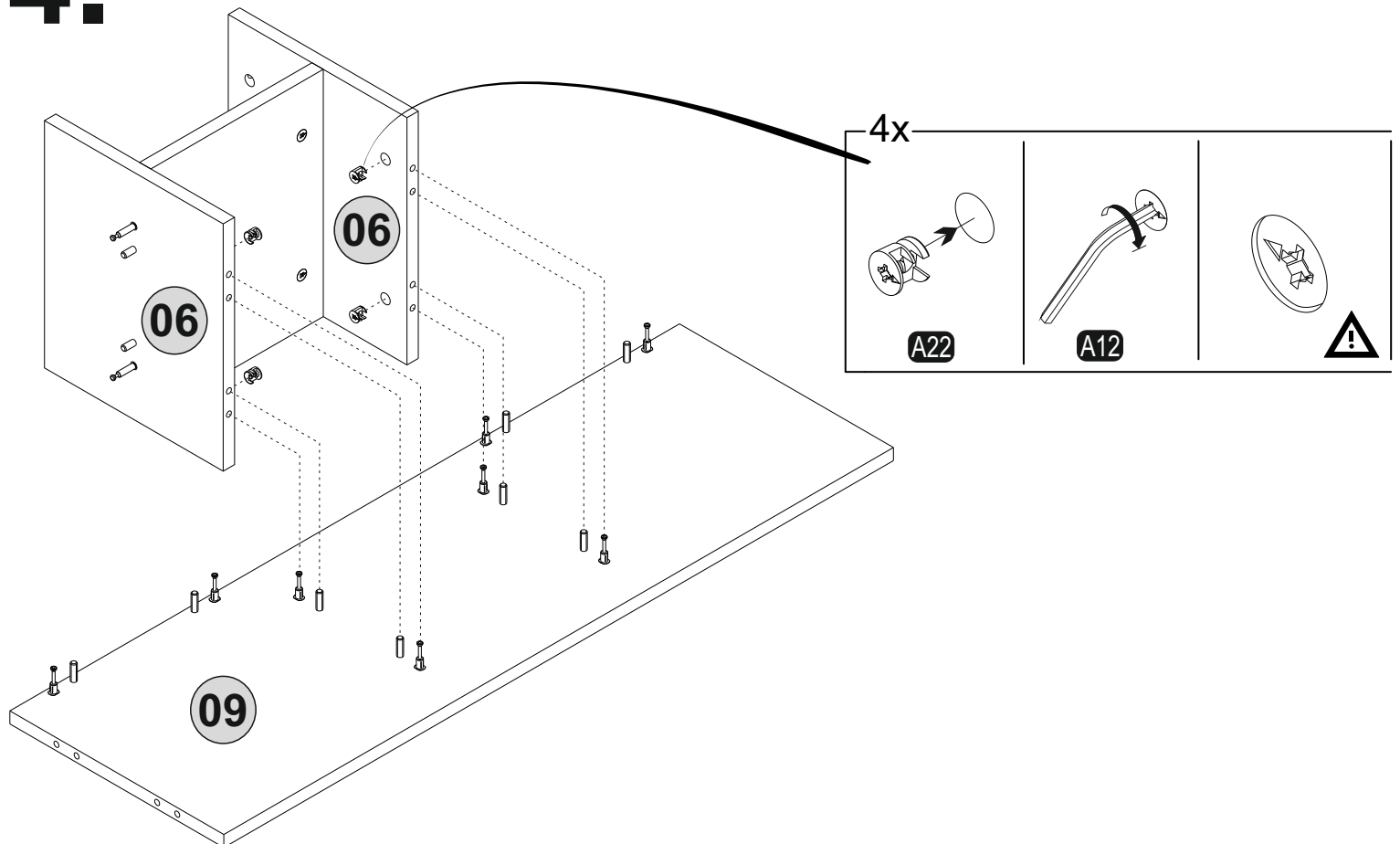

5. step

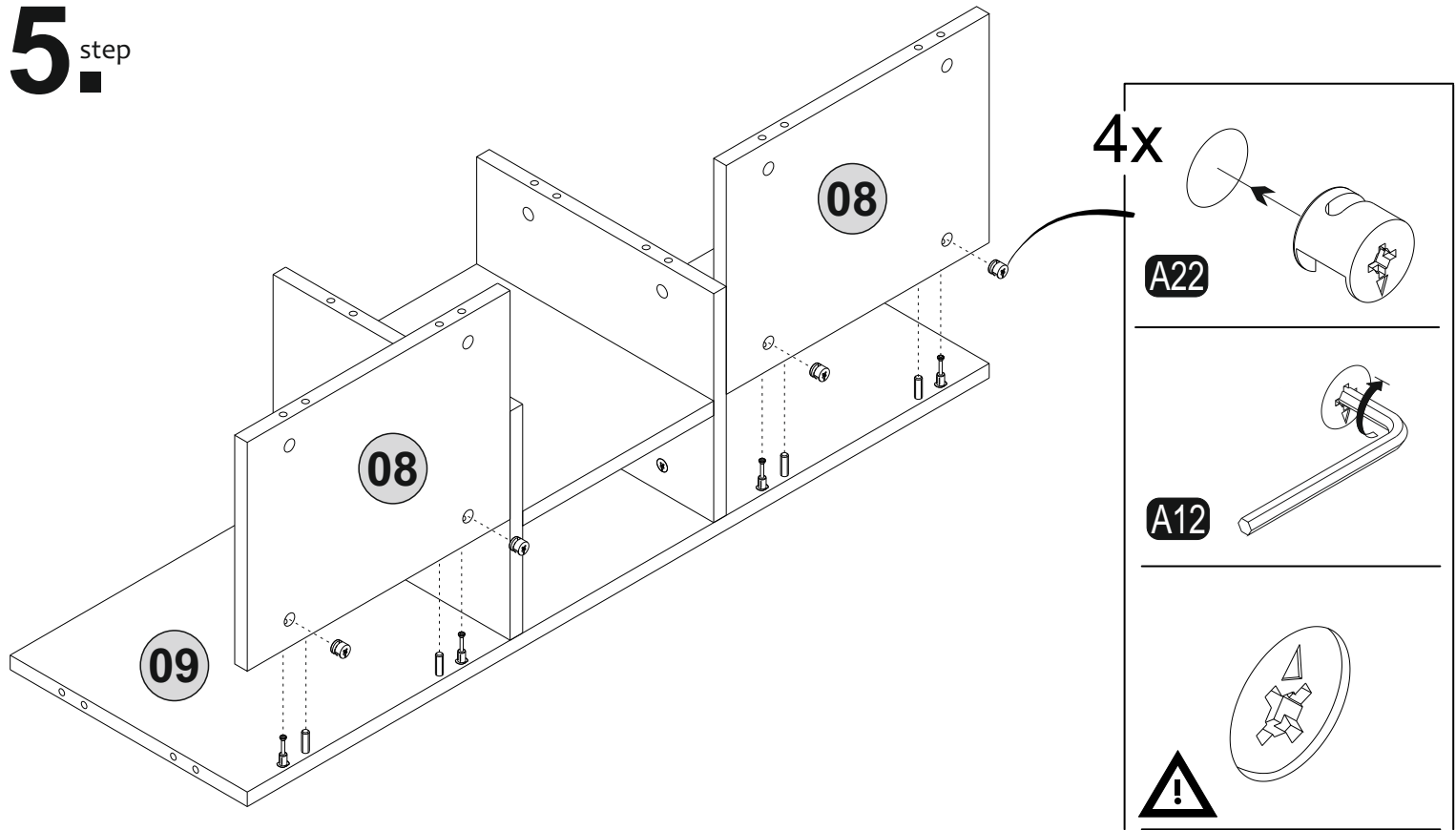

6. step

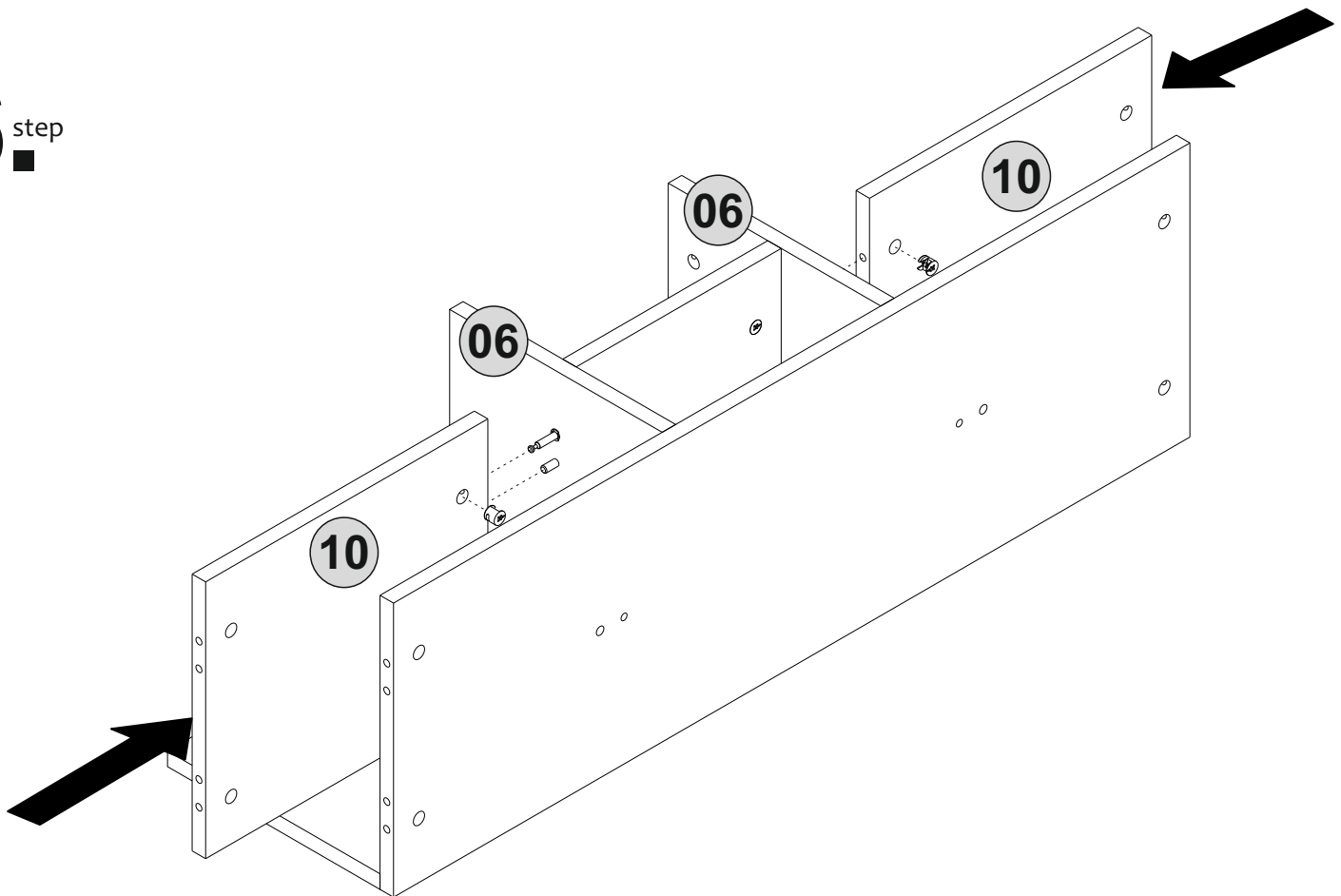

7. step

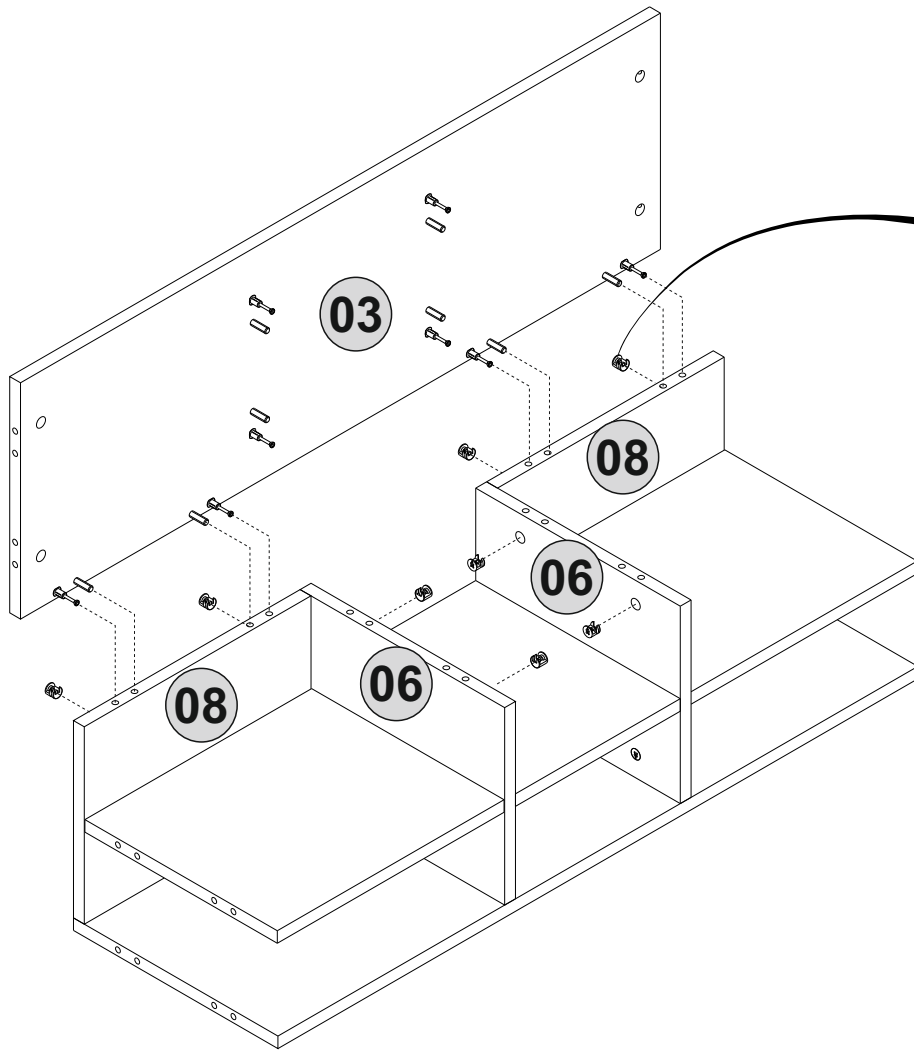

8x

A22

A12

!

8. step

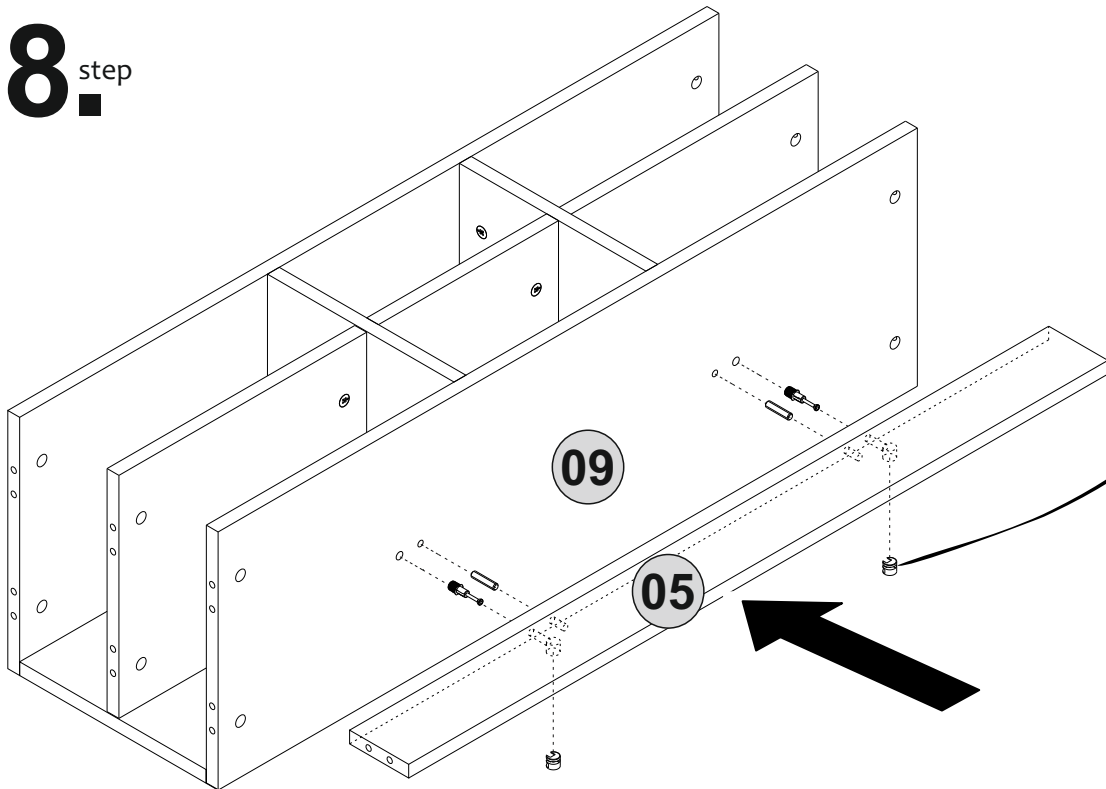

2x

A22

A12

!

9^{step}

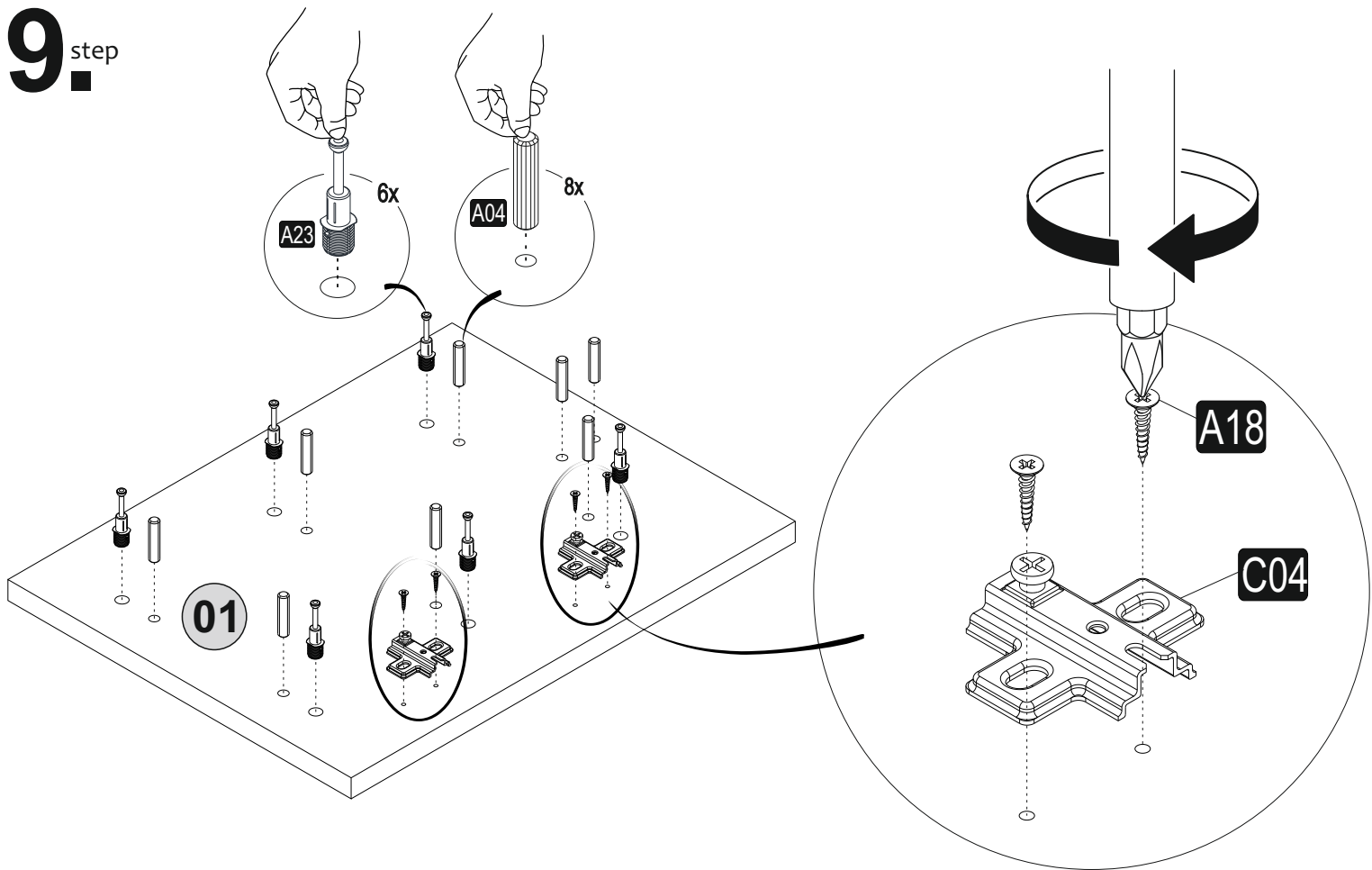

10^{step}

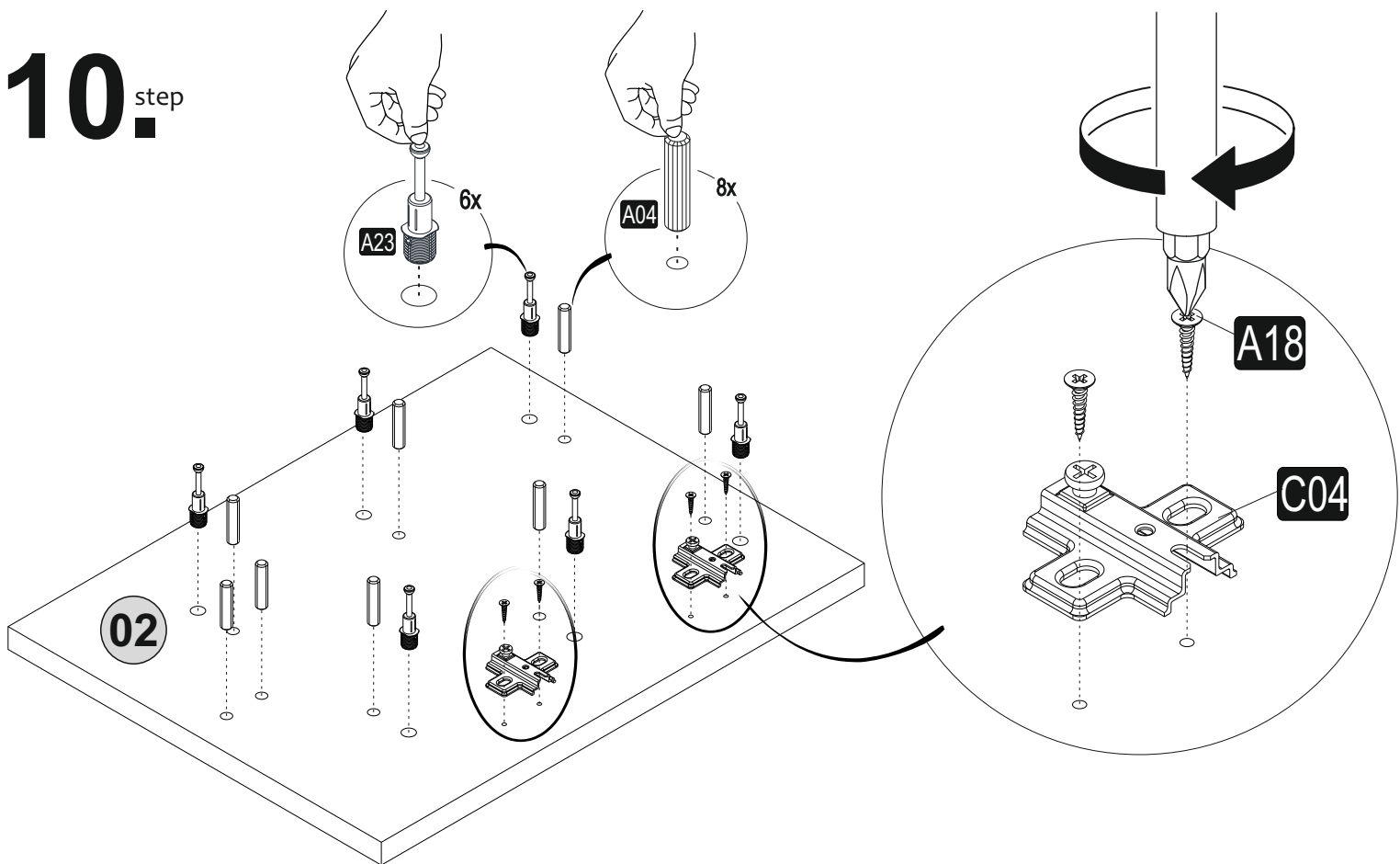

11.^{step}

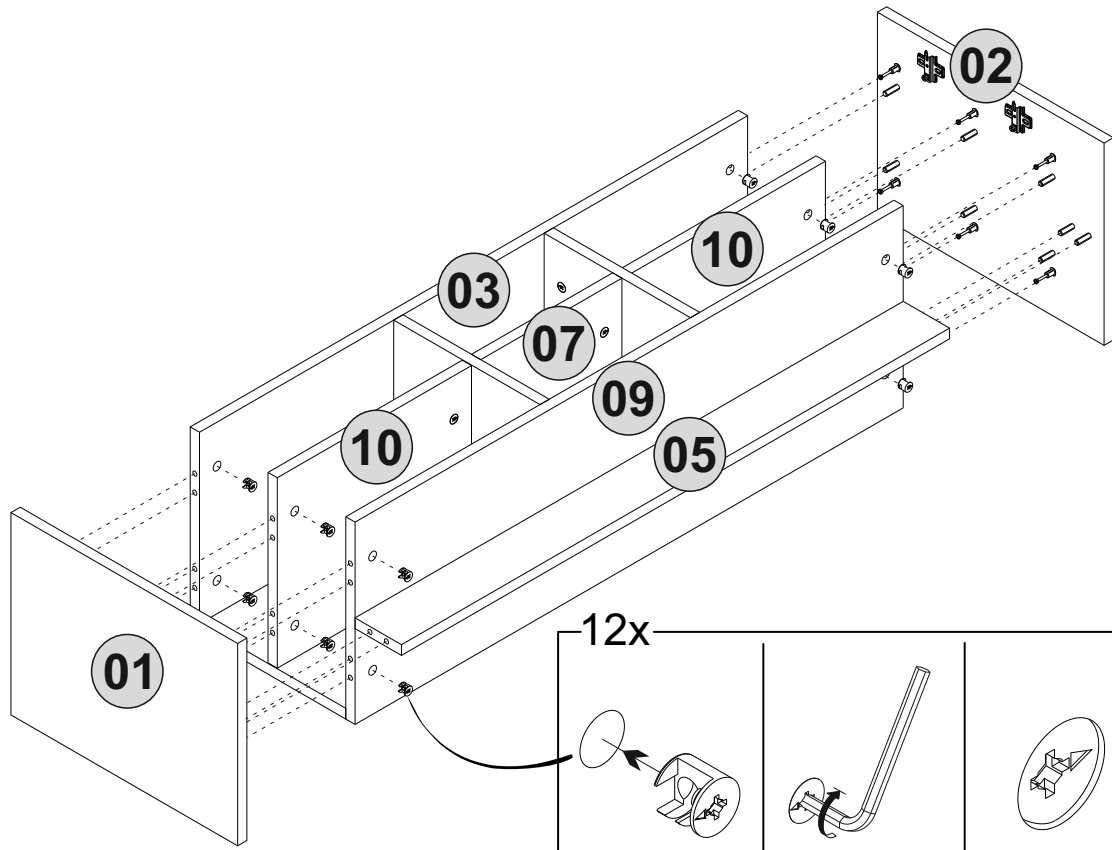

12.^{step}

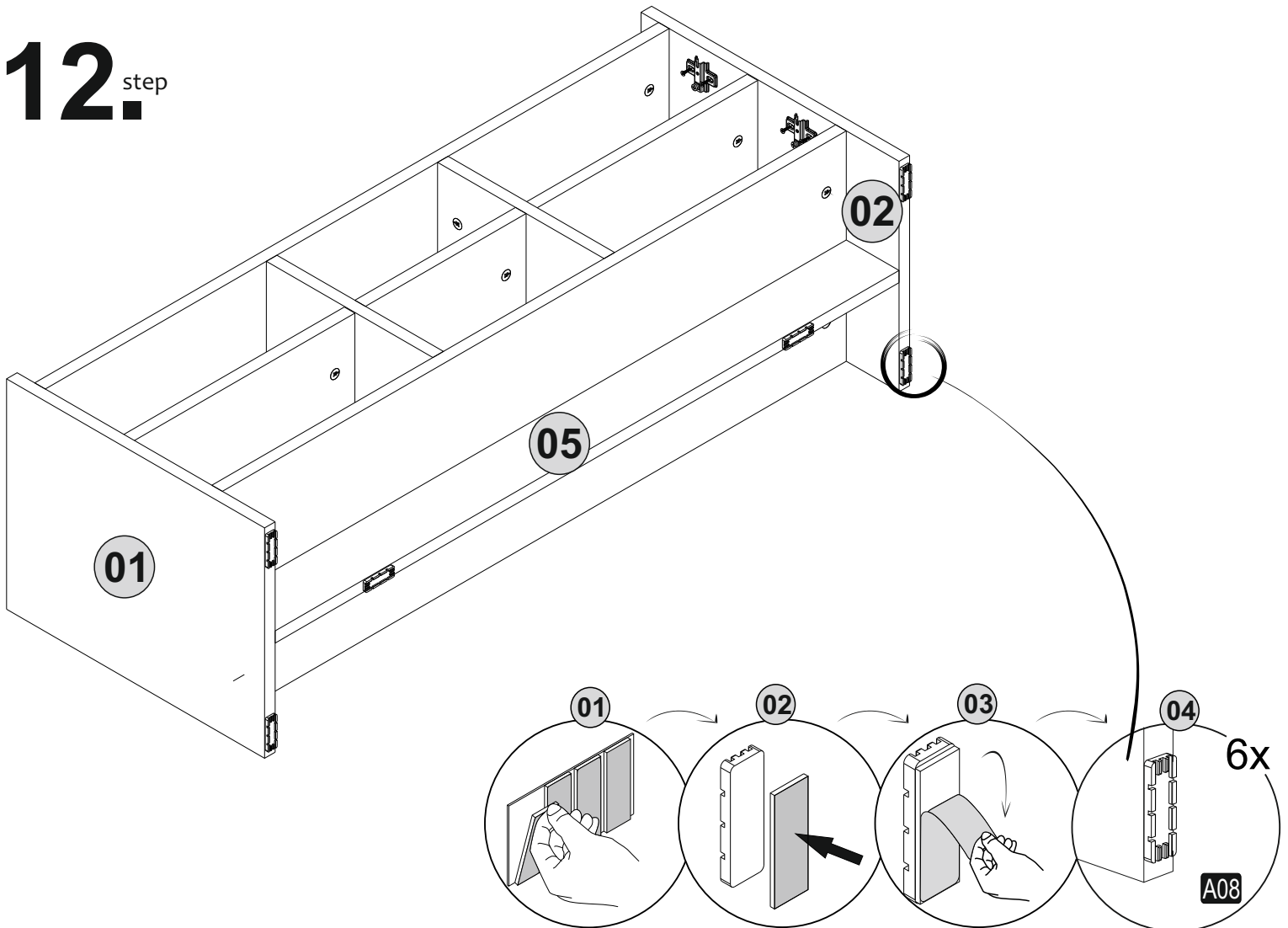

13.^{step}

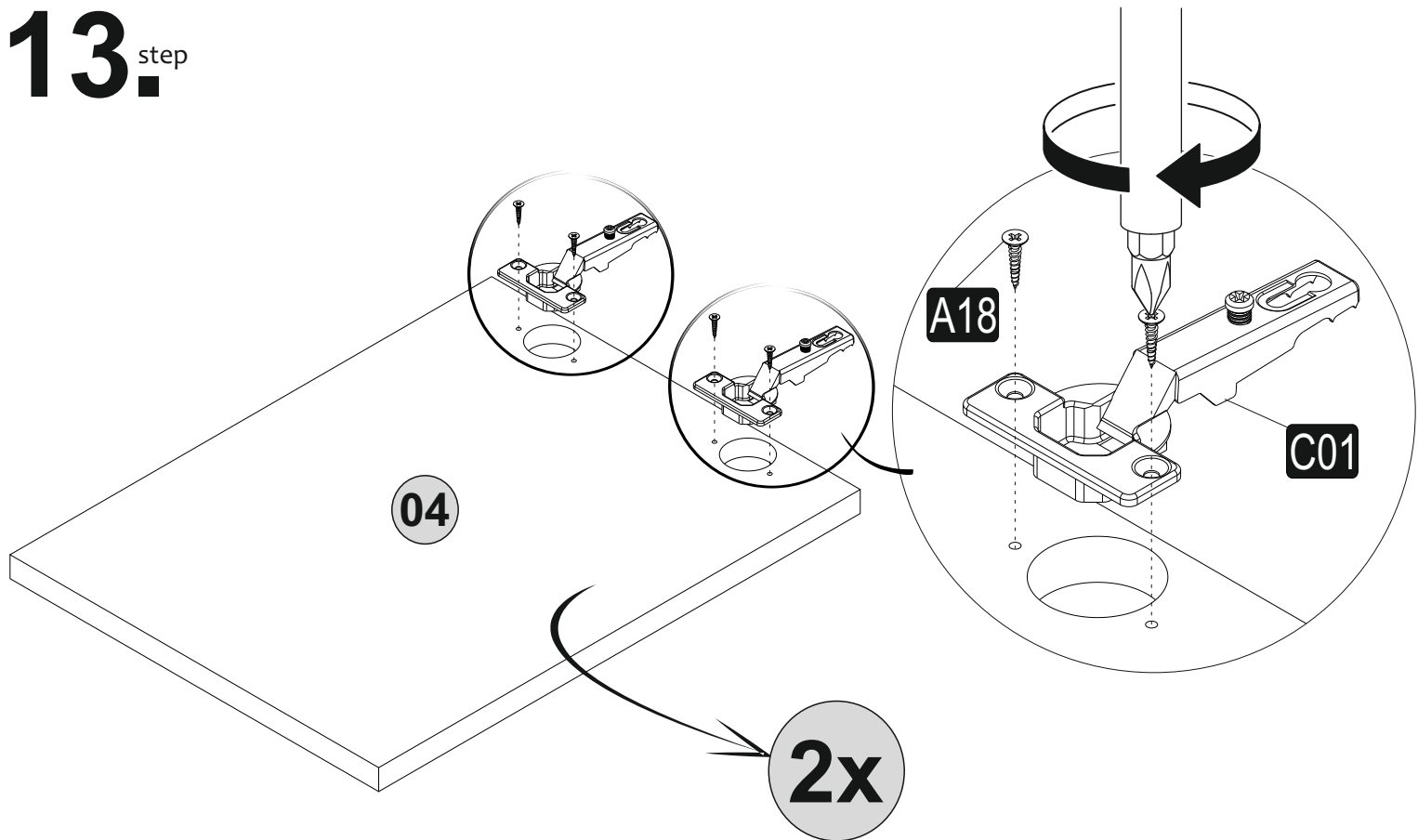

14.^{step}

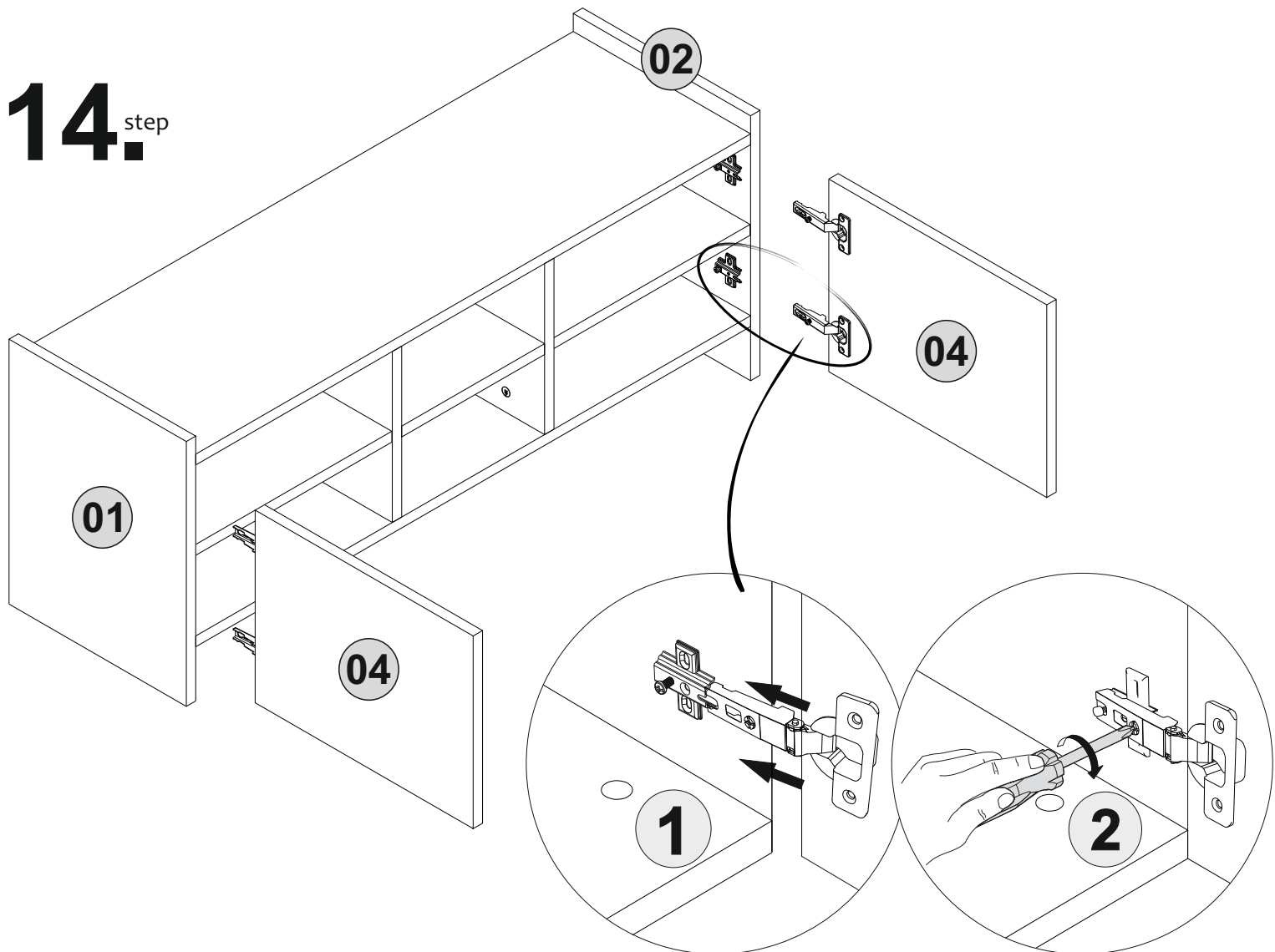

15^{step}

