

GP037-0039,2

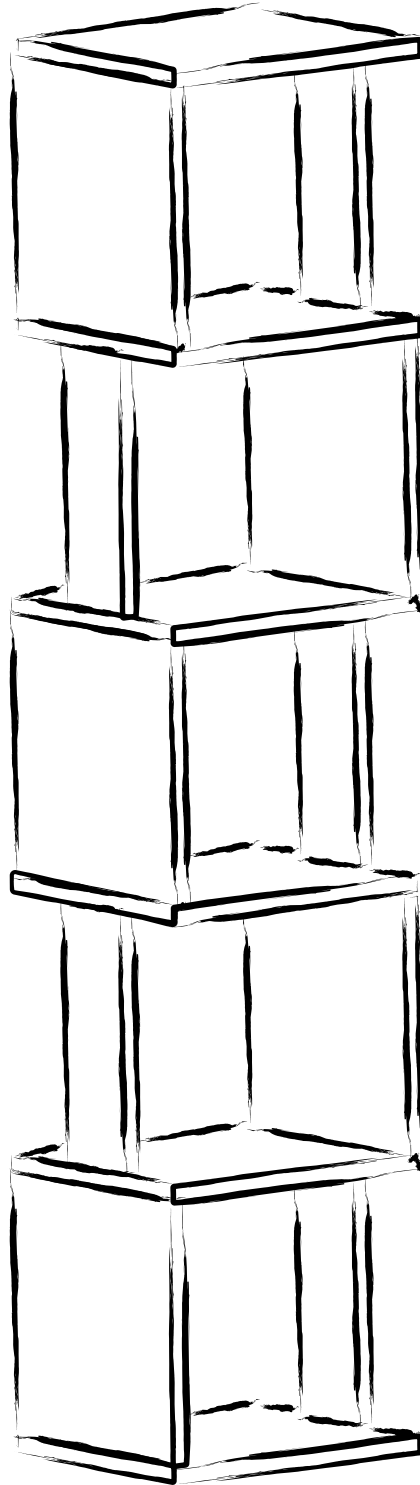

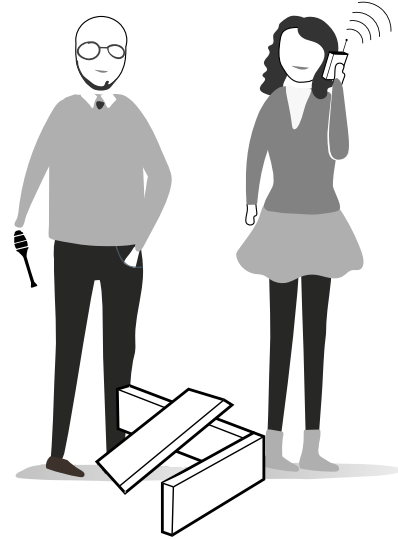
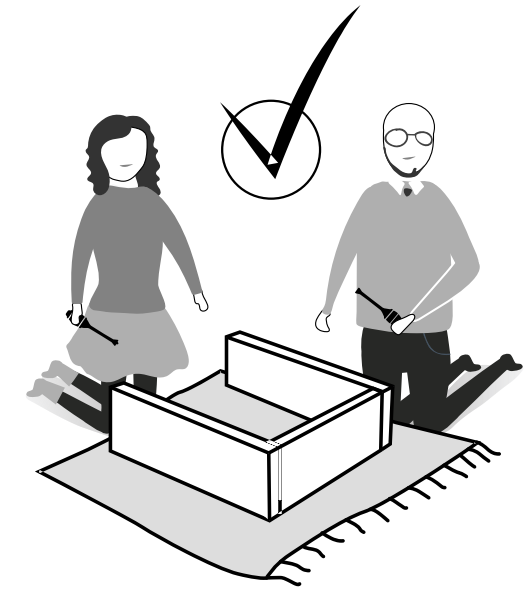
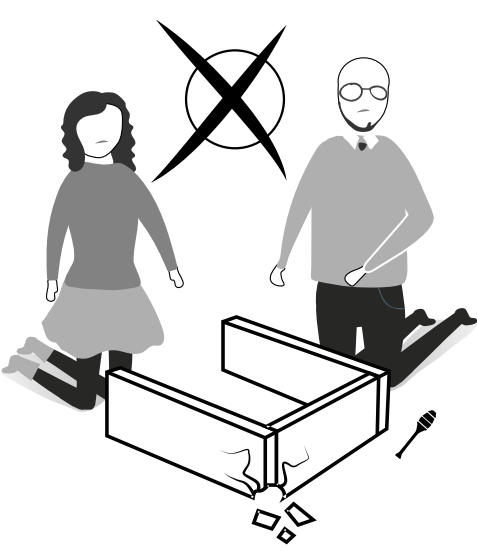
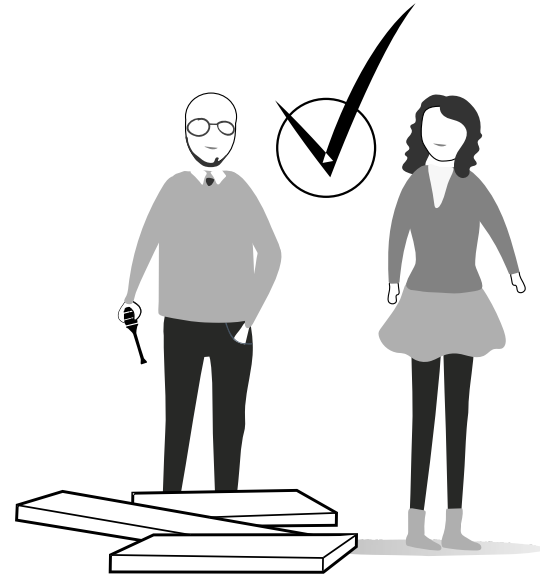
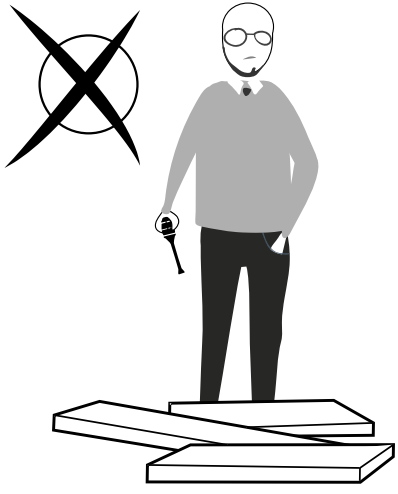

ATTENTION !!

Minifix is the main connection material used in ada products.
Before starting assembly, please check the drawings below.

A04

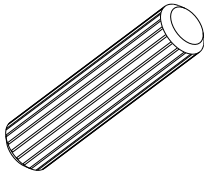

A23

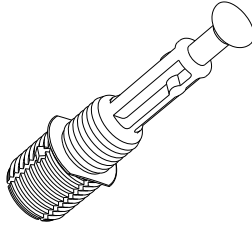

A22

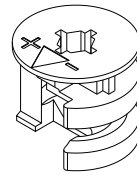

1

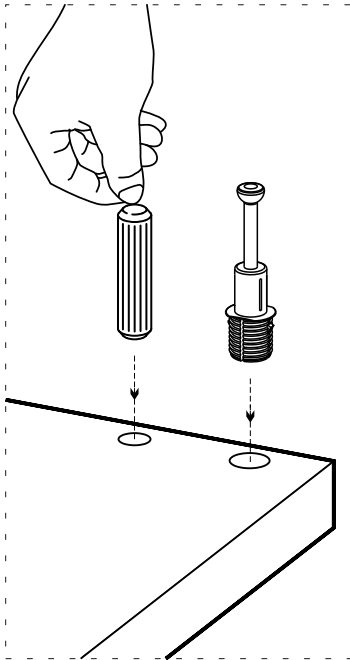

2

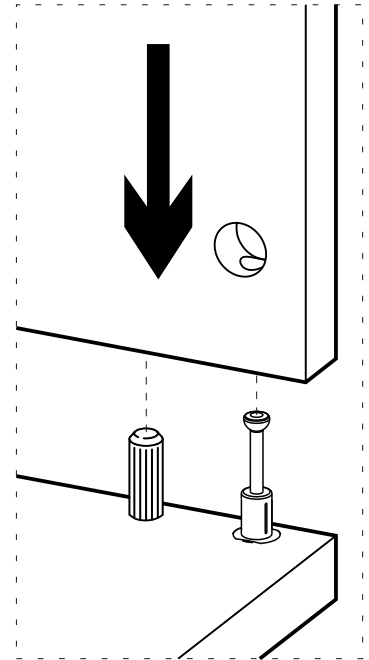

3

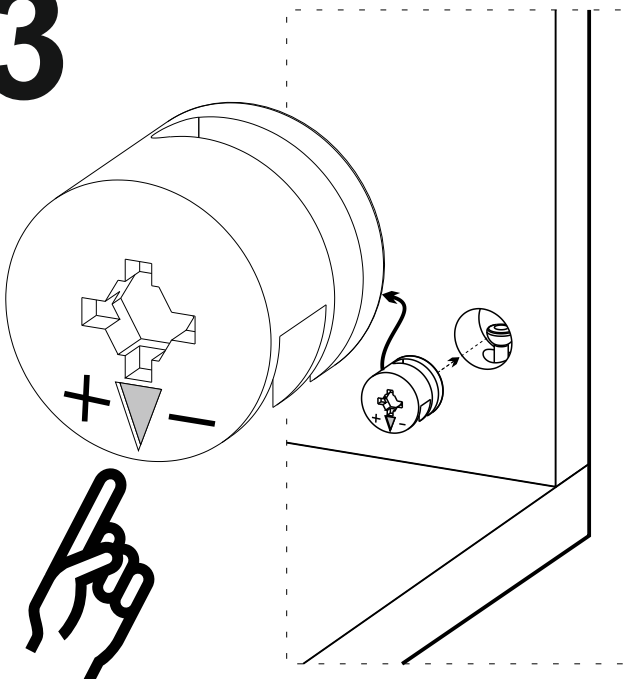



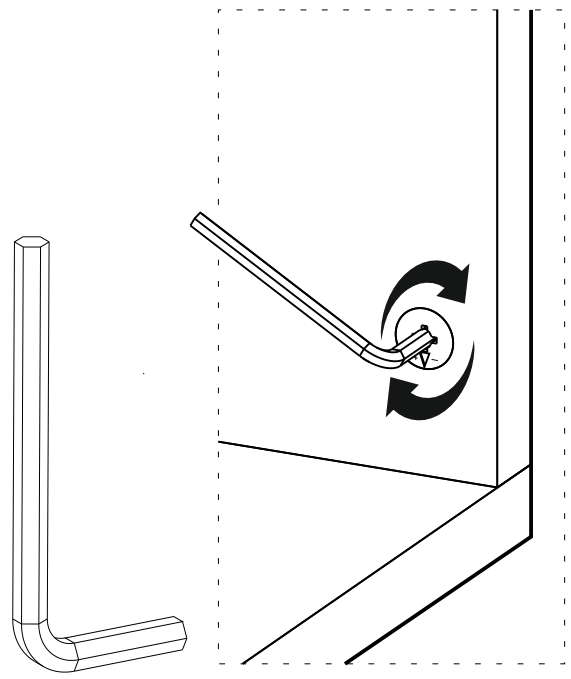





4

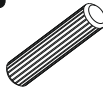

Follow the installation steps in the order as shown.
Position the parts as shown in the installation guide steps.

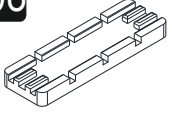

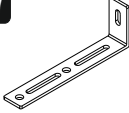
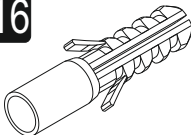
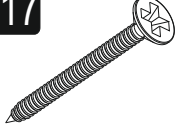
ACCESSORY LIST

A22  Minifix k18 40x	A23  Minifix M10 40x	A04  Ø8 30x	A12  4 SW 1x	A08  4x
A06  18 mm C1 20x C2 20x	A87  15x90x30 1x	A16  Ø8 1x	A17  4x50 1x	A18  3,5x18 2x

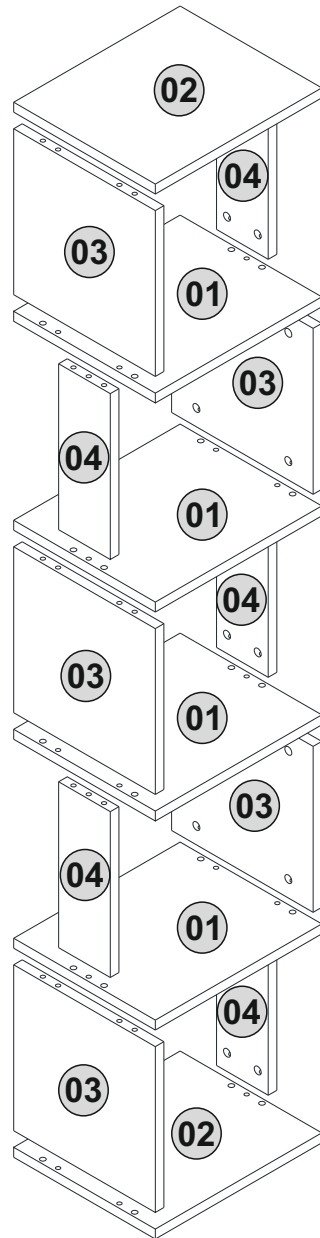

1. step

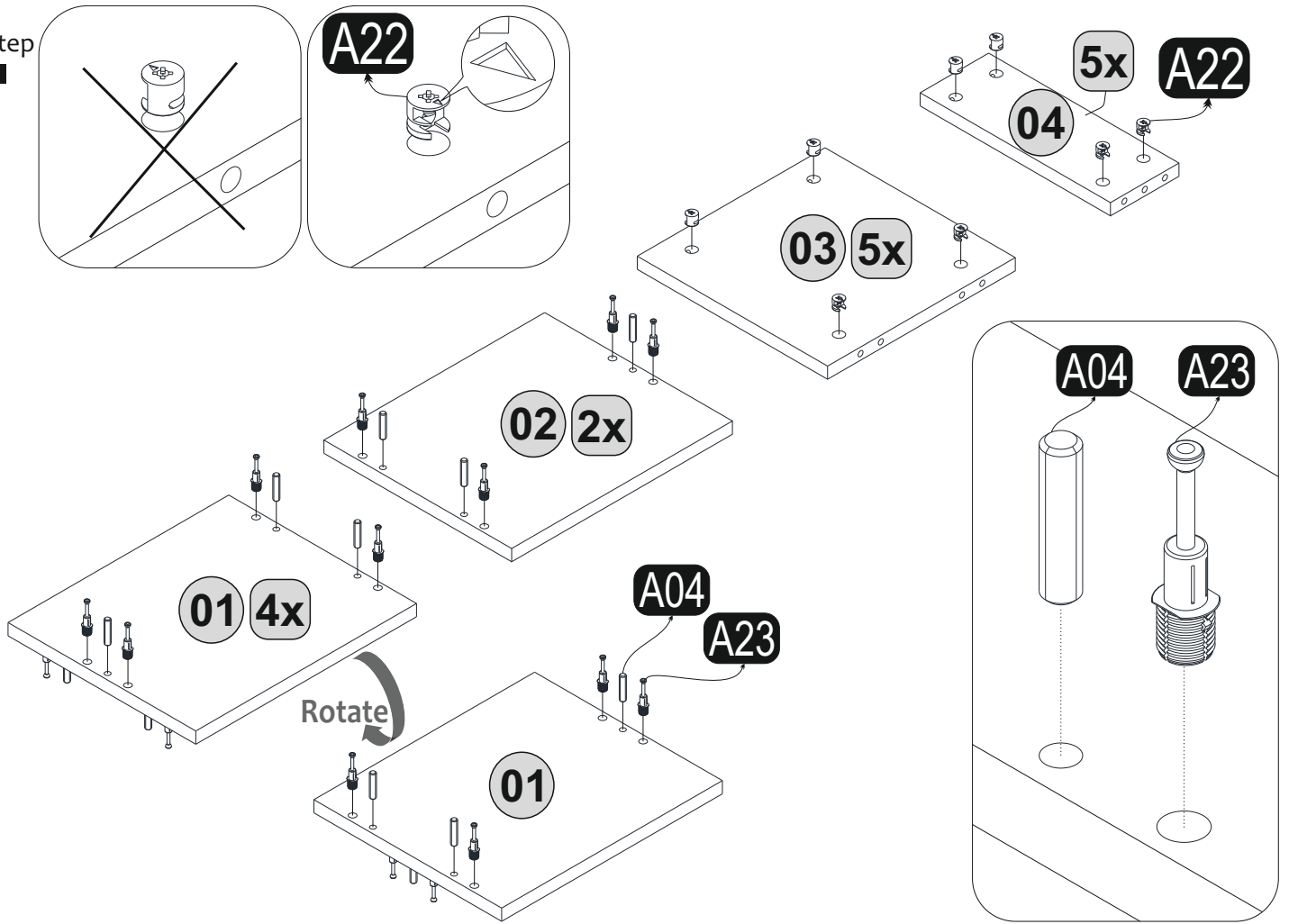

2. step

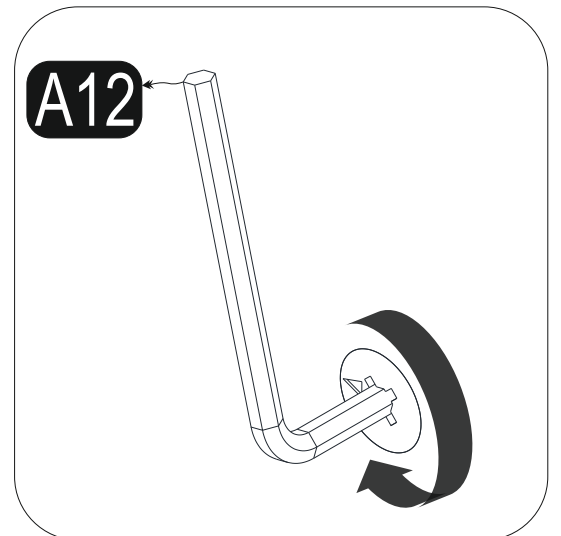
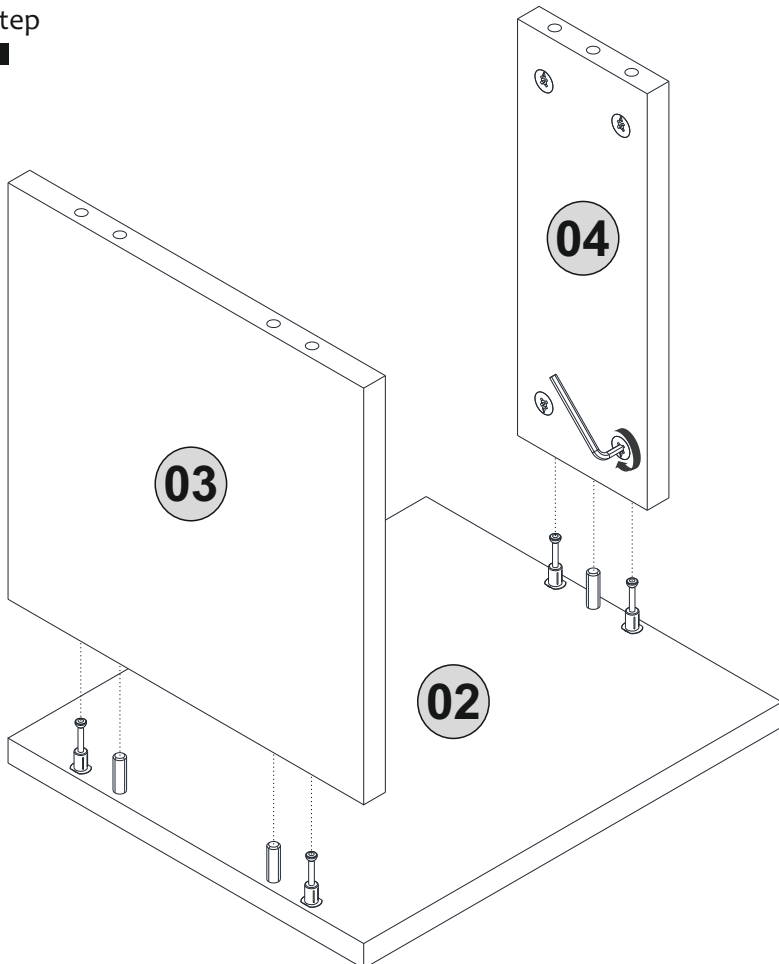

3 step

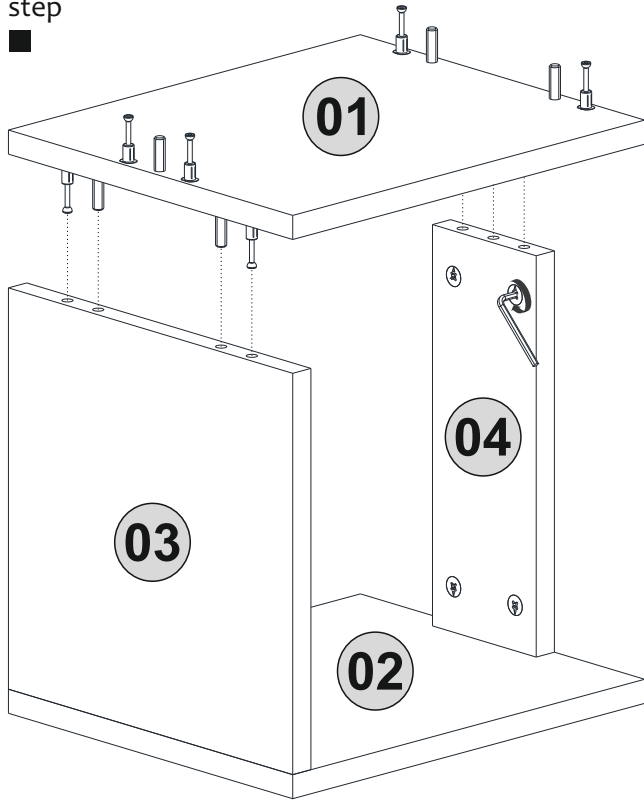

4 step

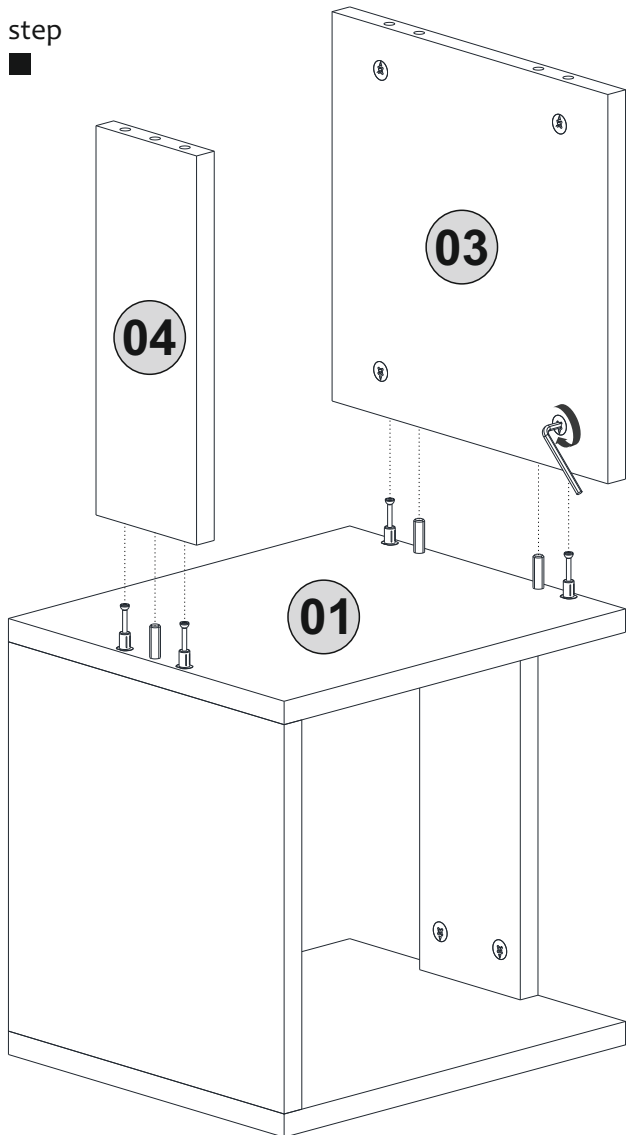

5 step

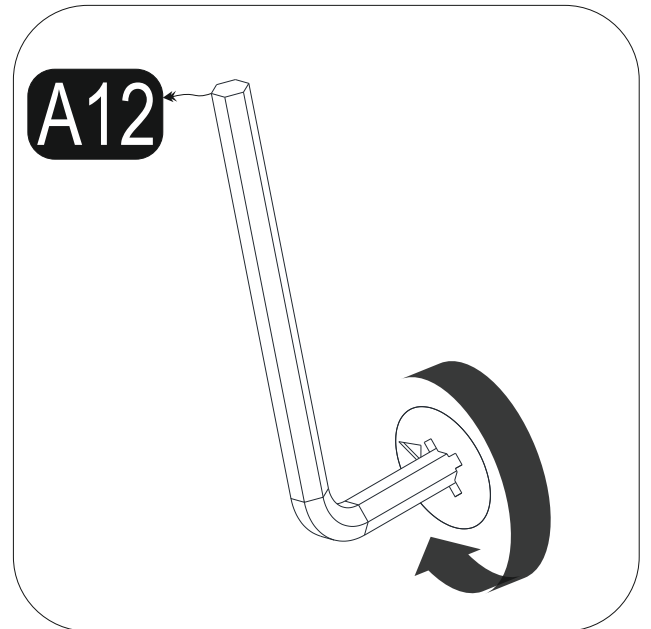
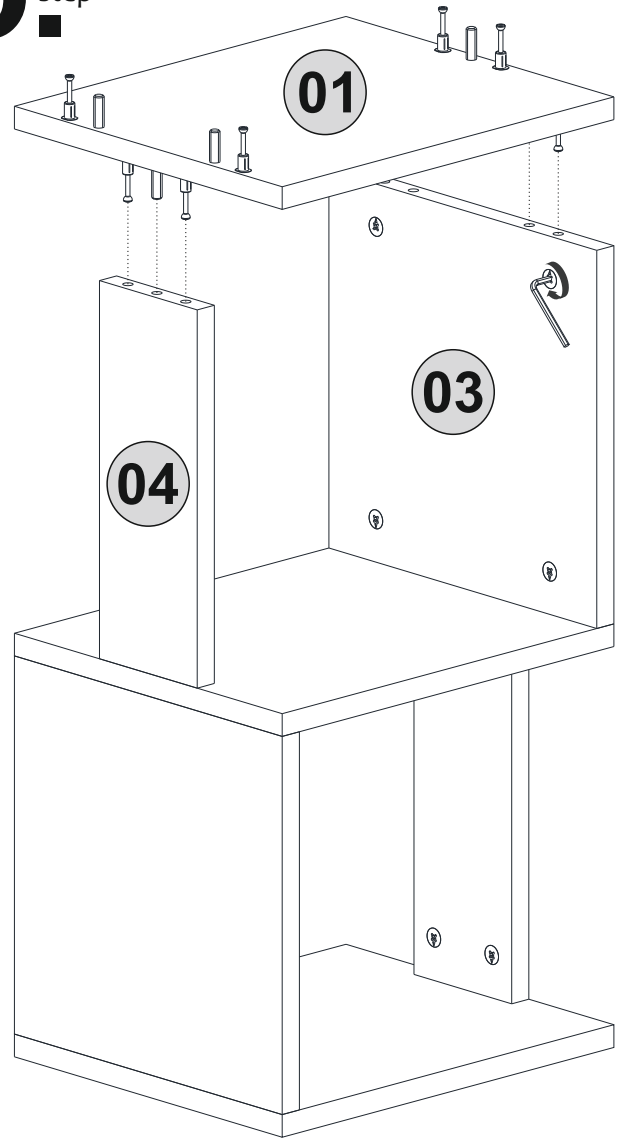

6^{step}

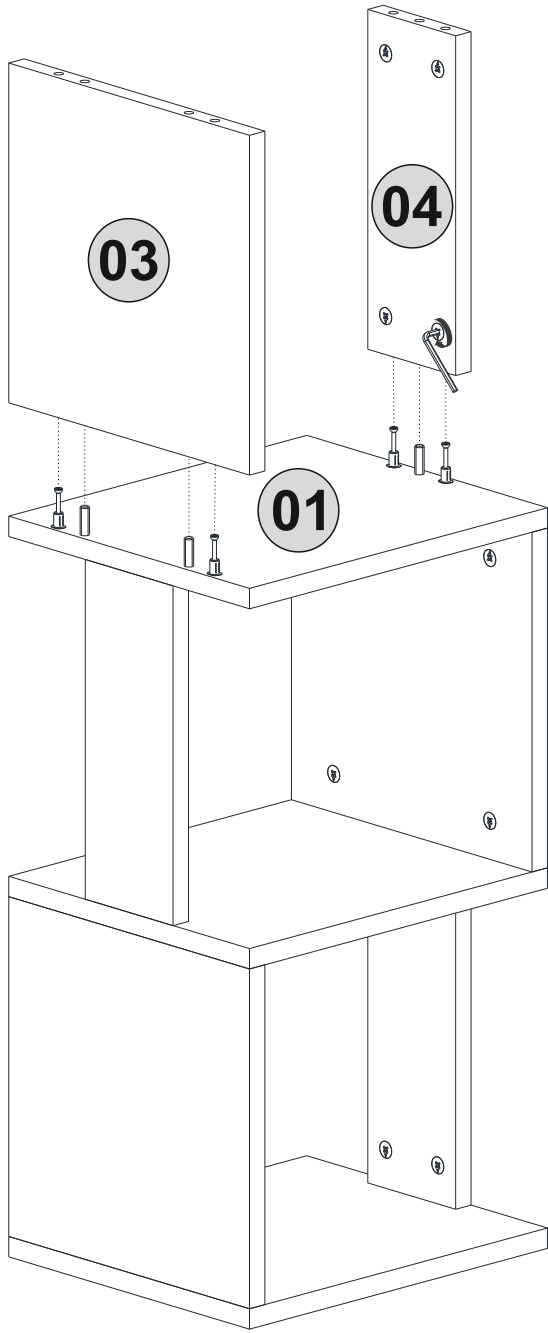

7^{step}

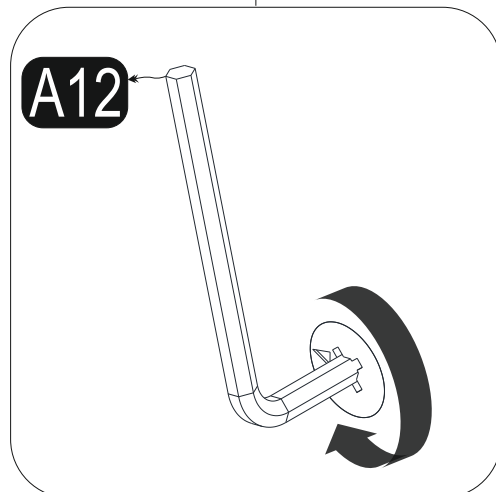
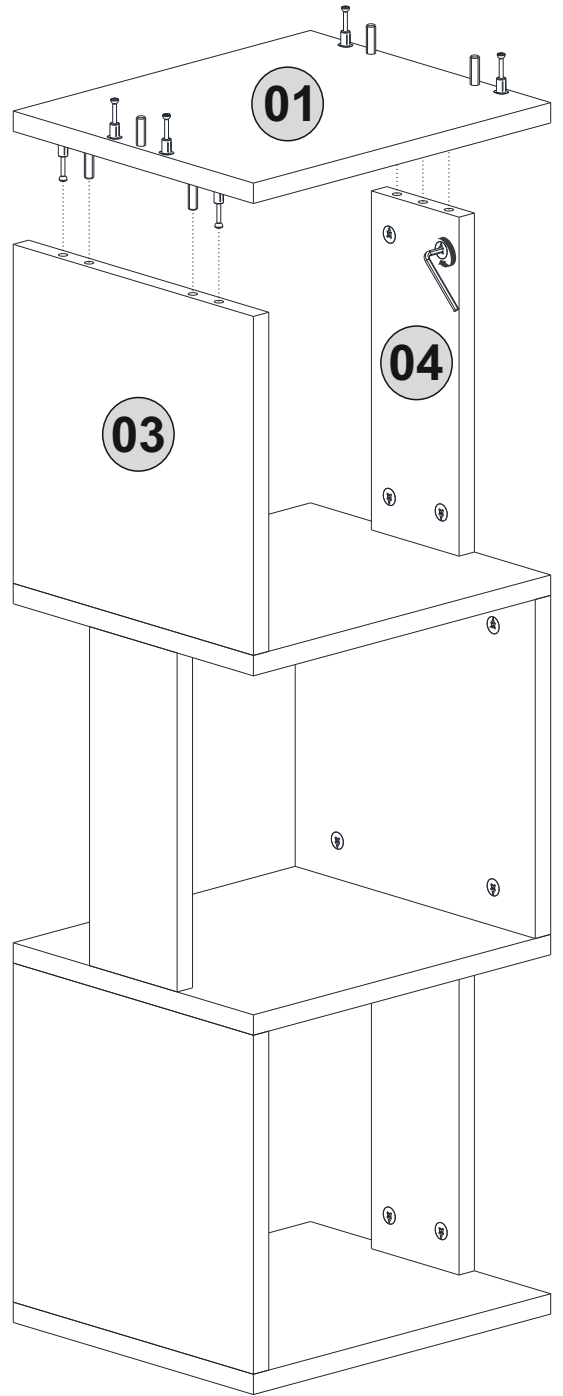

8 step

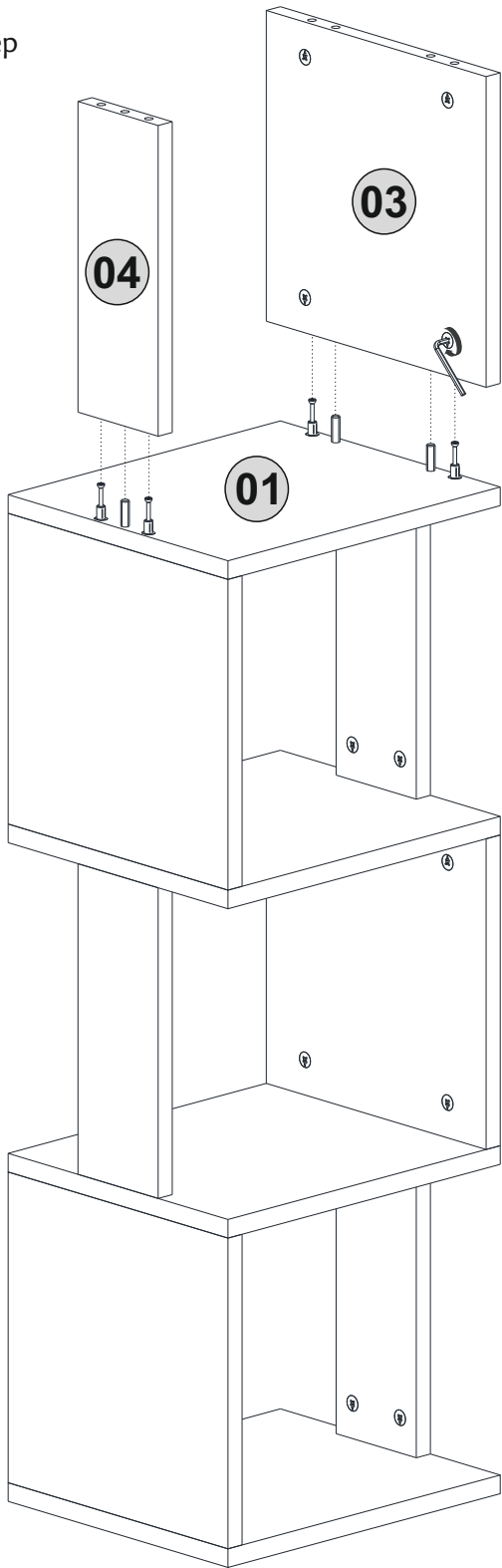

9 step

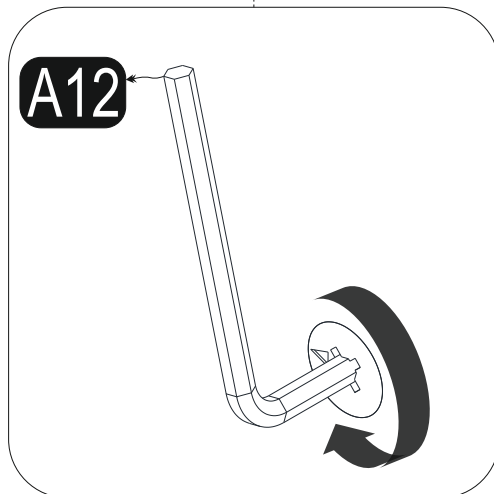
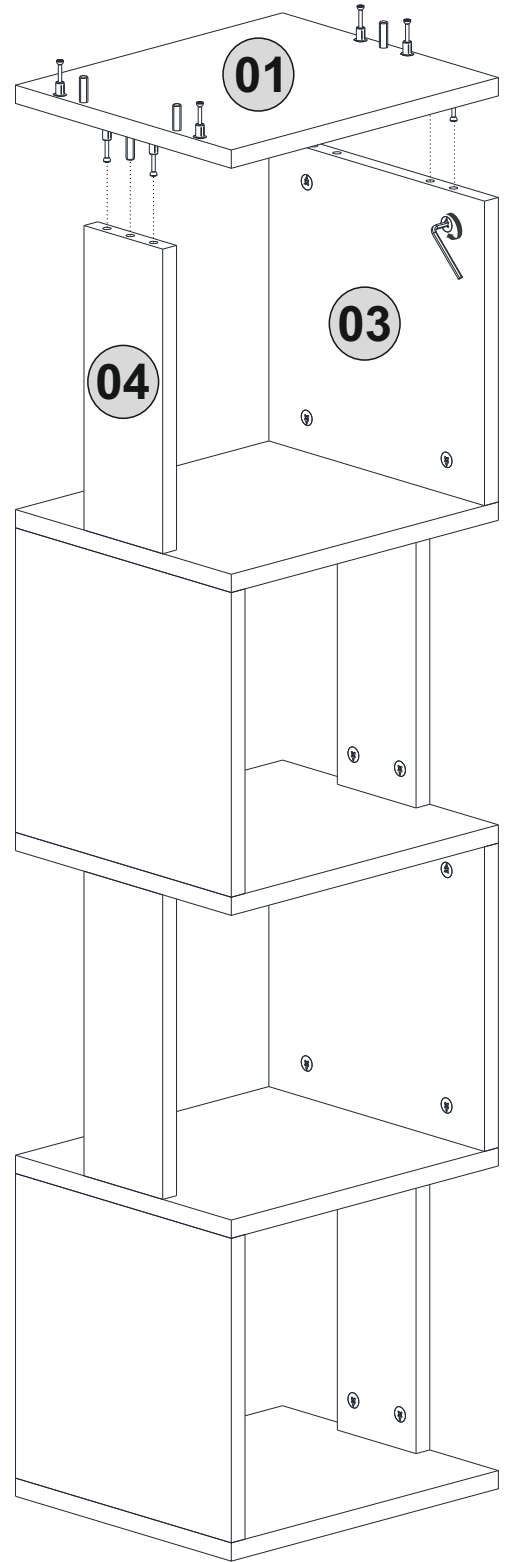

10.

step

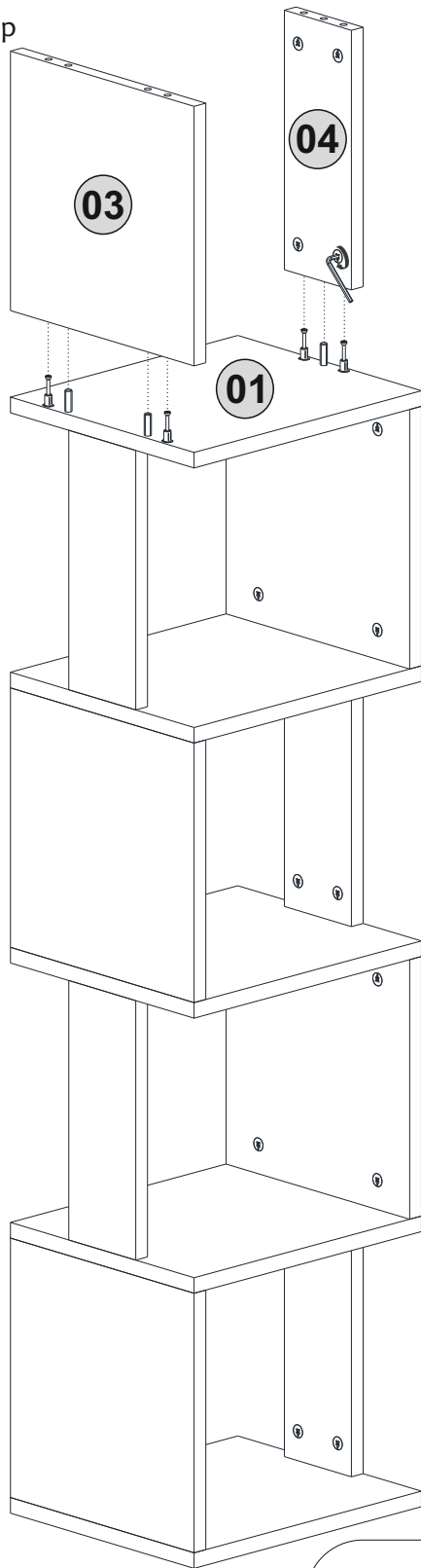

11.

step

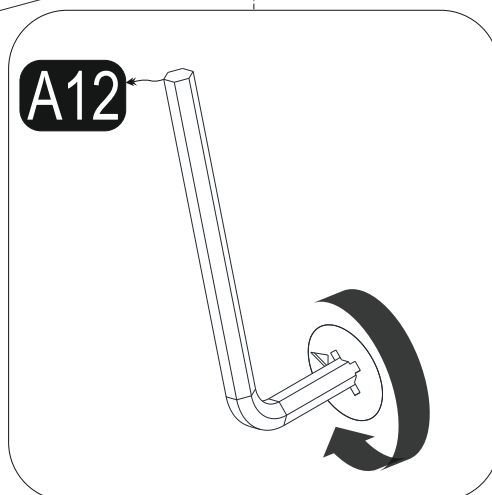
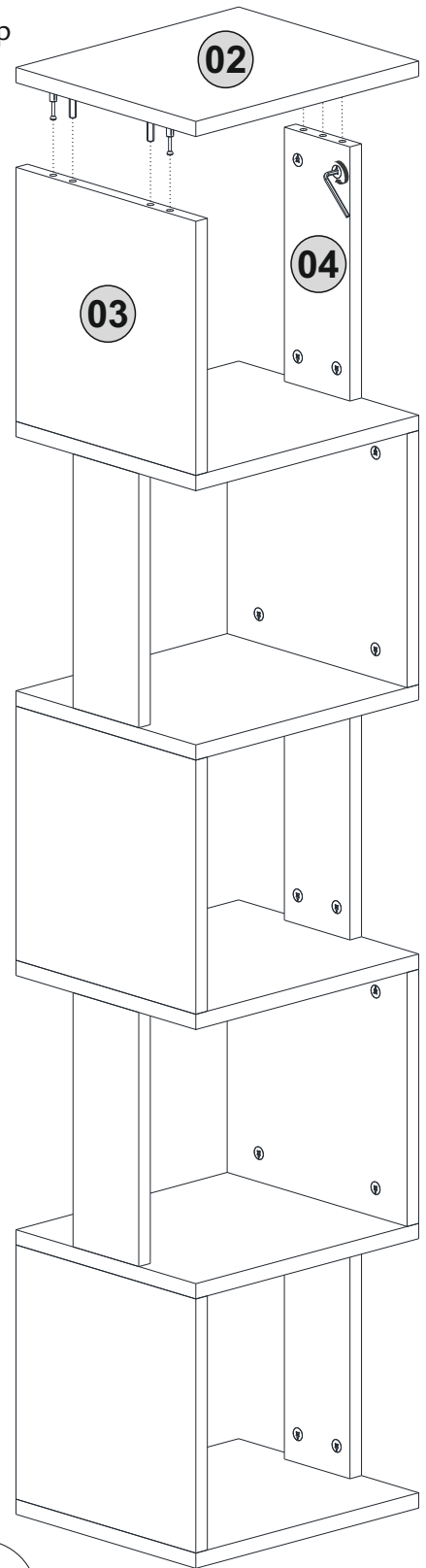

12.^{step}

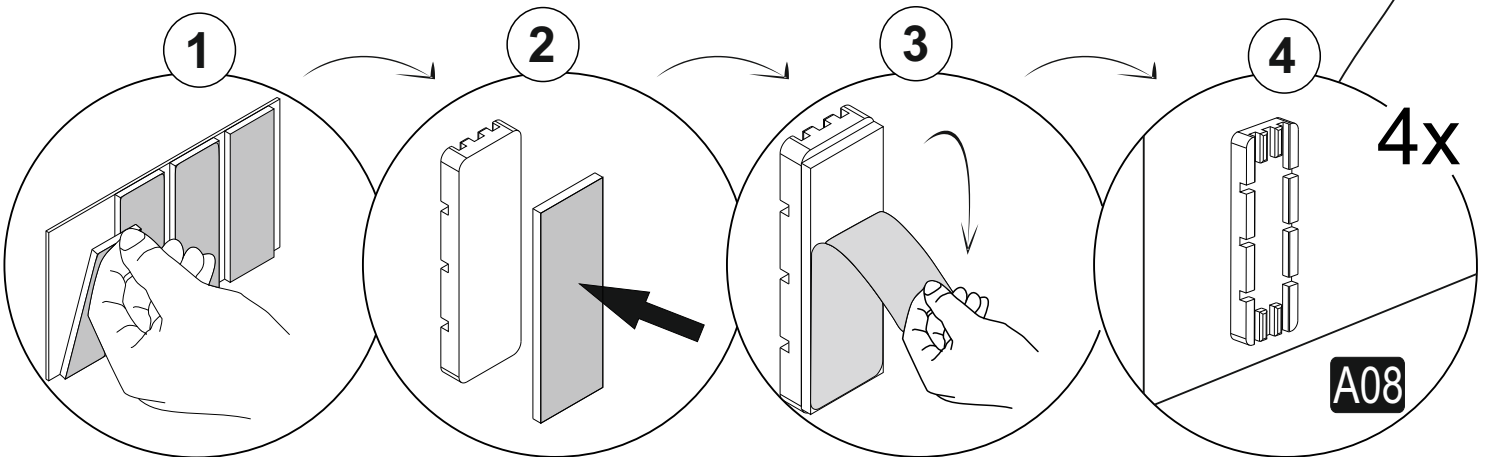
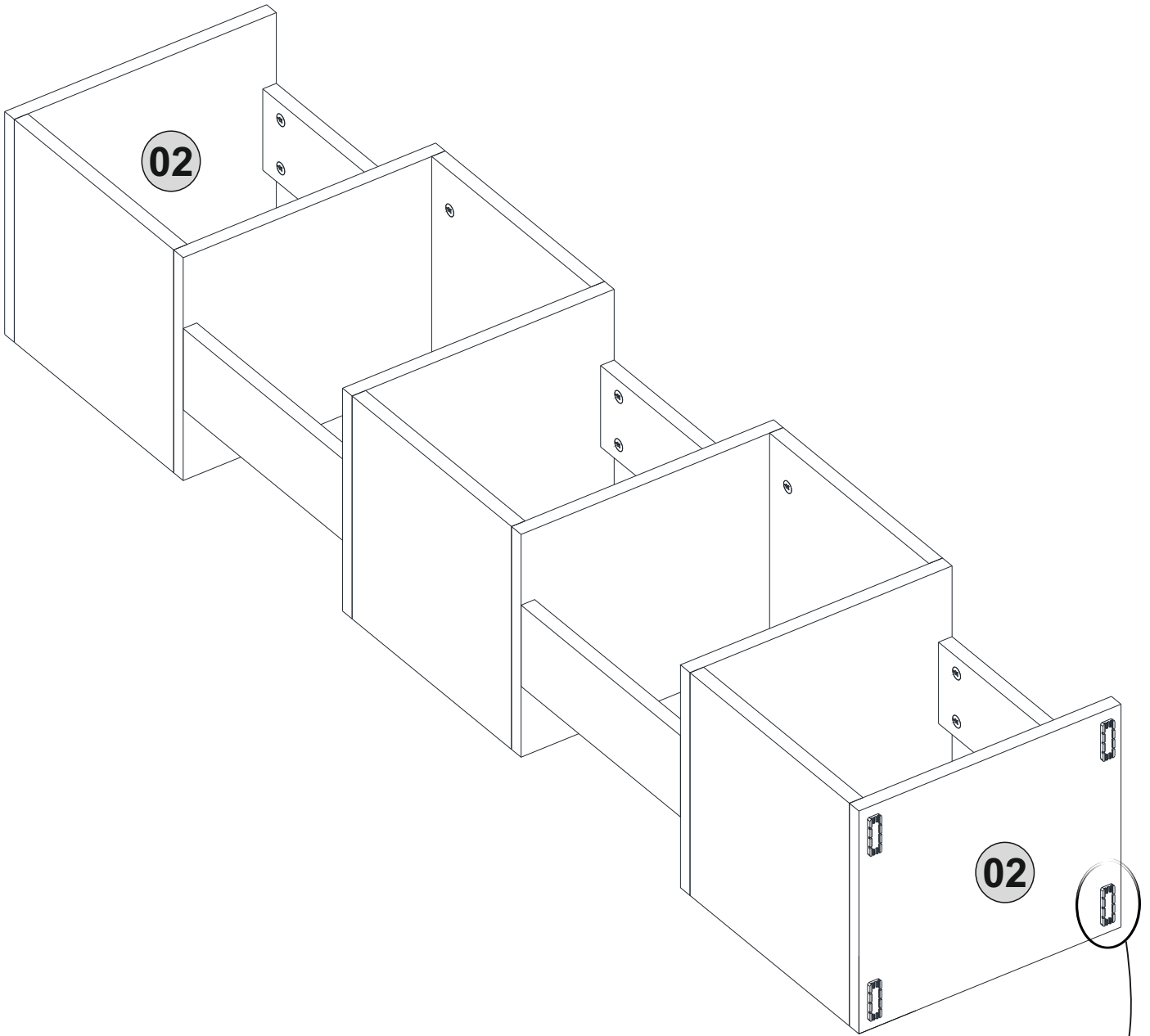

13._{step}

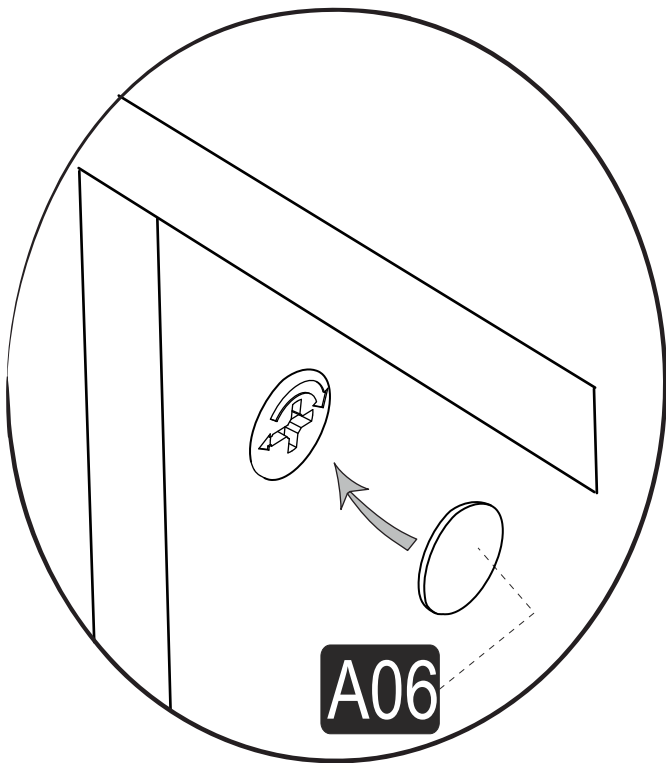
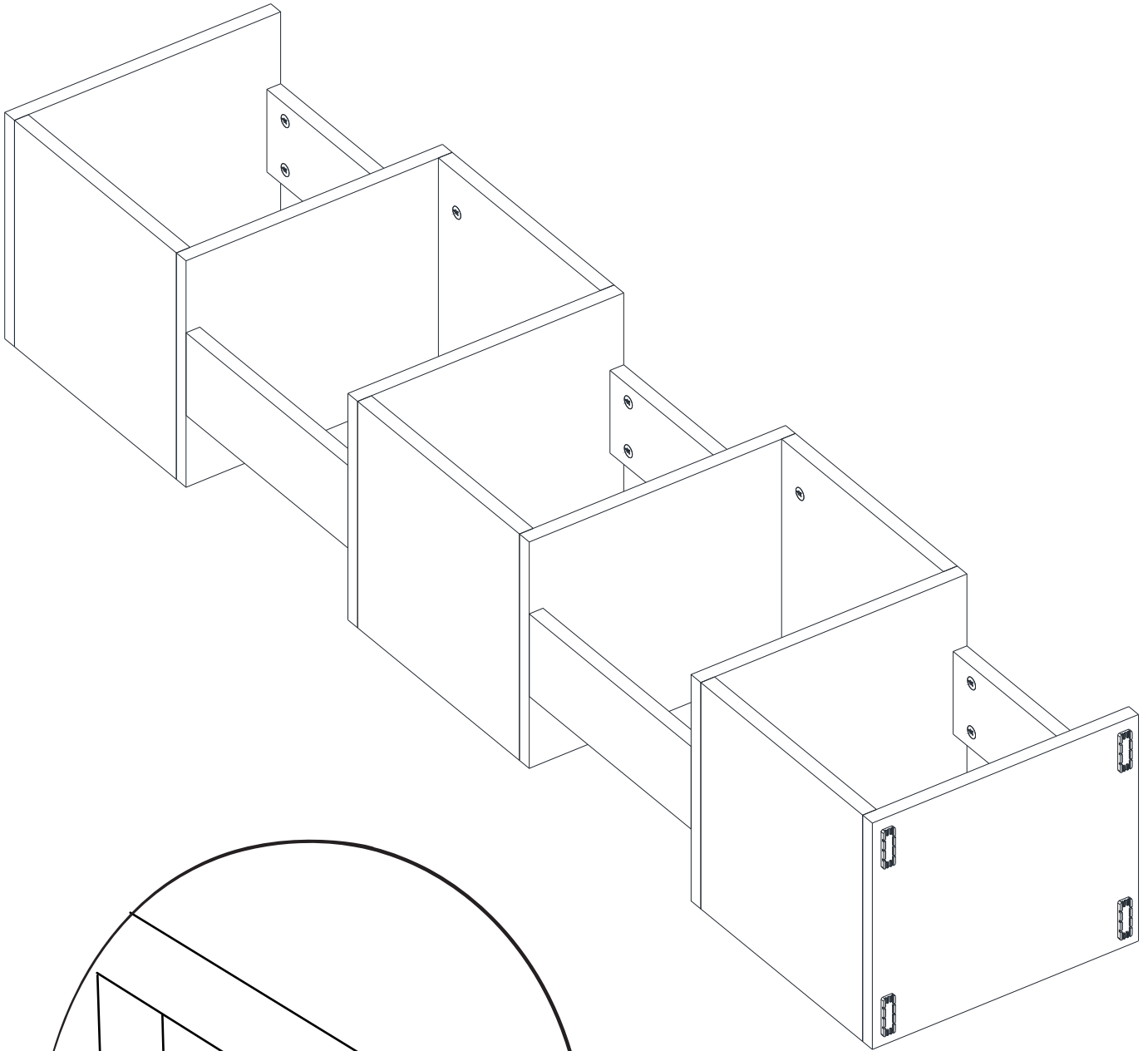

14.^{step}

