

GP037-0036,2

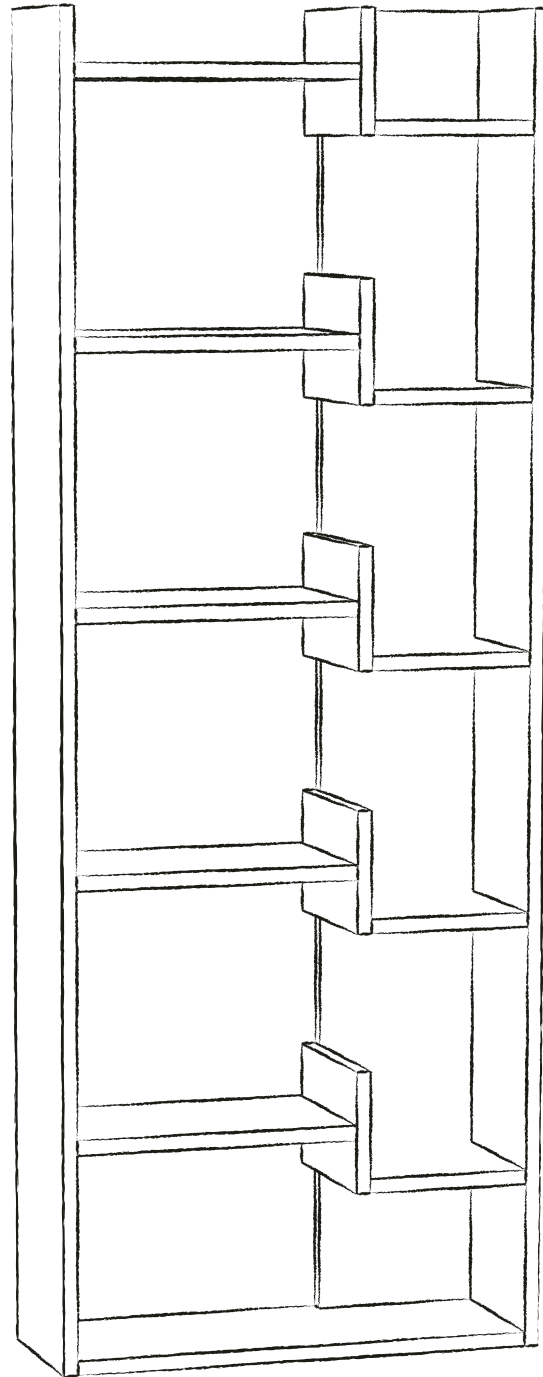

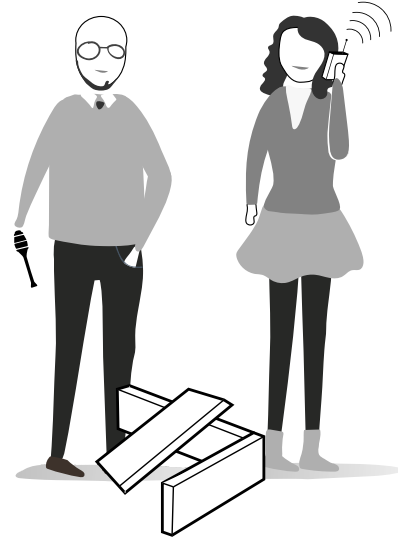
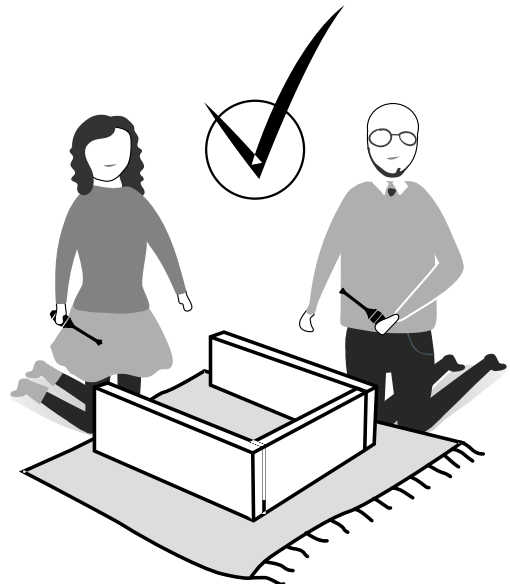
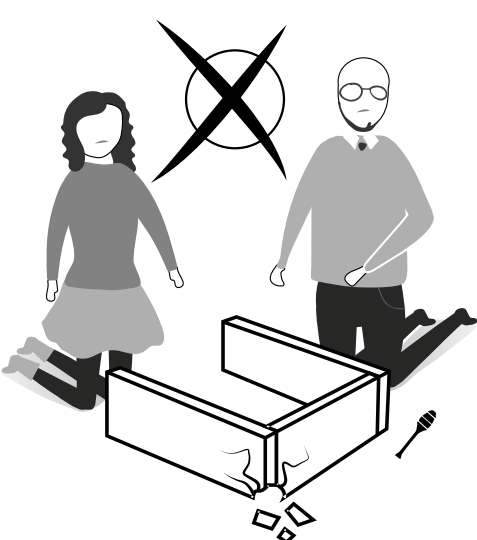
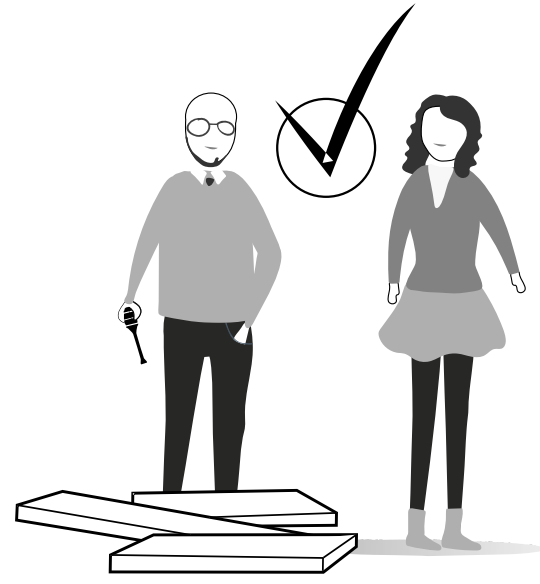
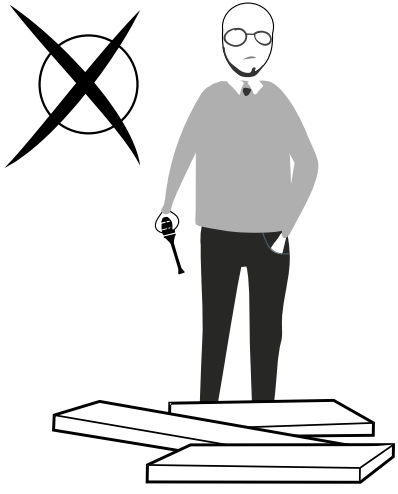

ATTENTION !!

Our products are screw system. Before you proceed with installation try to understand the following



A13



1

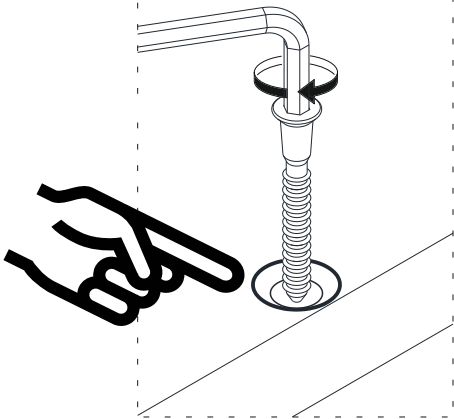

1

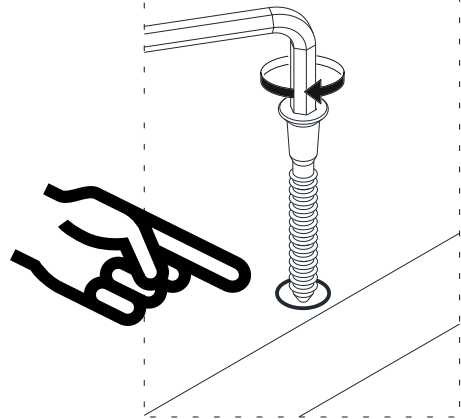

2

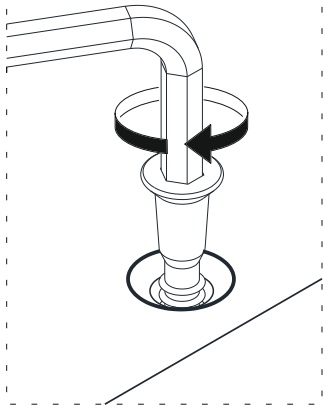

2

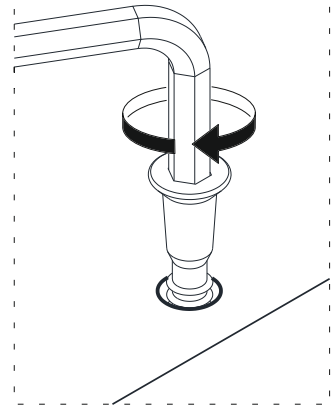

3

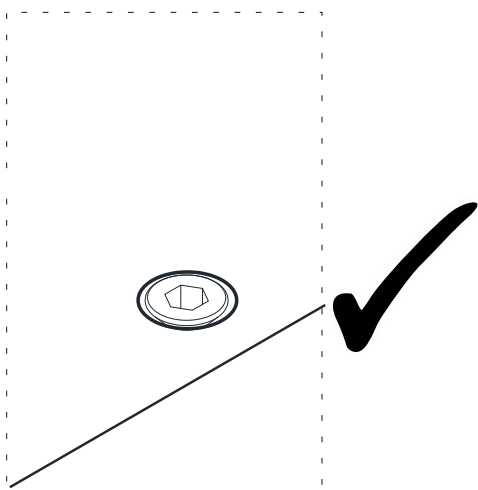



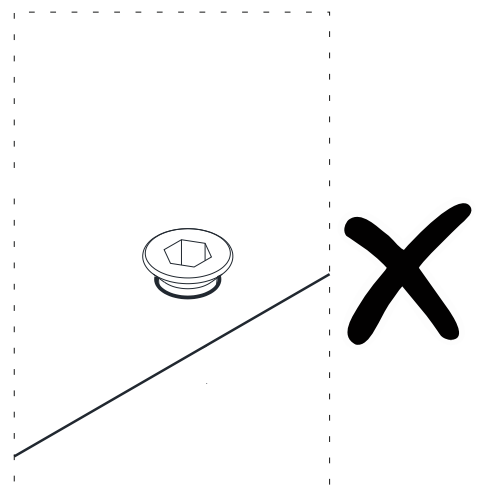

3



Follow the installation steps in the order as shown.
Position the parts as shown in the installation guide steps.

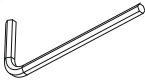
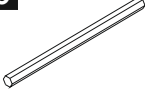

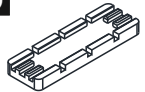
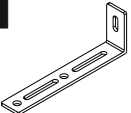
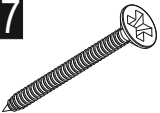
ACCESSORY LIST

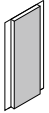
A13  50mm 52x	A12  Allen 1x	A26  Allen 1x	A06  18mm 52x	A08  5mm 4x
A87  15x90x30 1x	A17  4x50 1x	A16  DbØ8 1x	A18  3,5x18 2x	Y03  Ctpb 4x

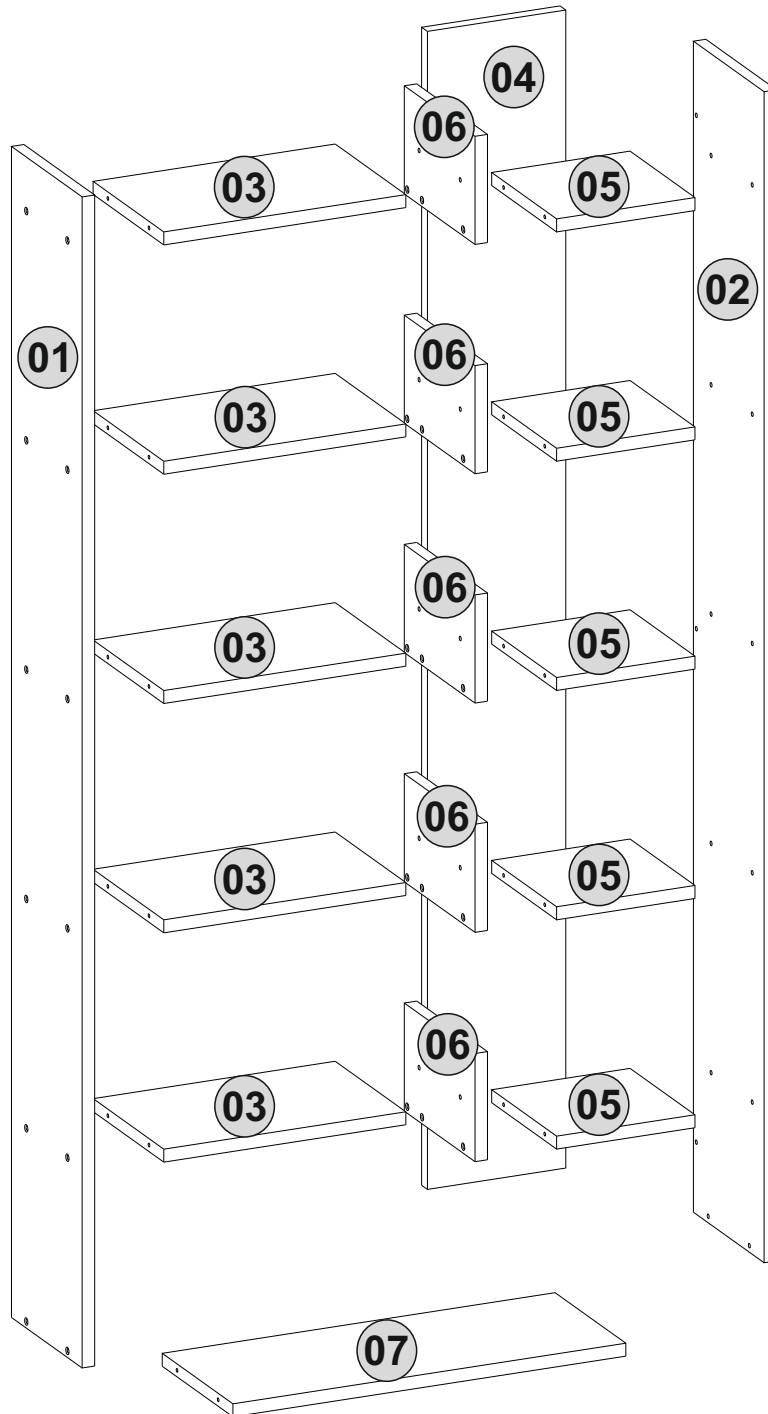

1. step

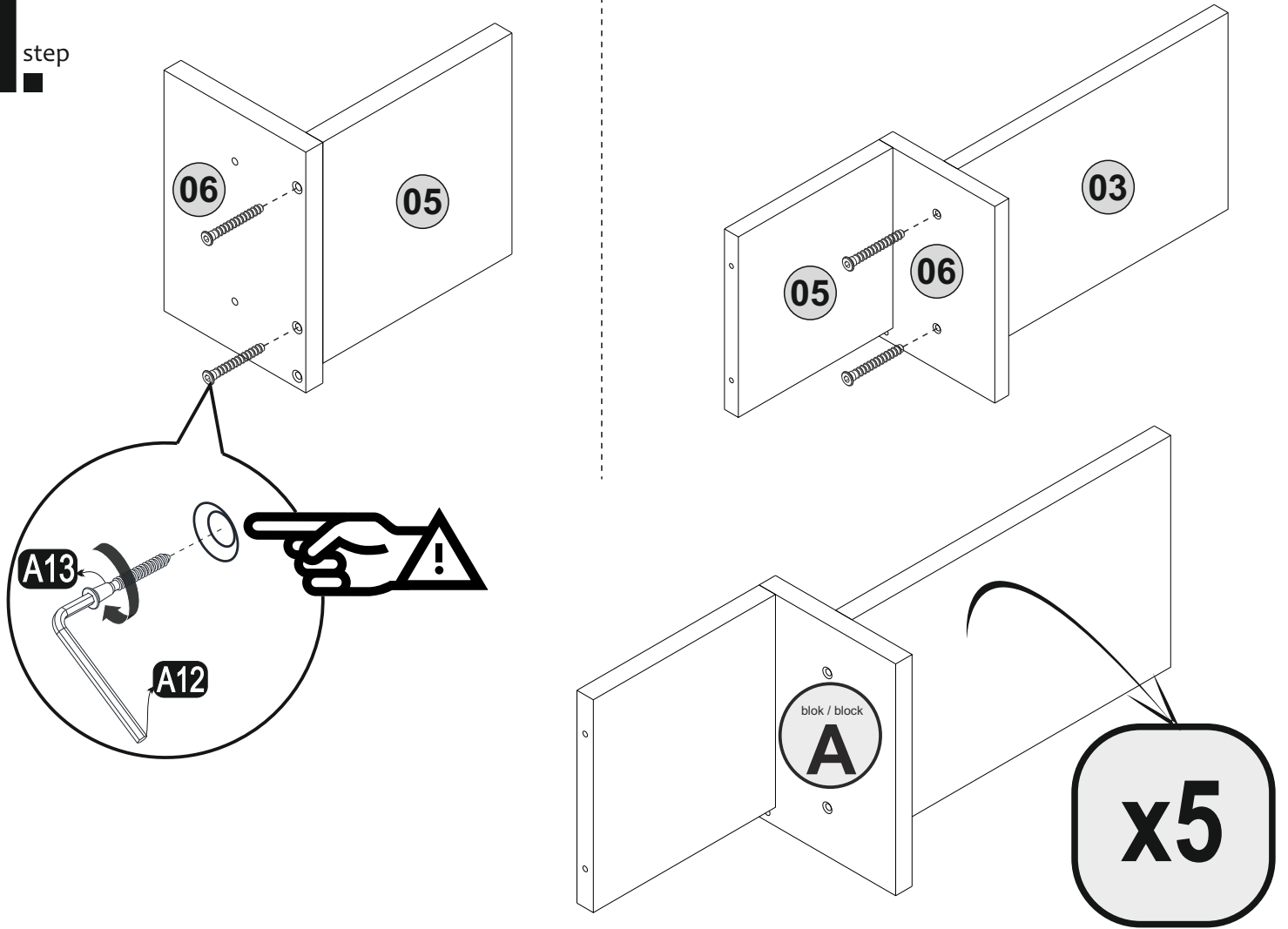

2. step

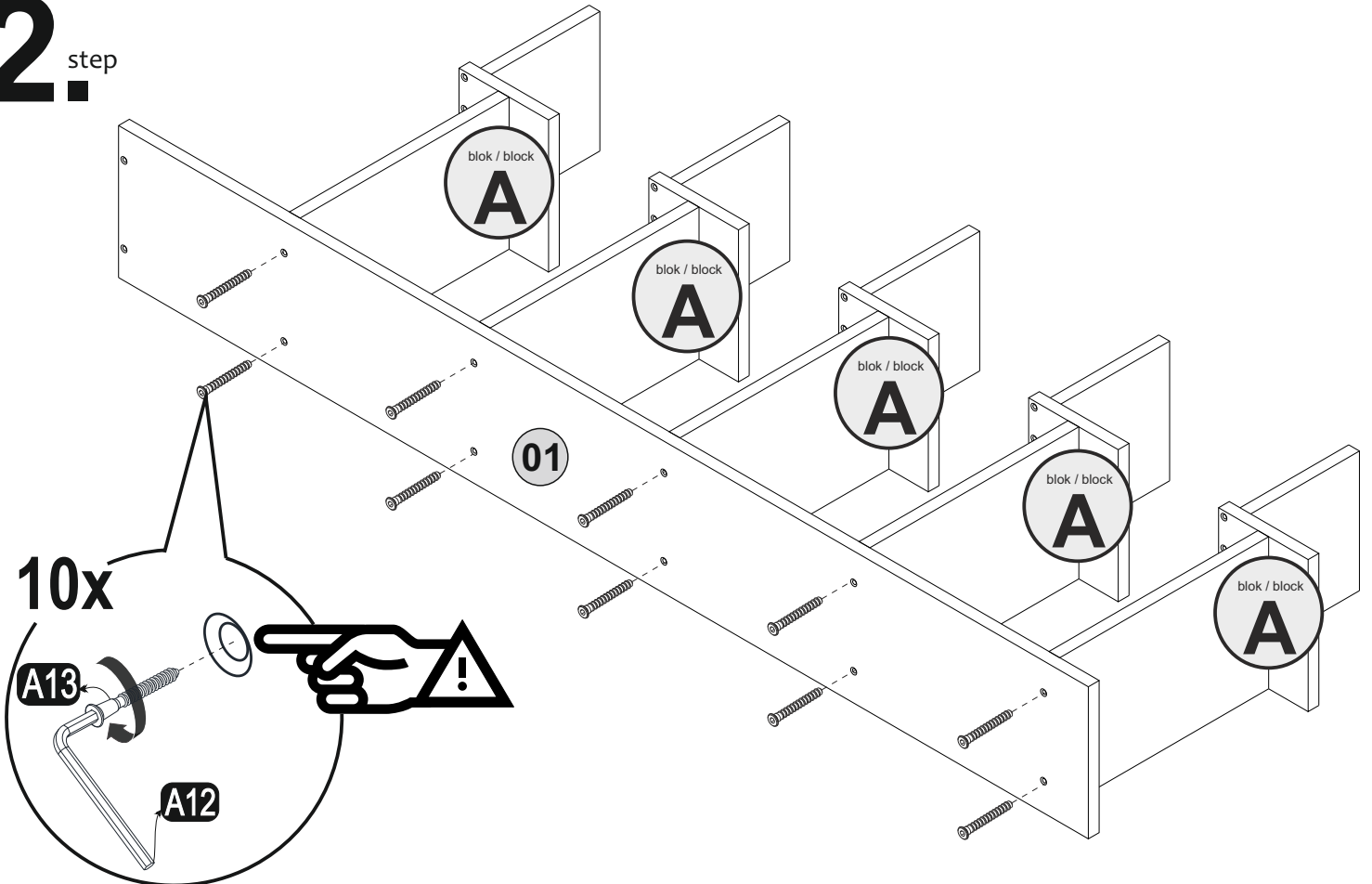

3. step

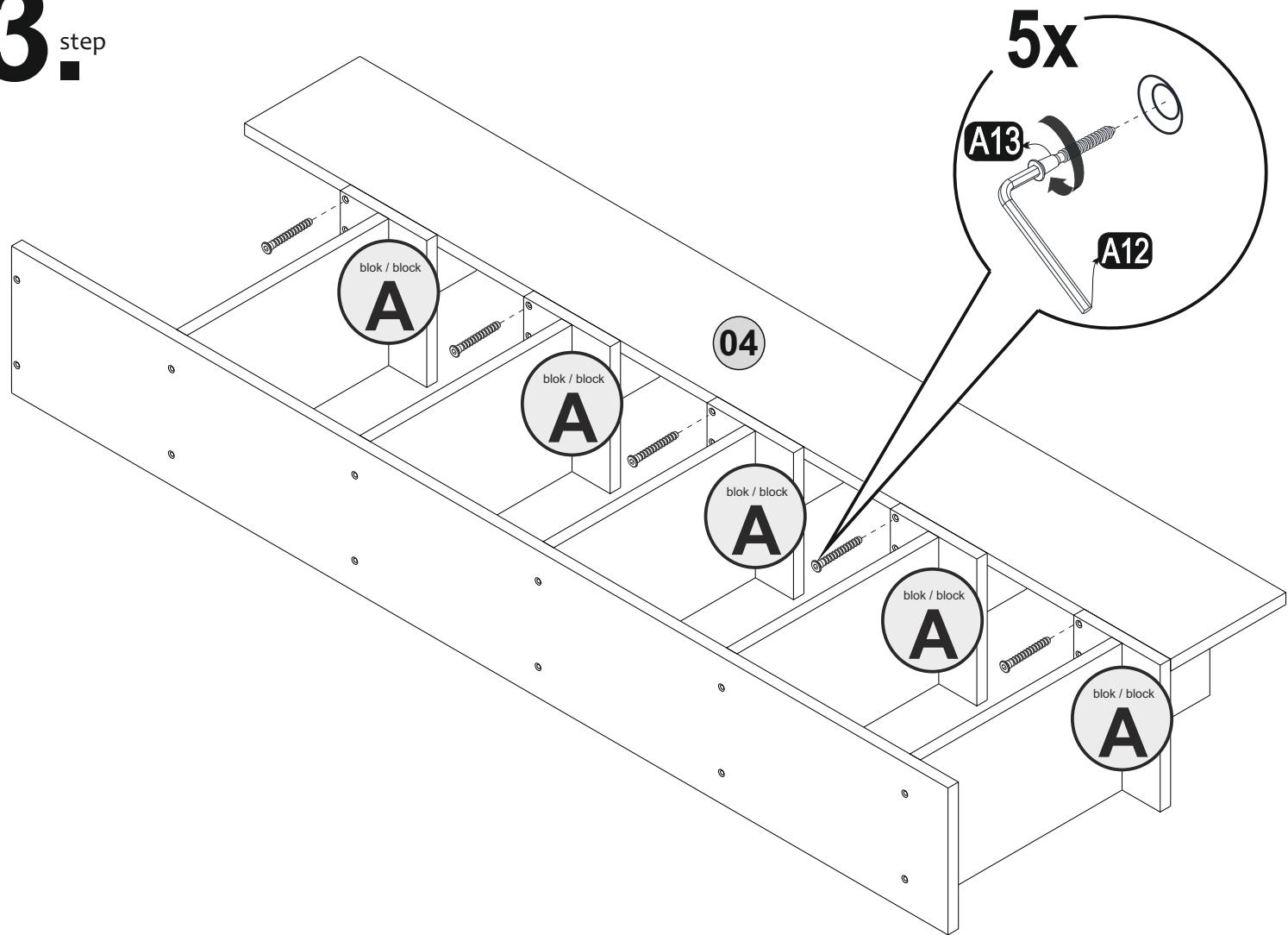

4. step

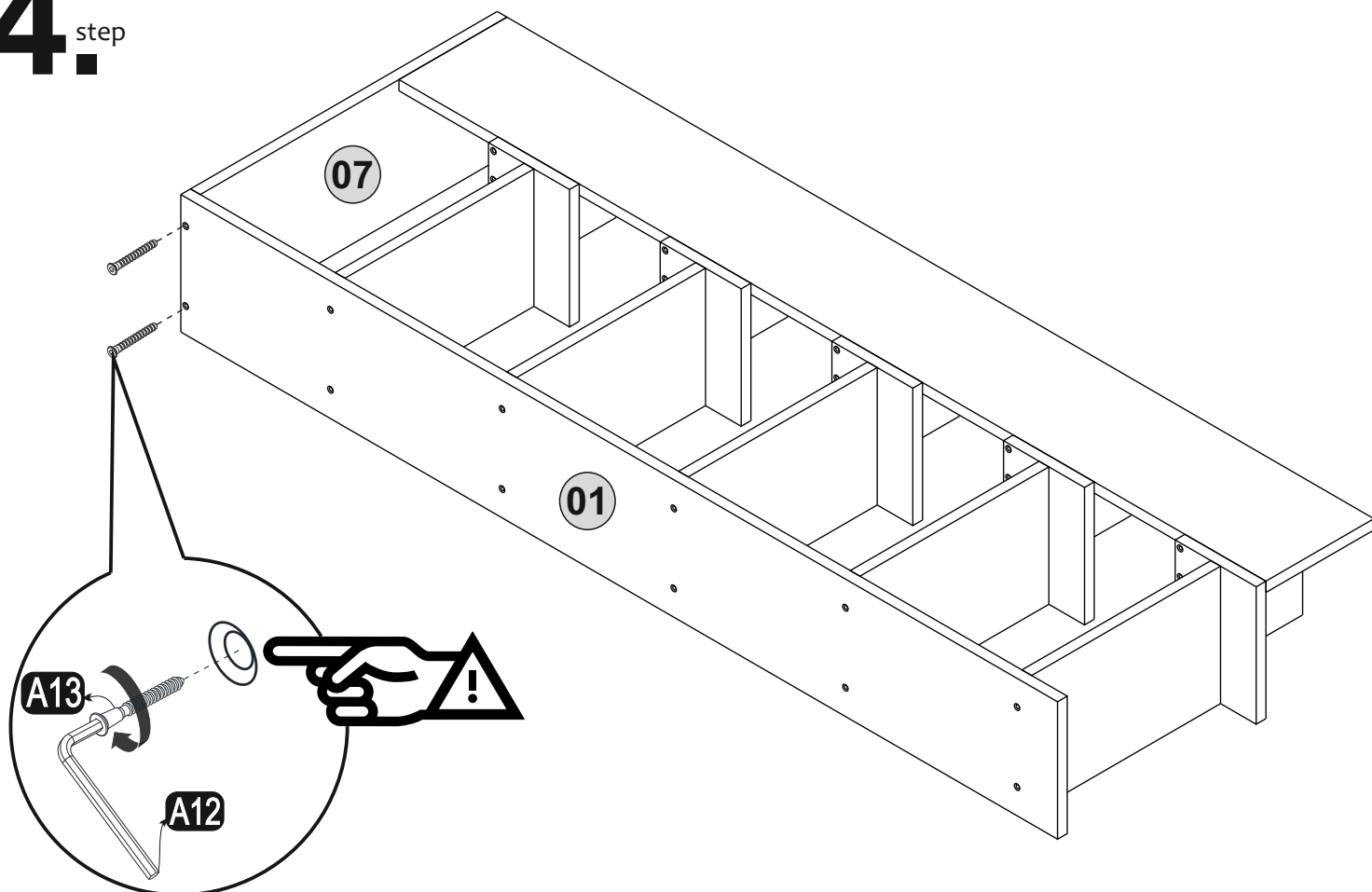

5. step

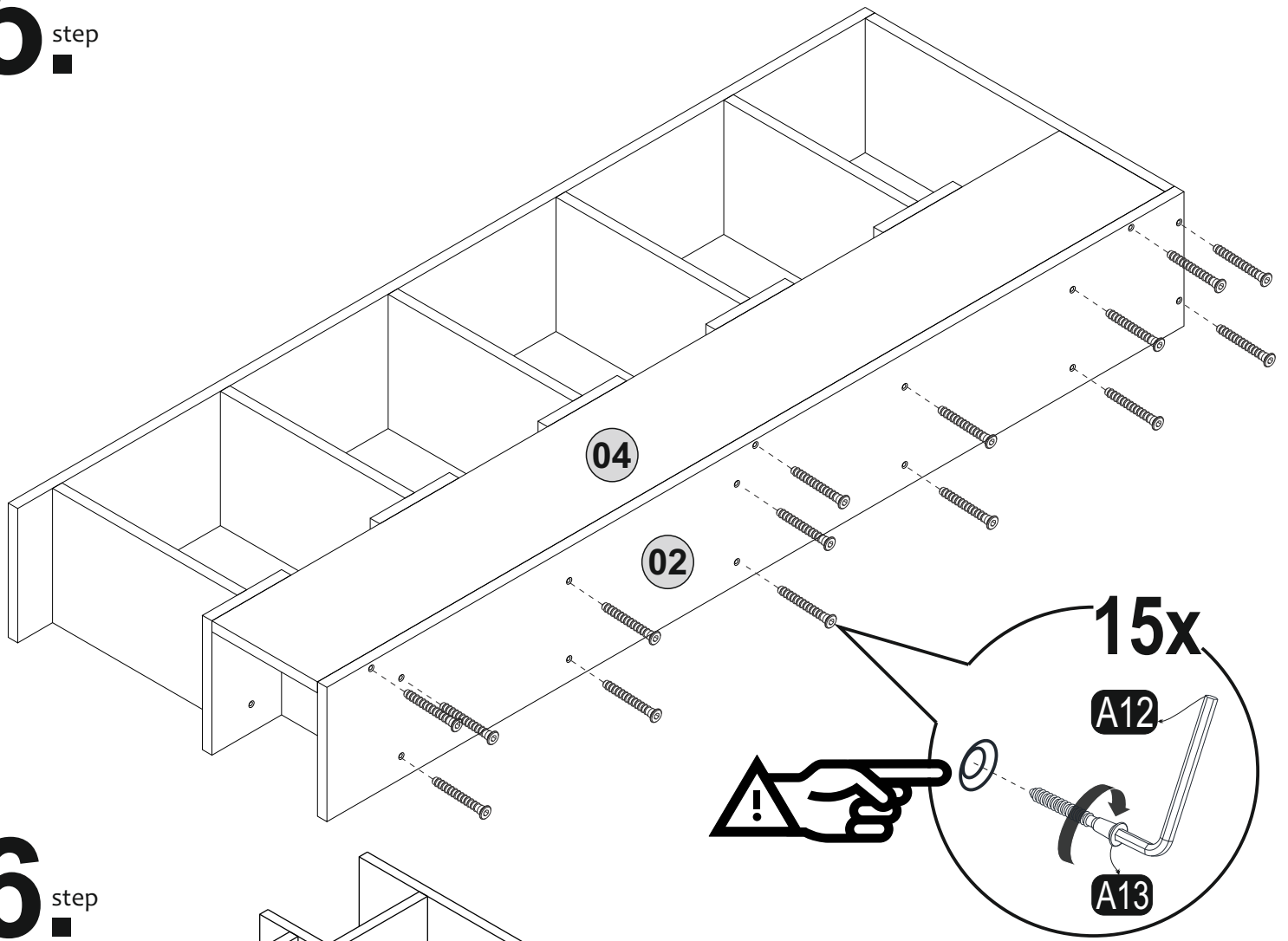

6. step

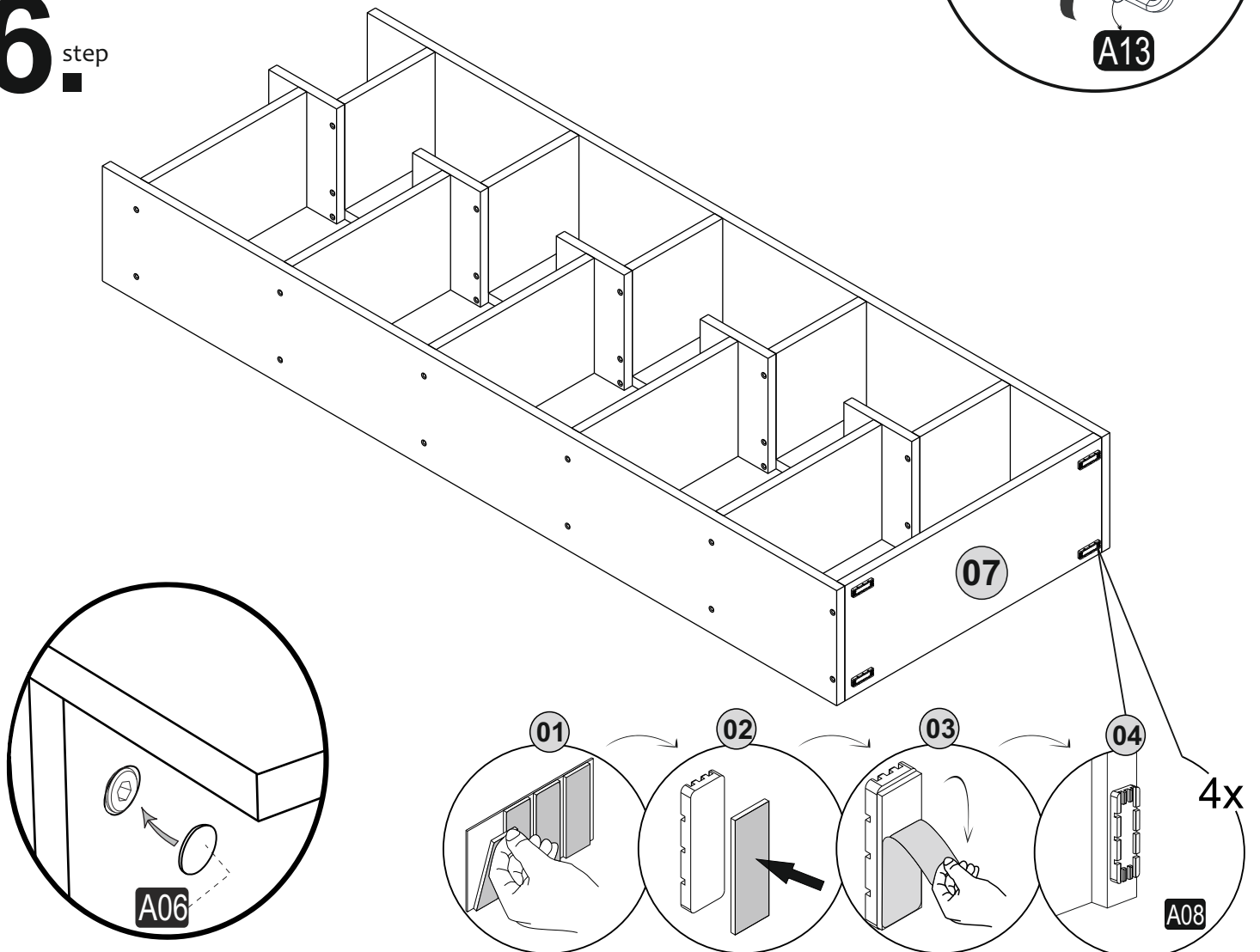

7 step

