

GP037-0016,3

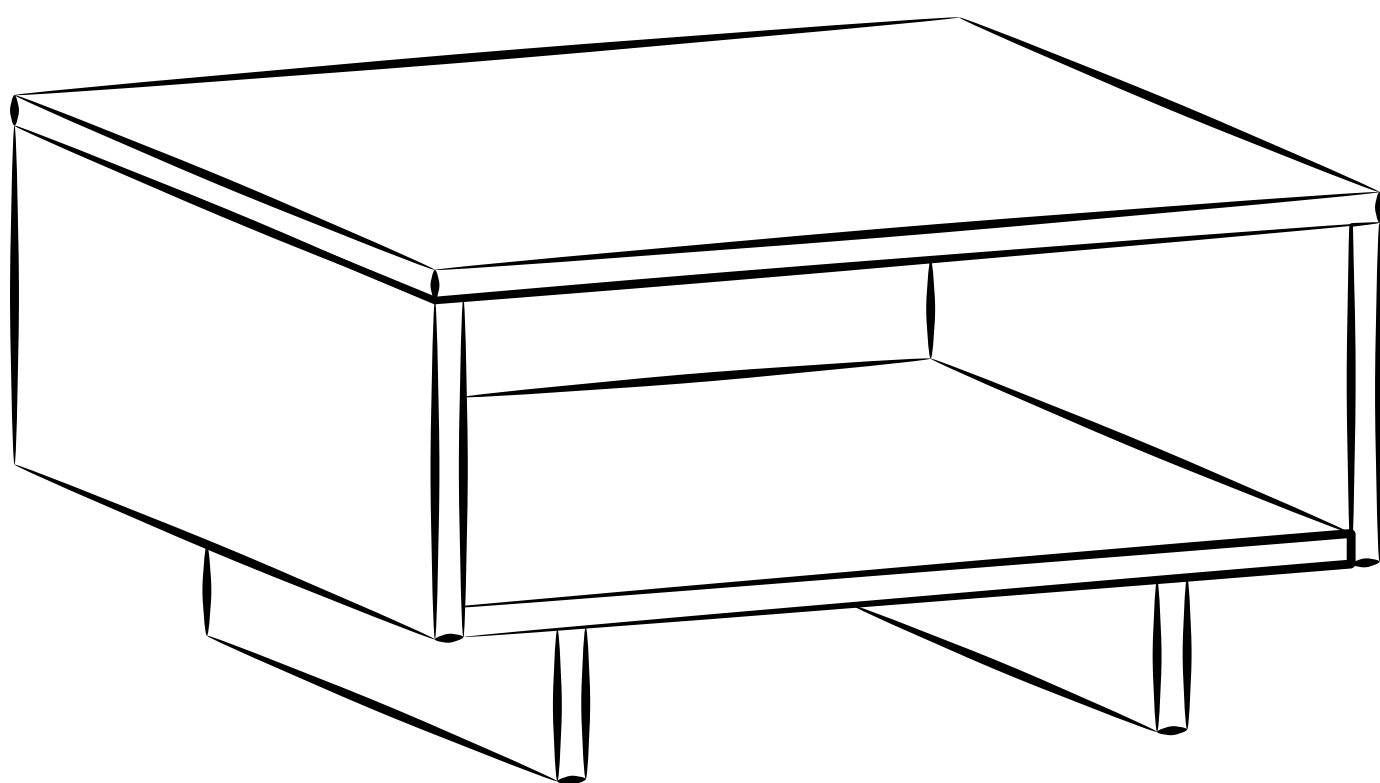

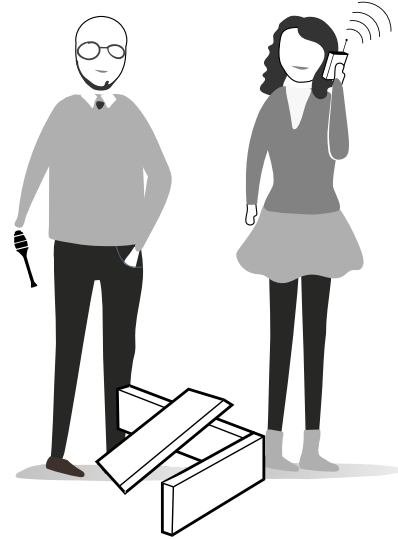
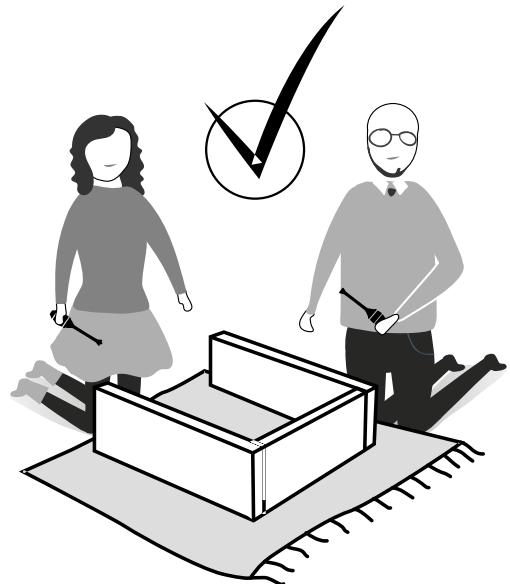
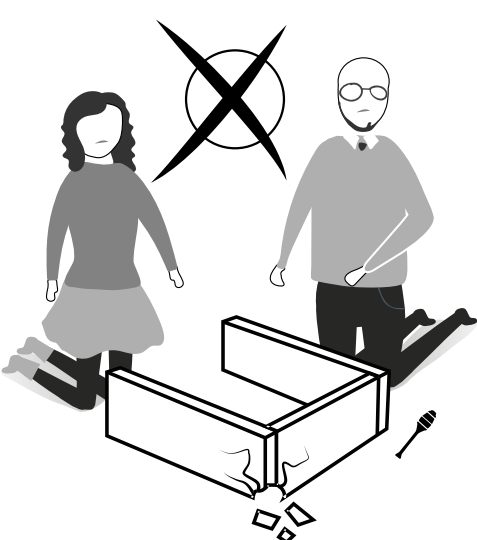
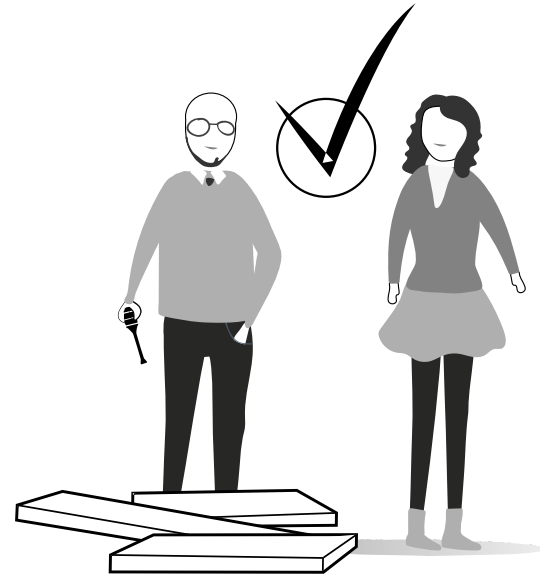
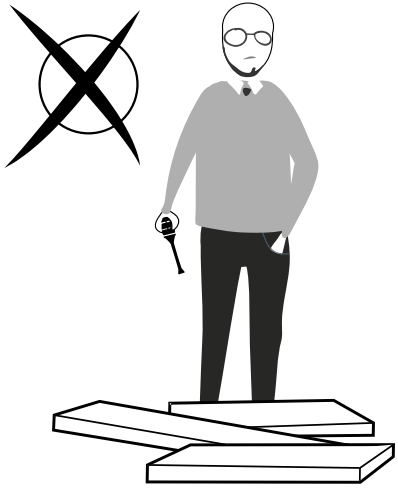

ATTENTION !!

Minifix is the main connection material used in ada products.
Before starting assembly, please check the drawings below.

A04

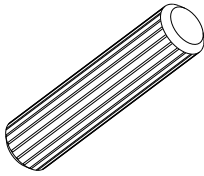

A23

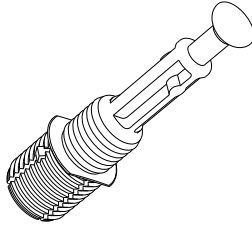

A22

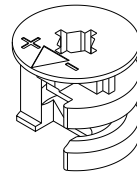

1

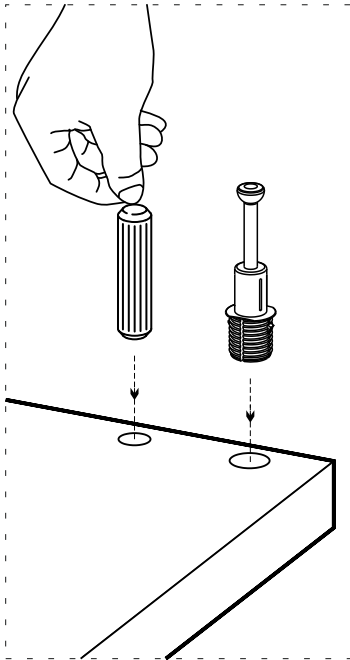

2

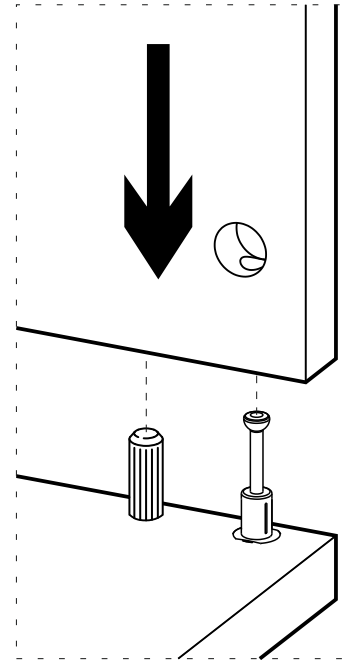

3

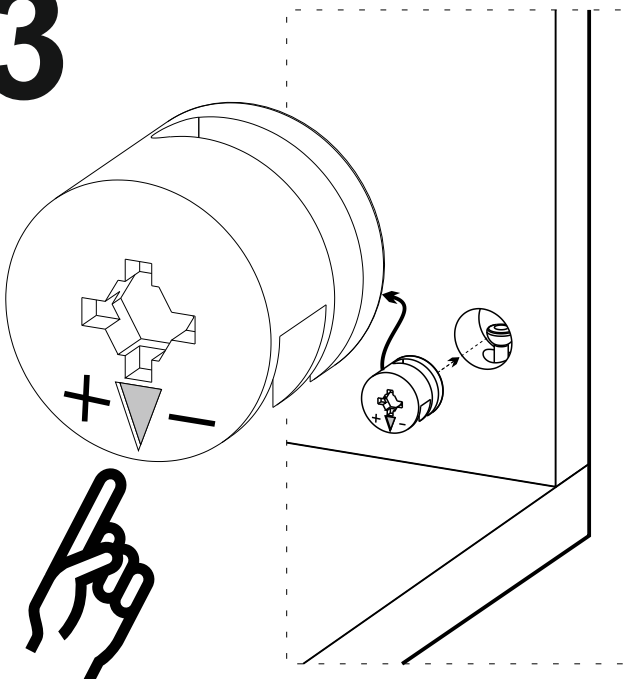



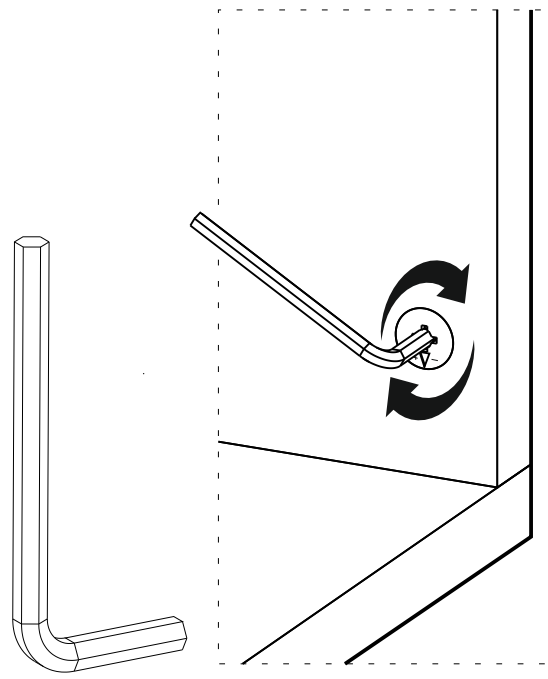

4



Follow the installation steps in the order as shown.
Position the parts as shown in the installation guide steps.

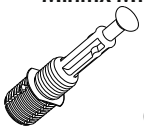
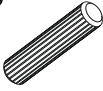
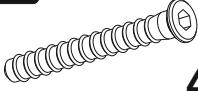

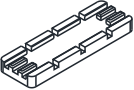
ACCESSORY LIST

A22 Minifix k18  8x	A23 Minifix M10  8x	A04 Ø8  8x	A13 50mm  4x	A12  1x
A08 c 2  4x	A06 18 mm c 1  12x			

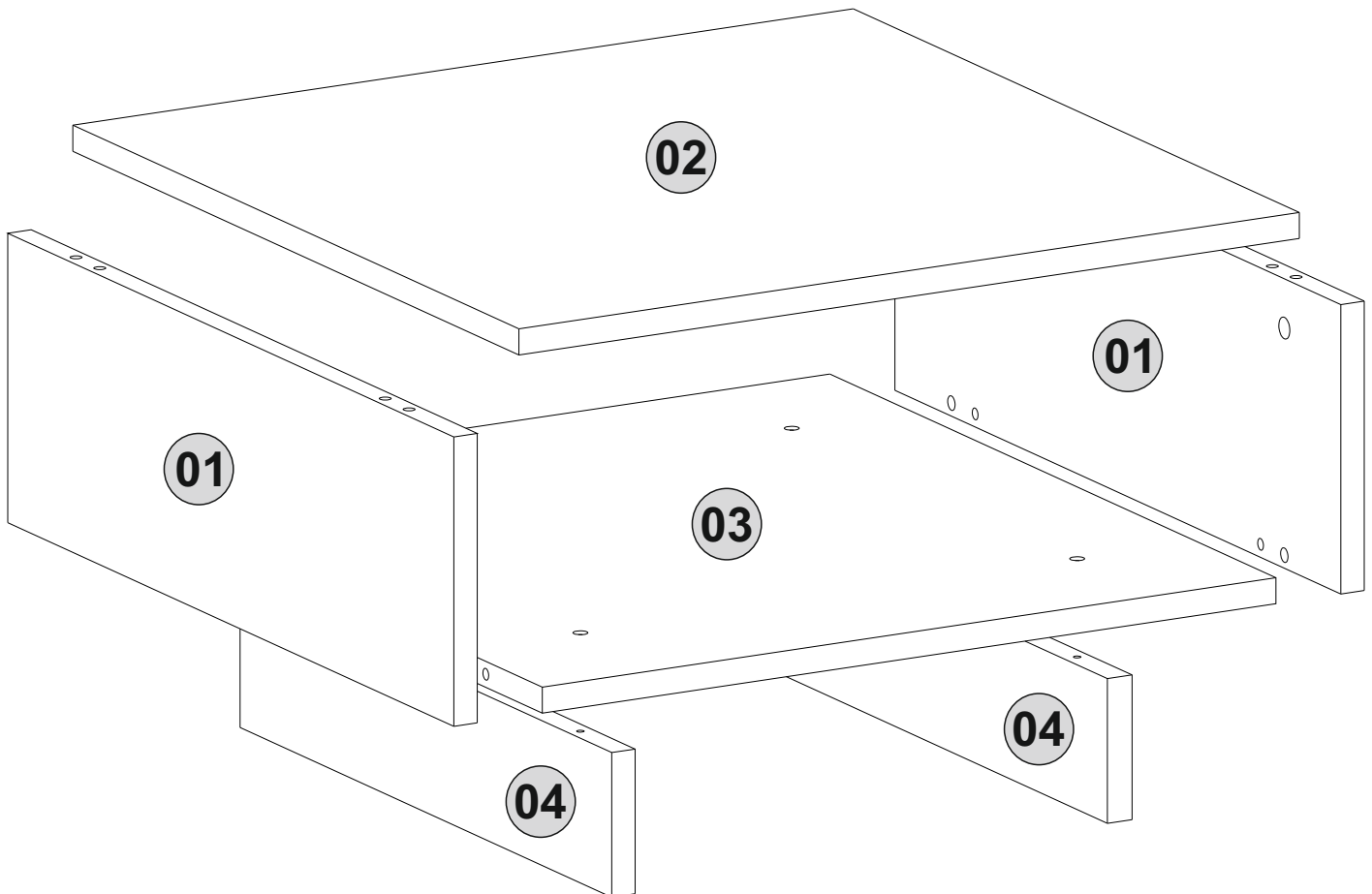

1. step

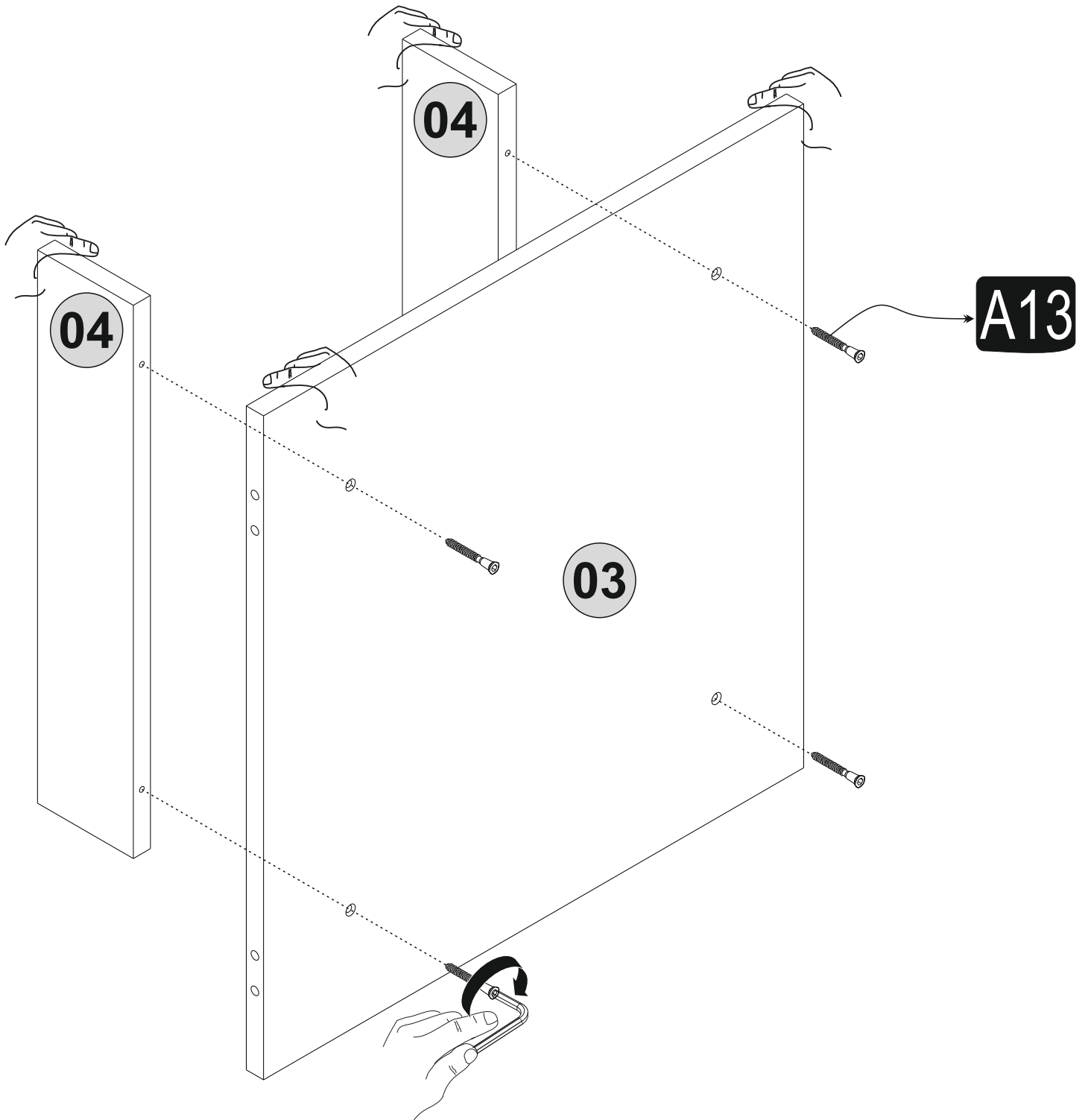

2^{step}

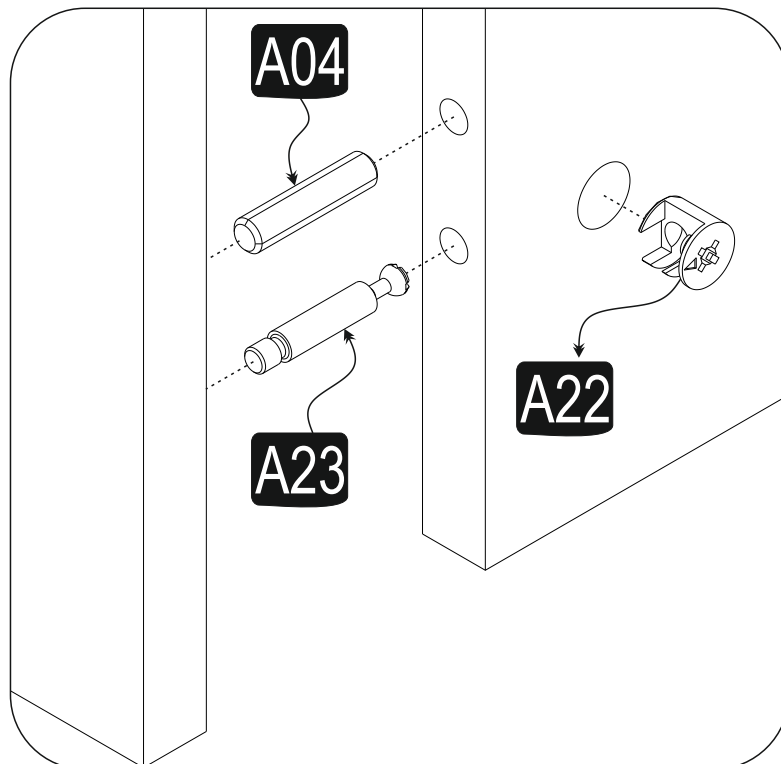
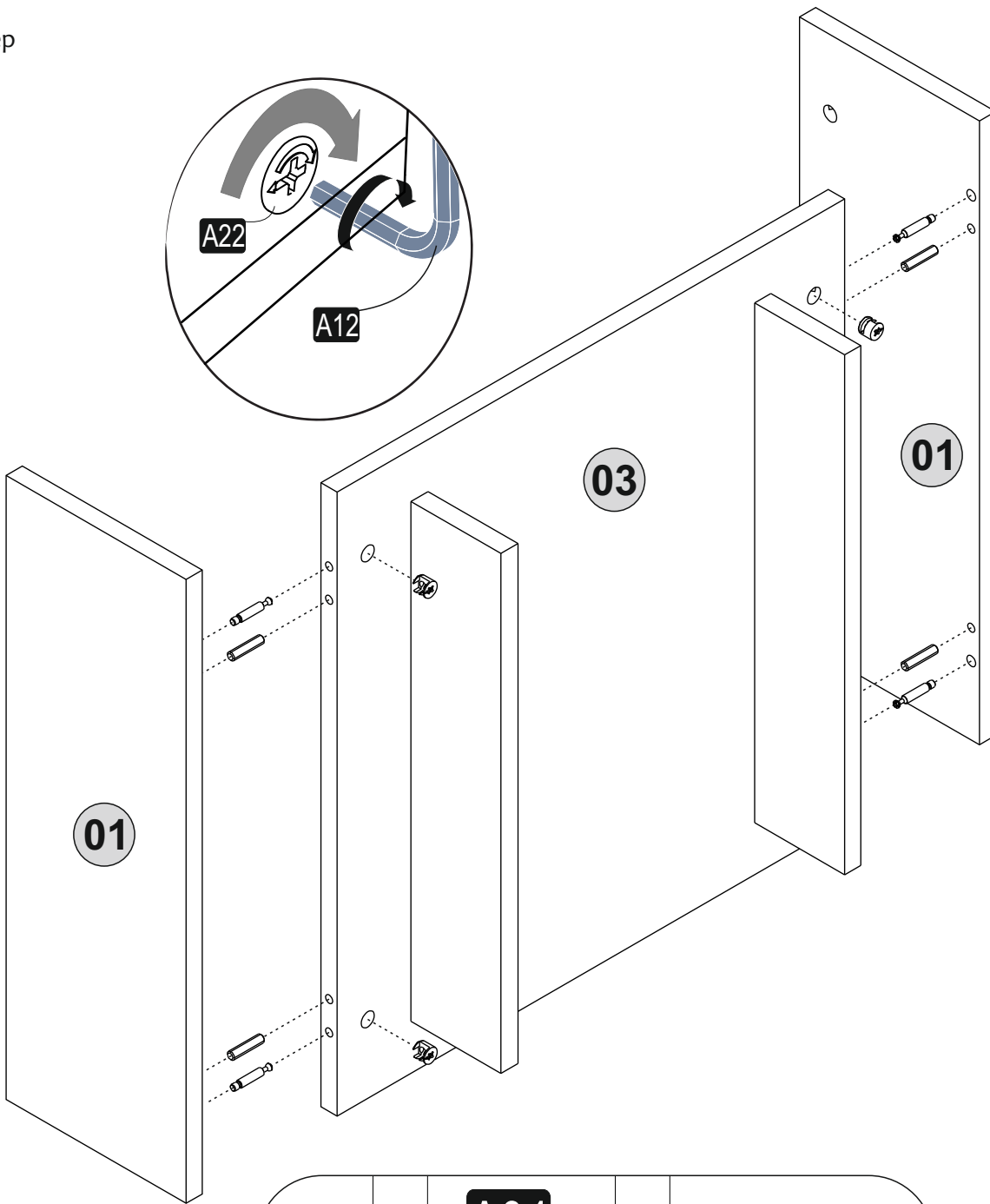

3^{step}

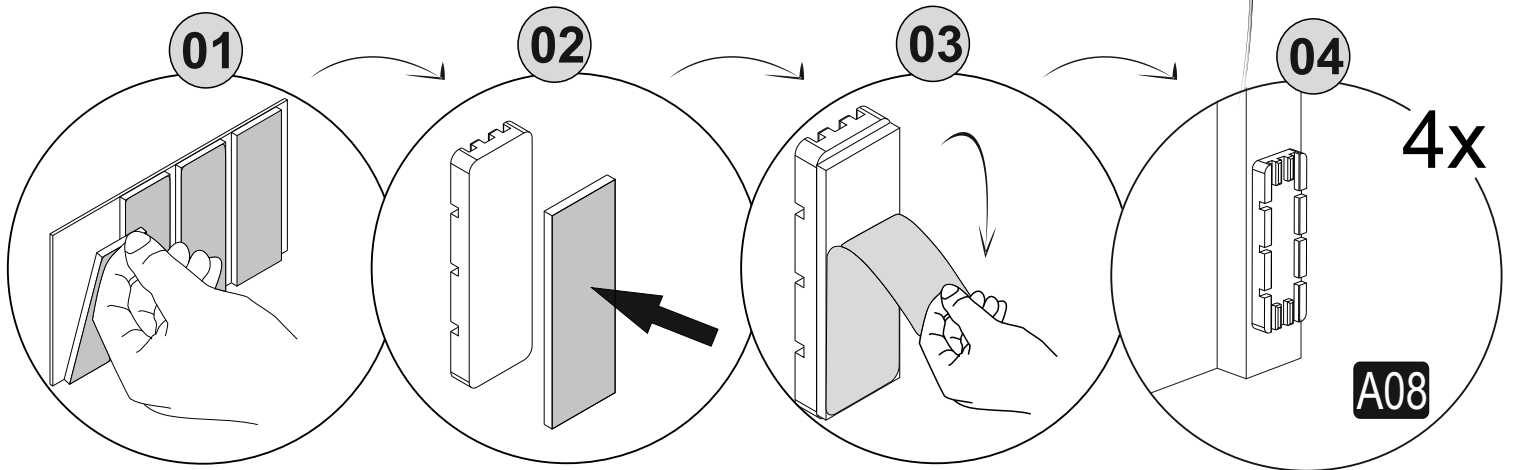
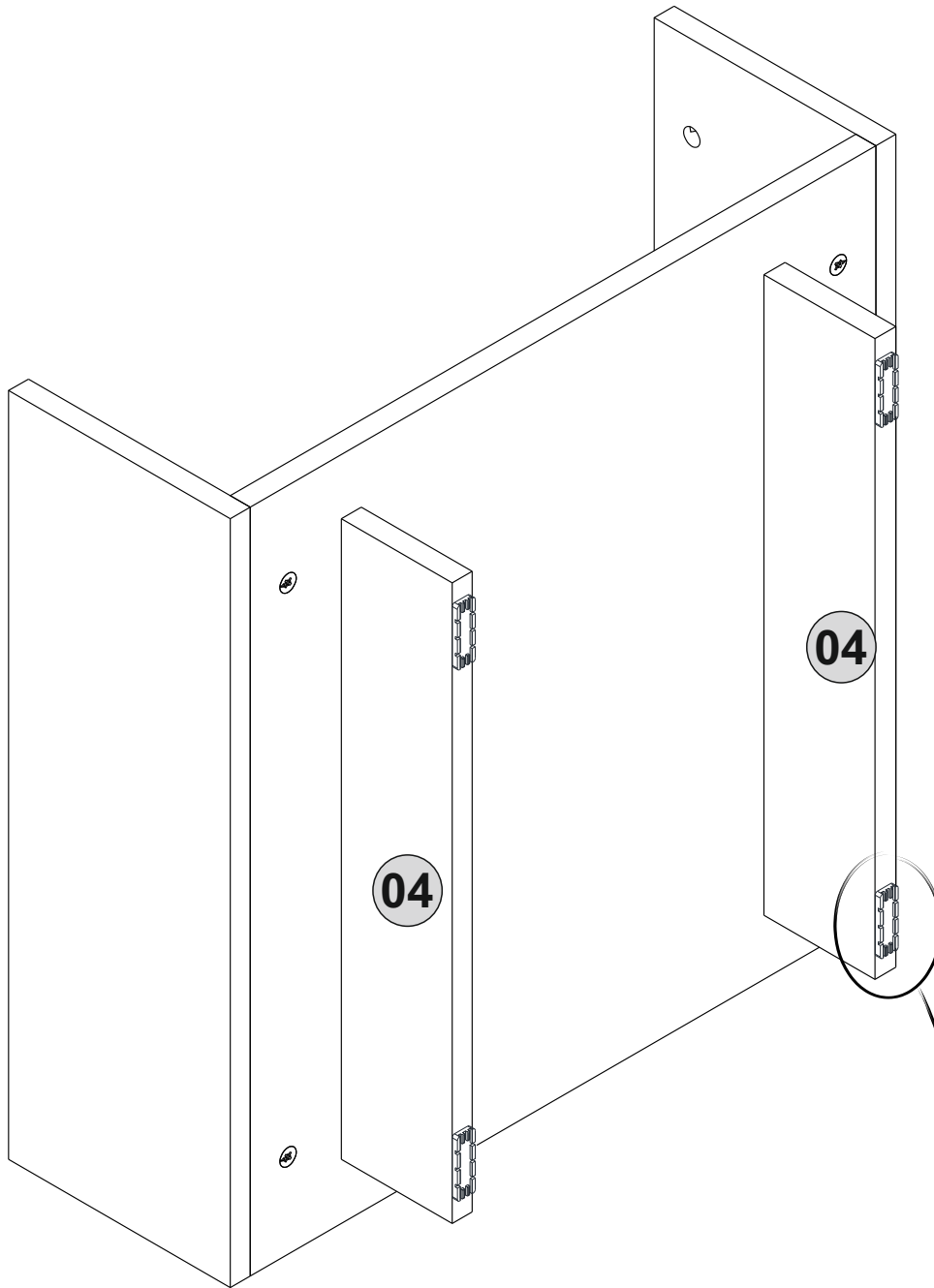

4^{step}

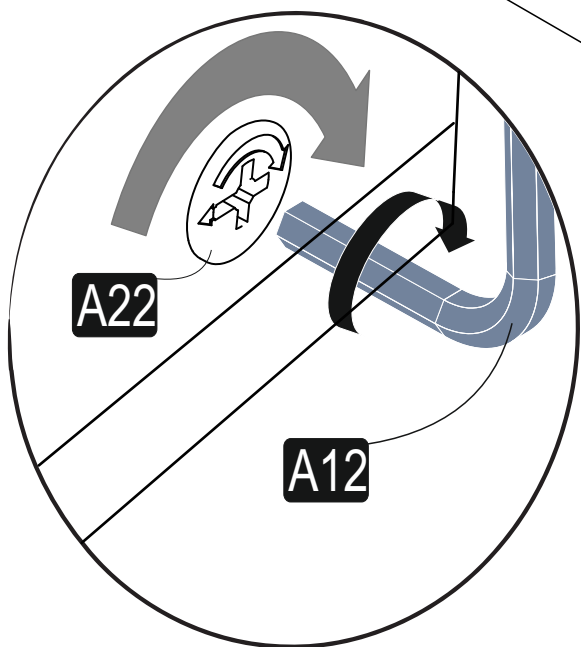
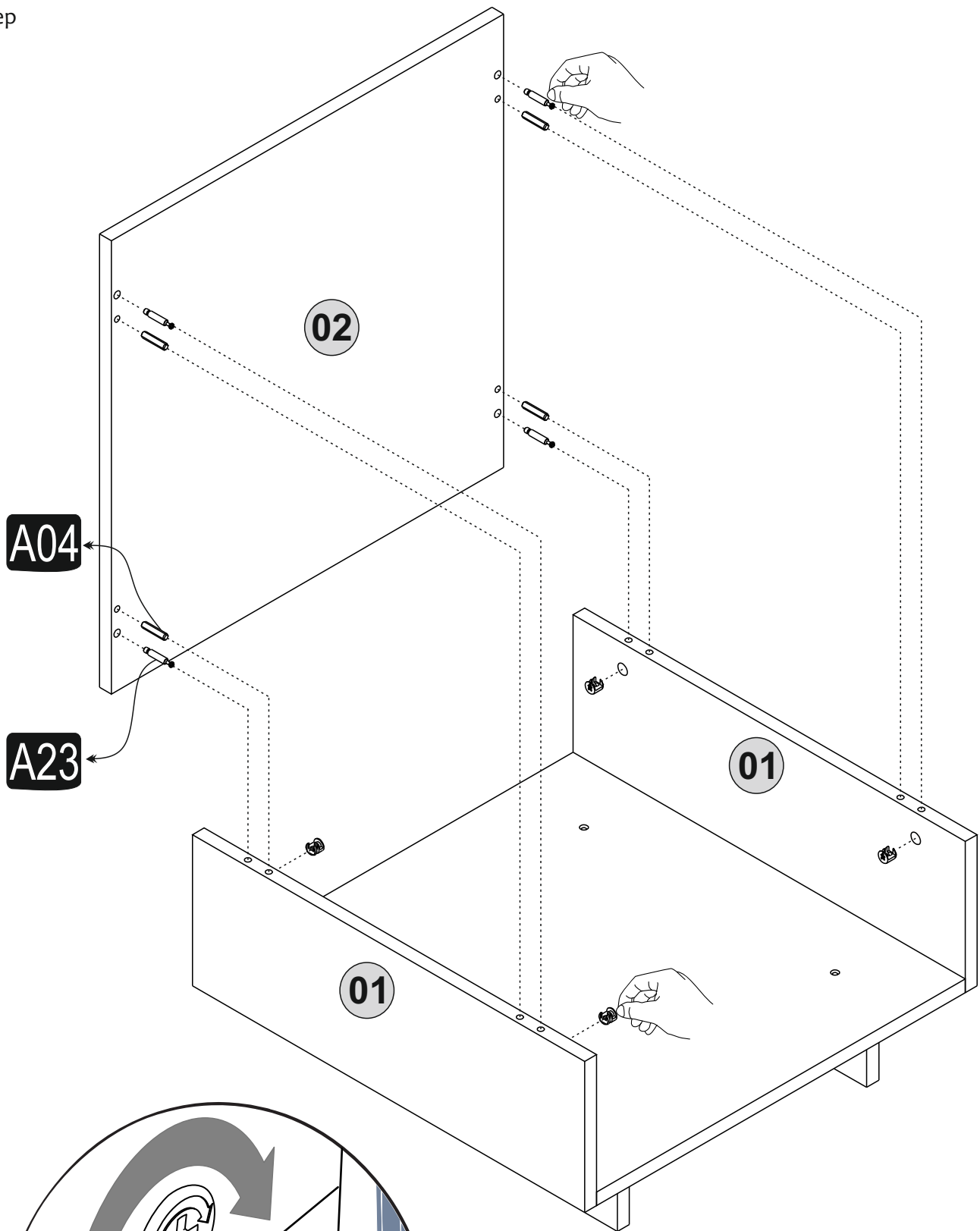

5 step

