

GP037-0005,2

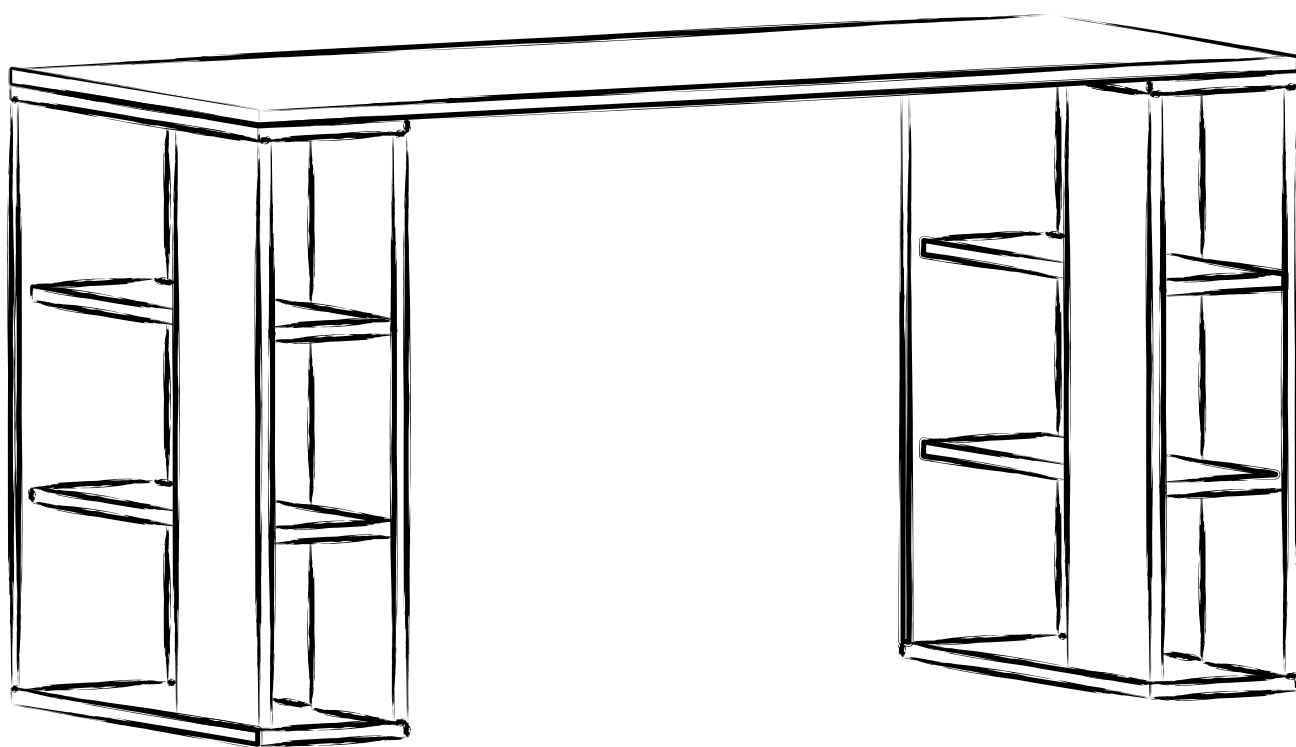

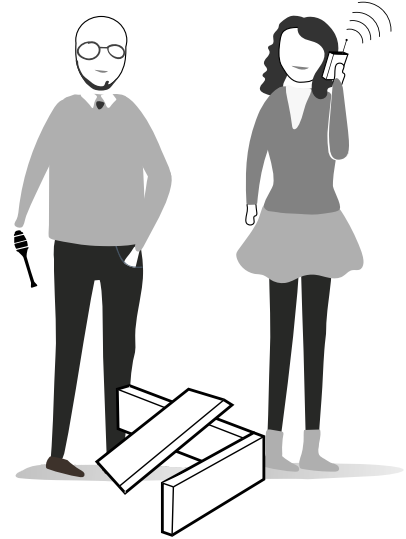
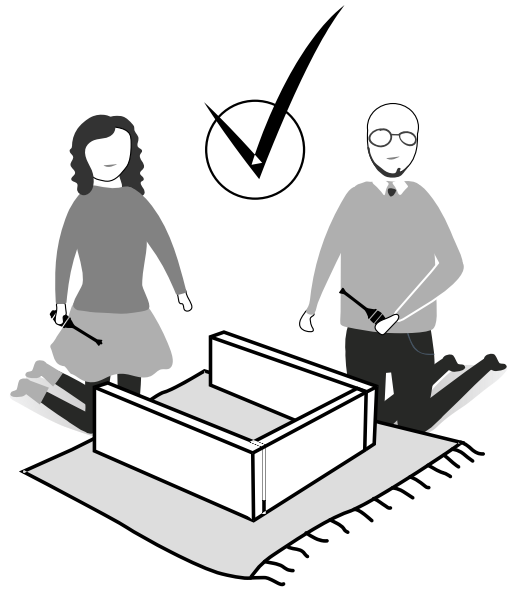
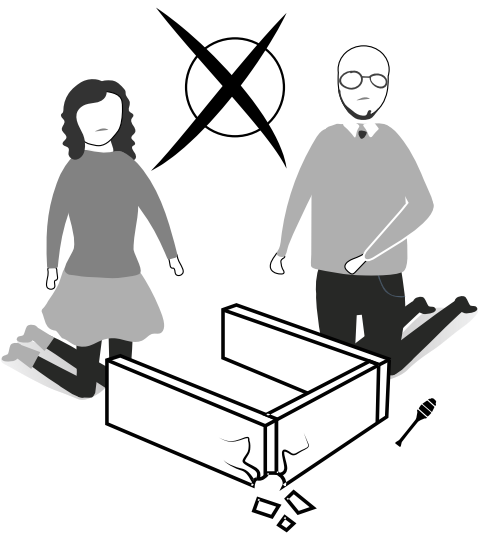
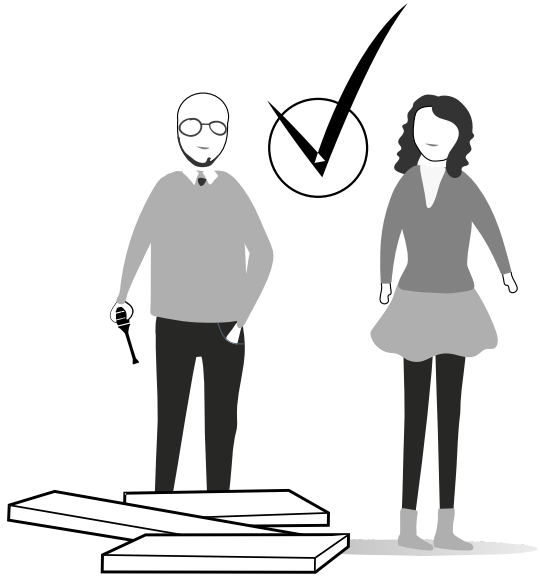
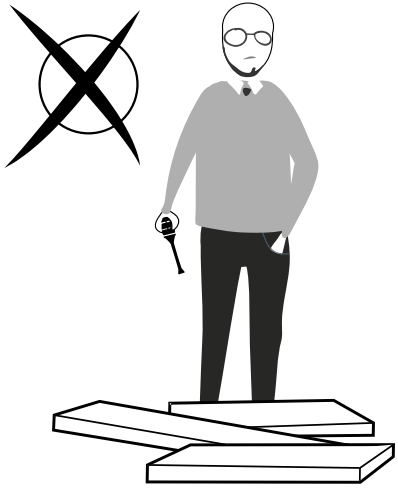

ATTENTION !!

Minifix is the main connection material used in ada products.
Before starting assembly, please check the drawings below.

A04

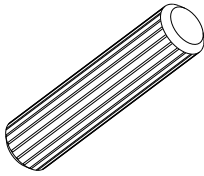

A23

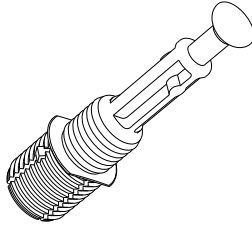

A22

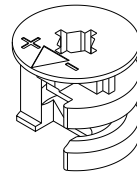

1

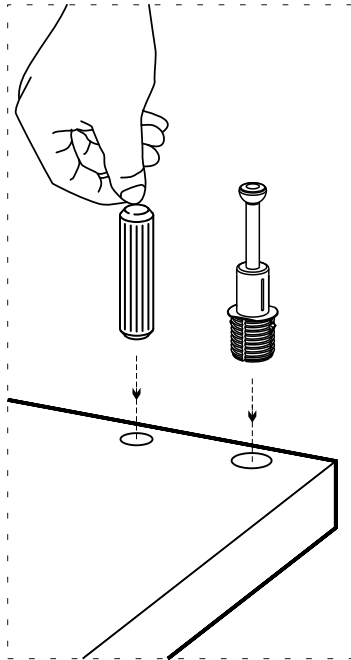

2

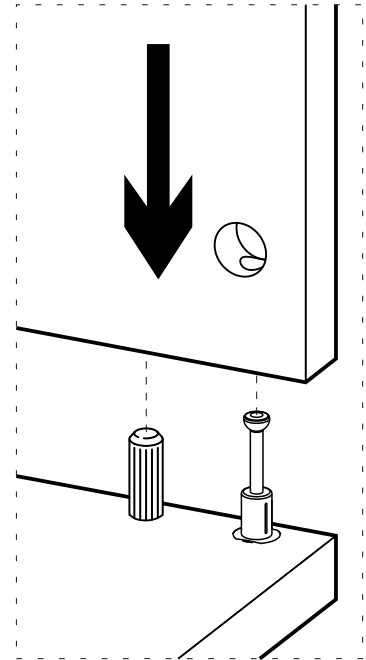

3

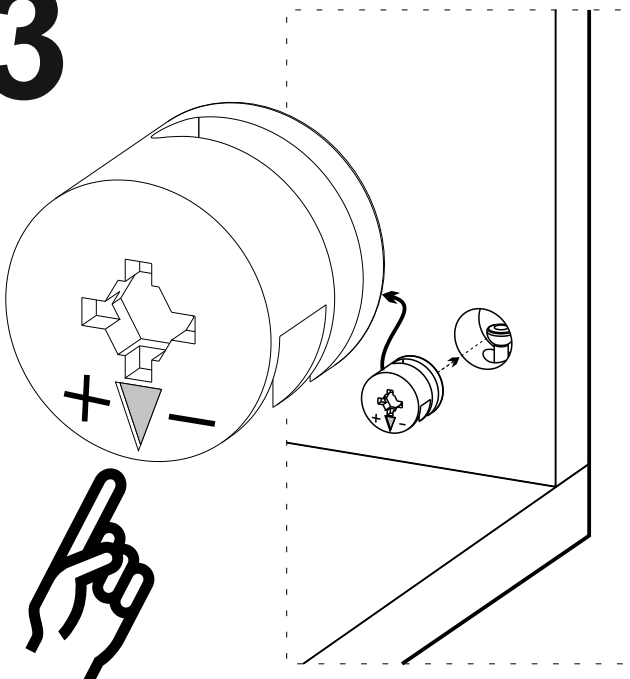

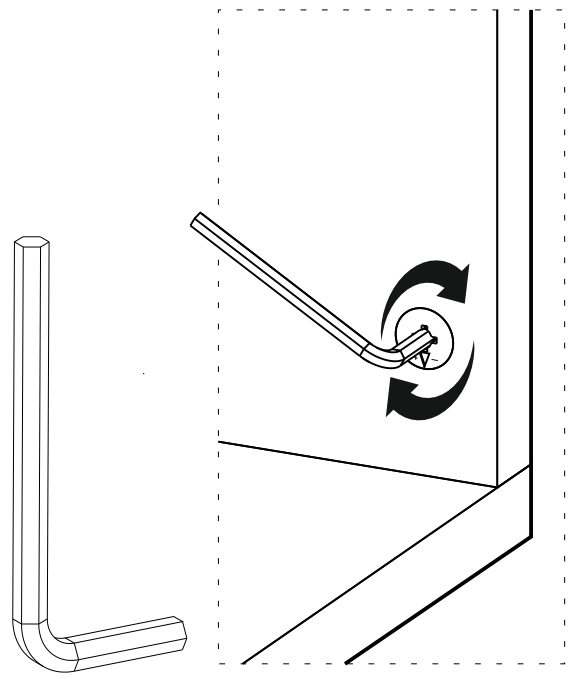

4



Follow the installation steps in the order as shown.
Position the parts as shown in the installation guide steps.

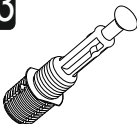
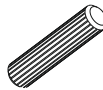
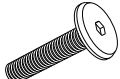
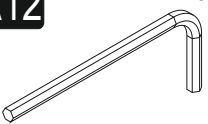
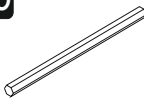
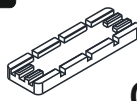

ACCESSORY LIST

A22 Minifix k18  48x	A23 Minifix M10  48x	A04 $\varnothing 8$  44x	B03 25 mm  8x	A12 4 SW  1x
A26 Allen  1x	A08 5 mm  C2-6x	A06 18 mm  C2-56x	A69 P.D.  8x	

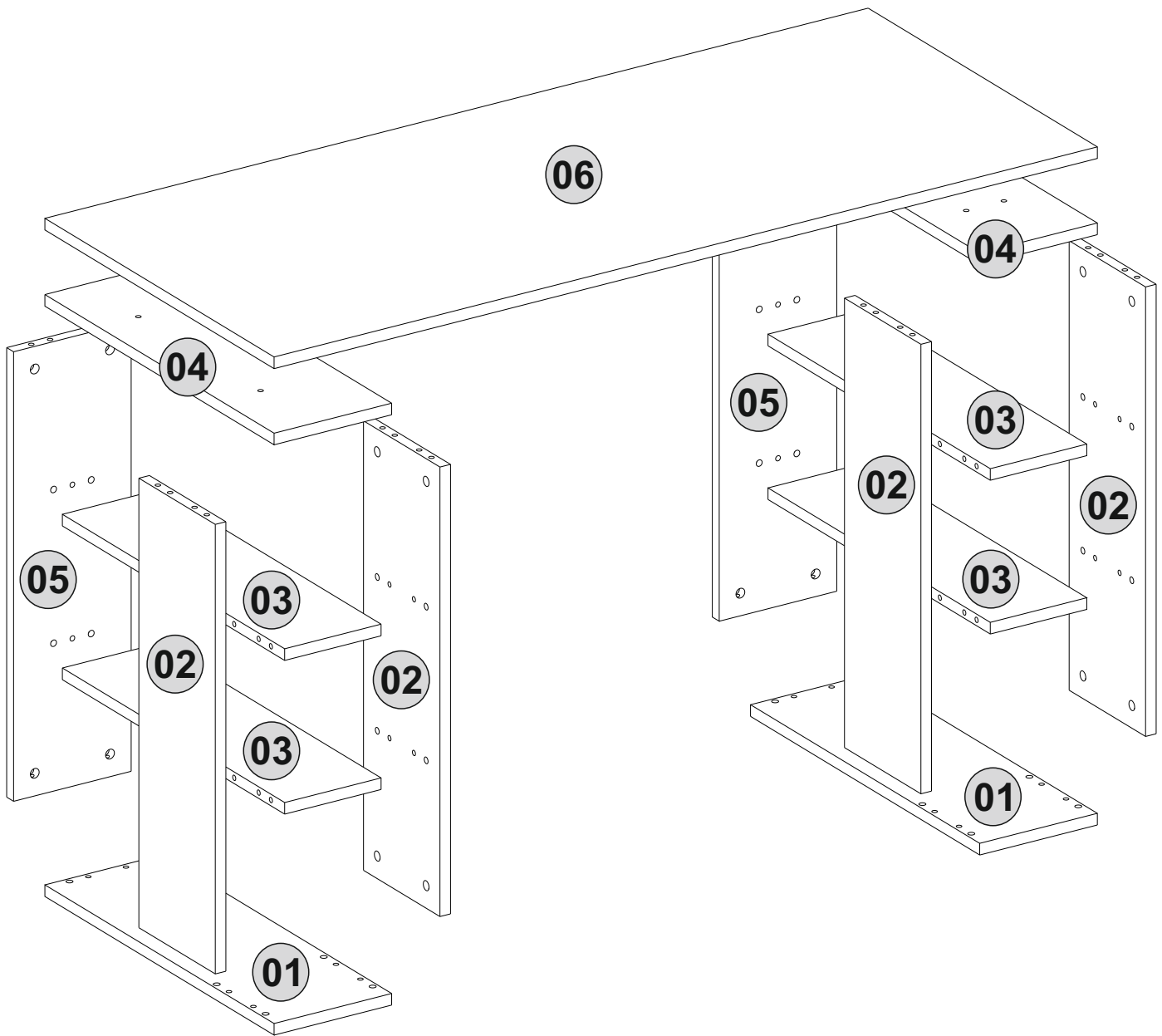

1. step

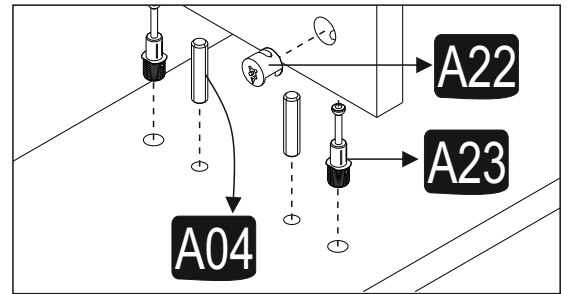
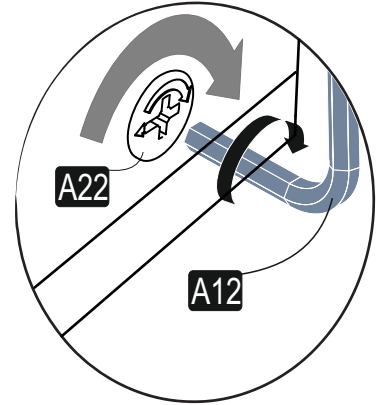
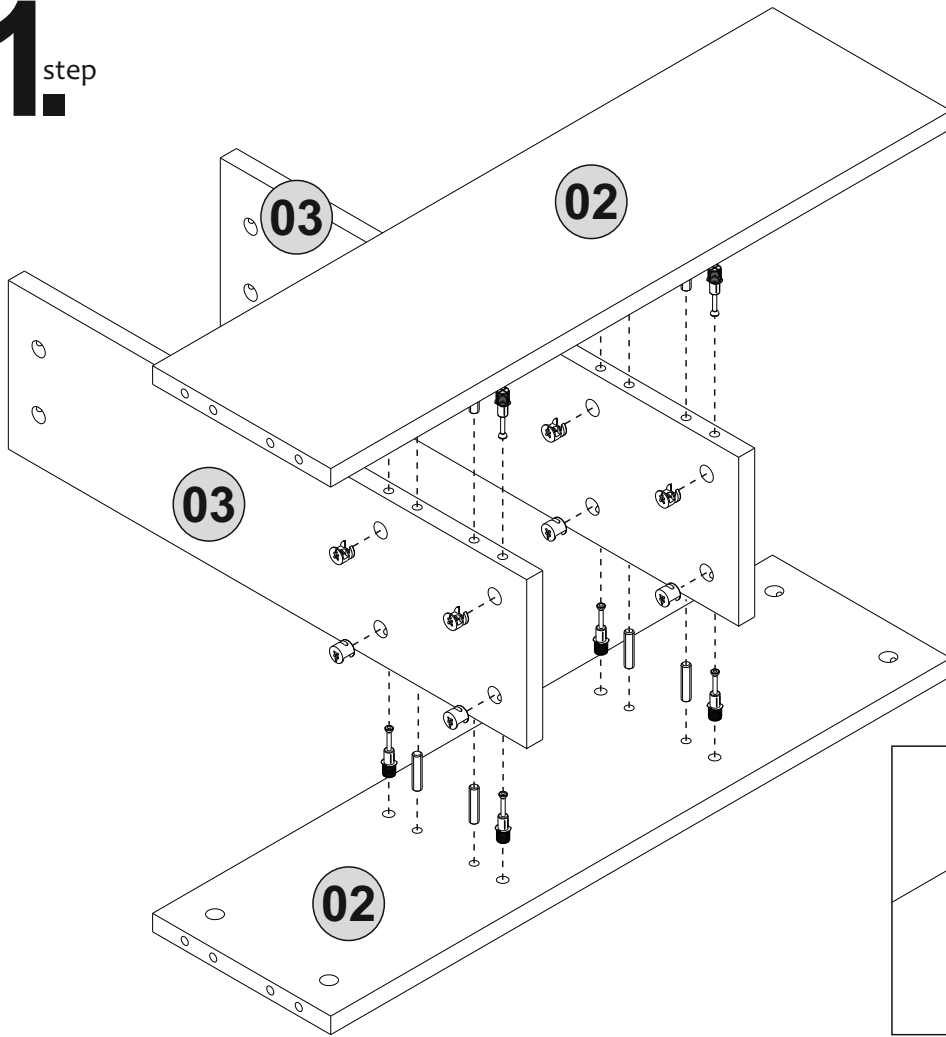

2. step

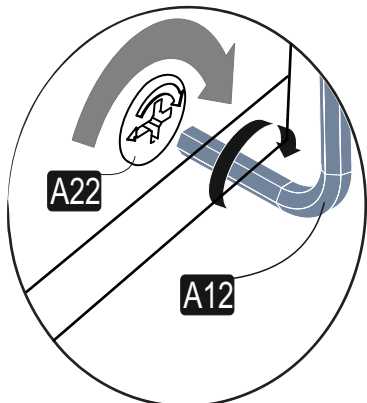
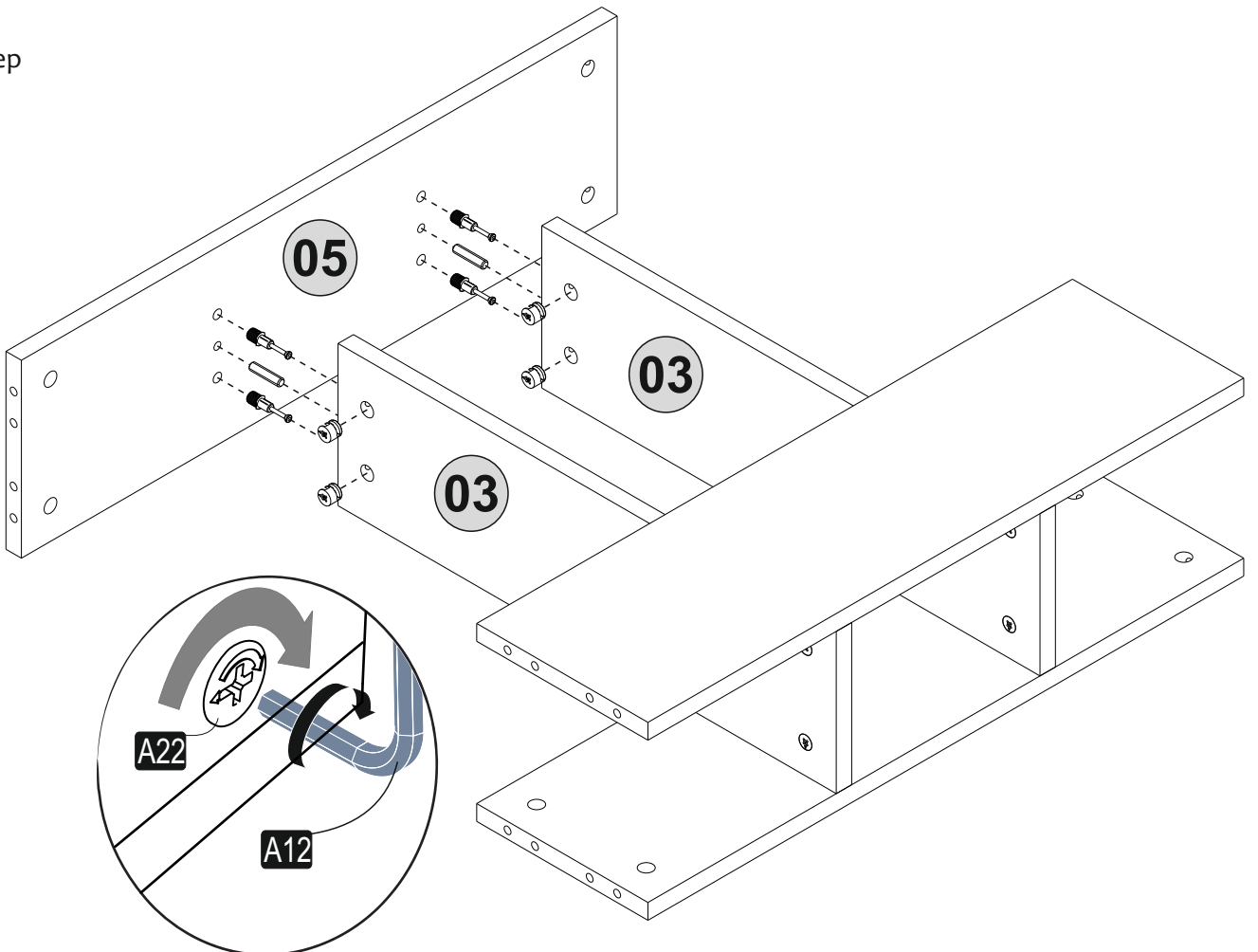

3^{step}

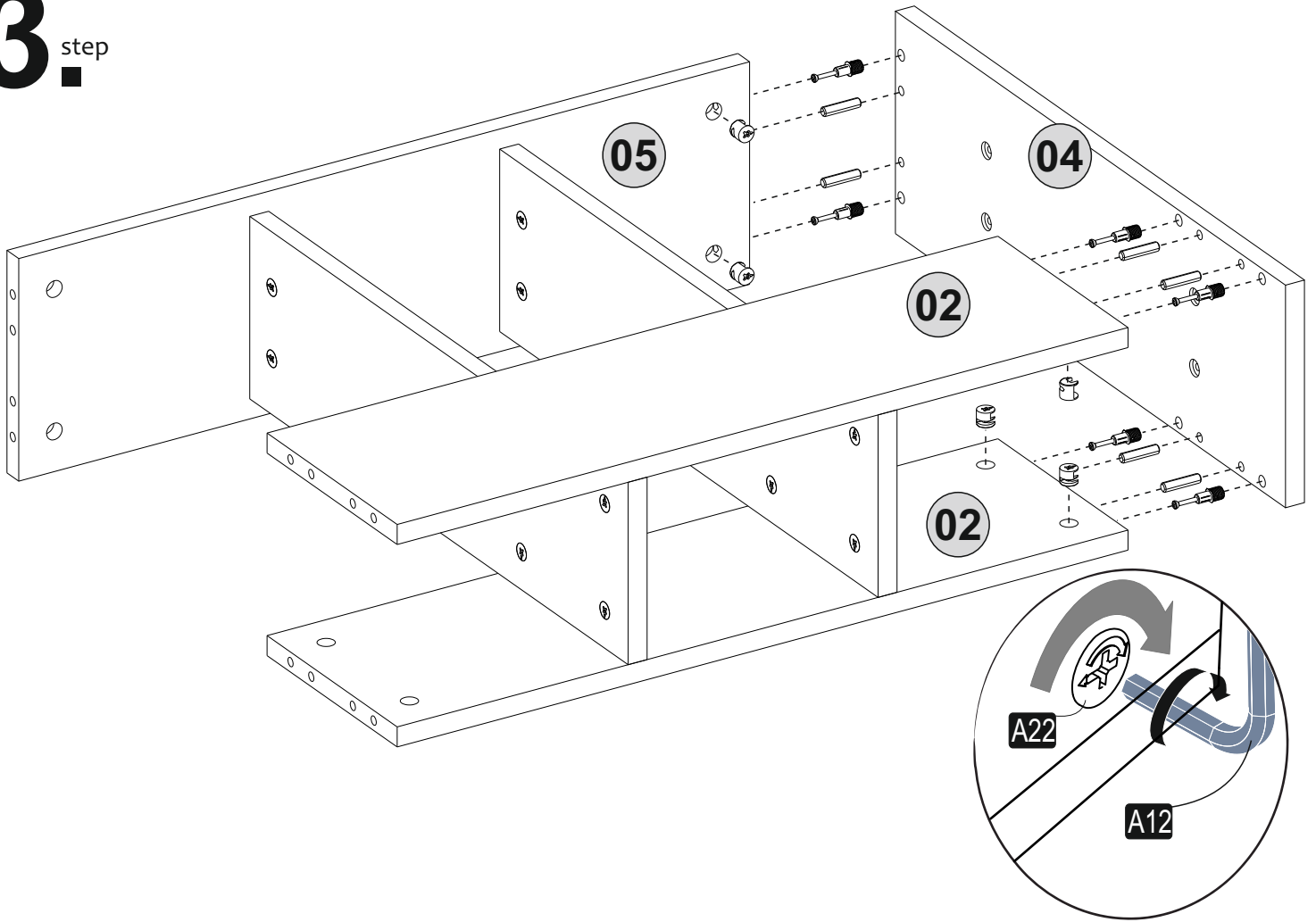

4^{step}

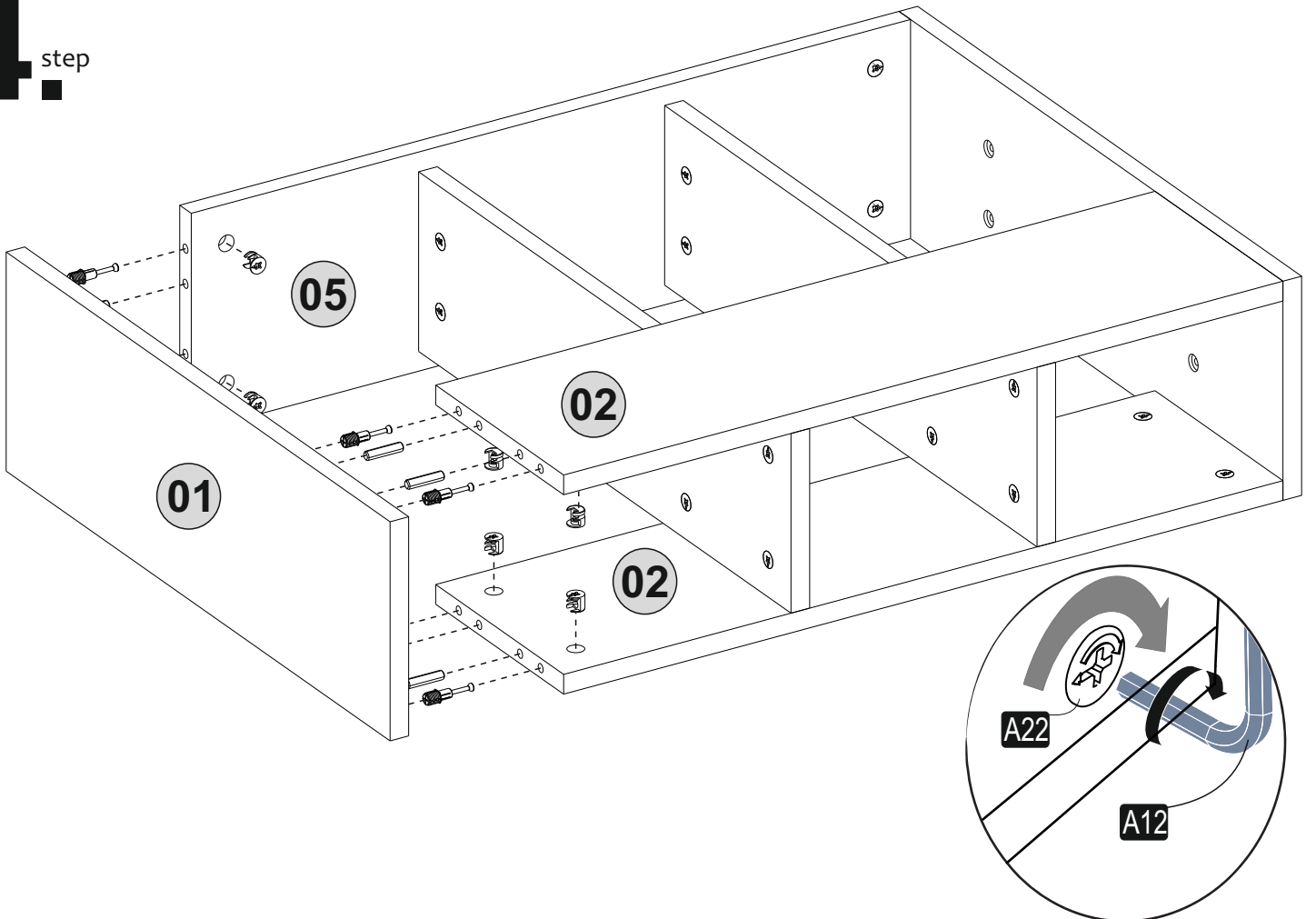

5. step

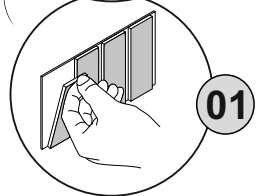
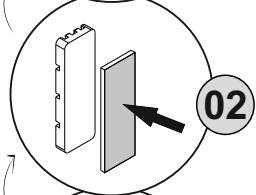
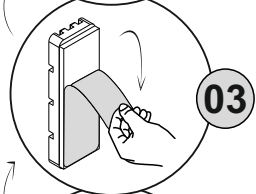
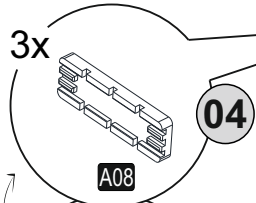
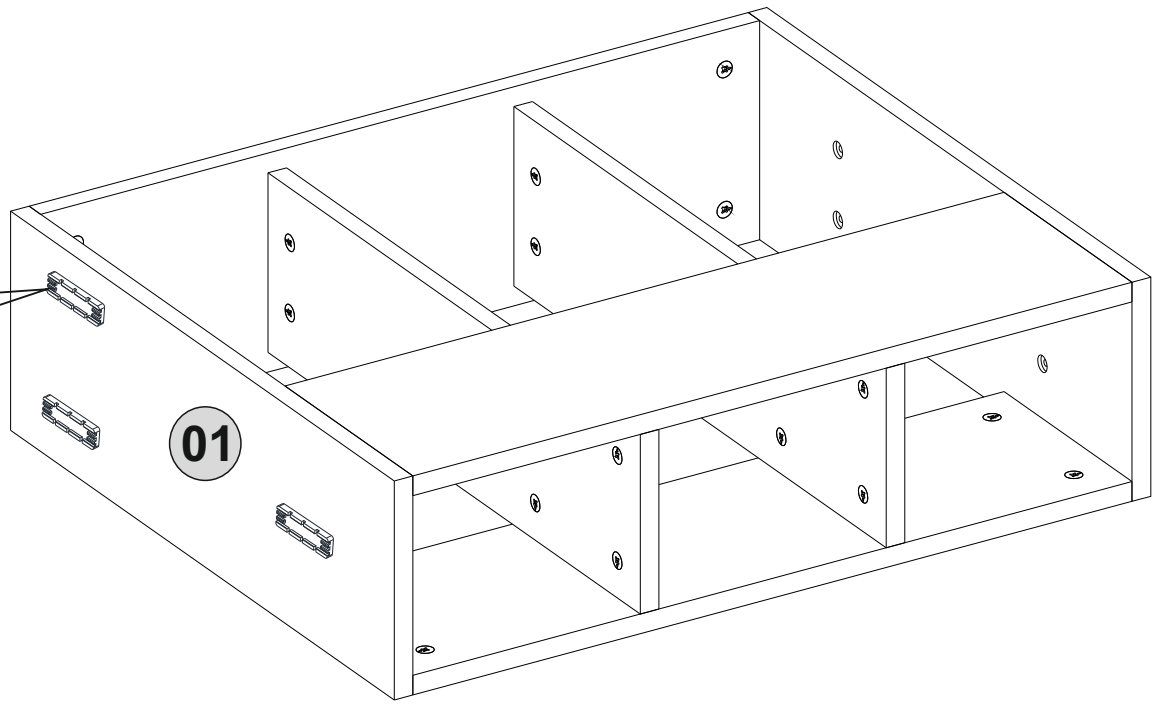

6. step

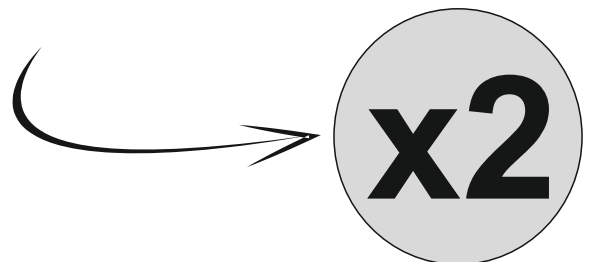
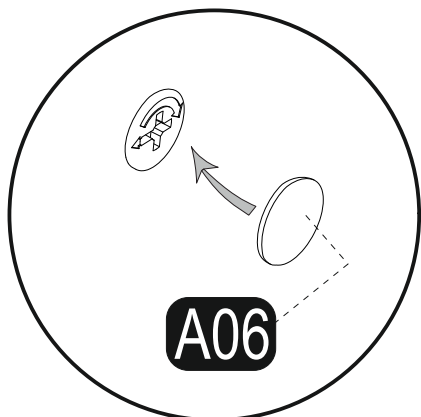
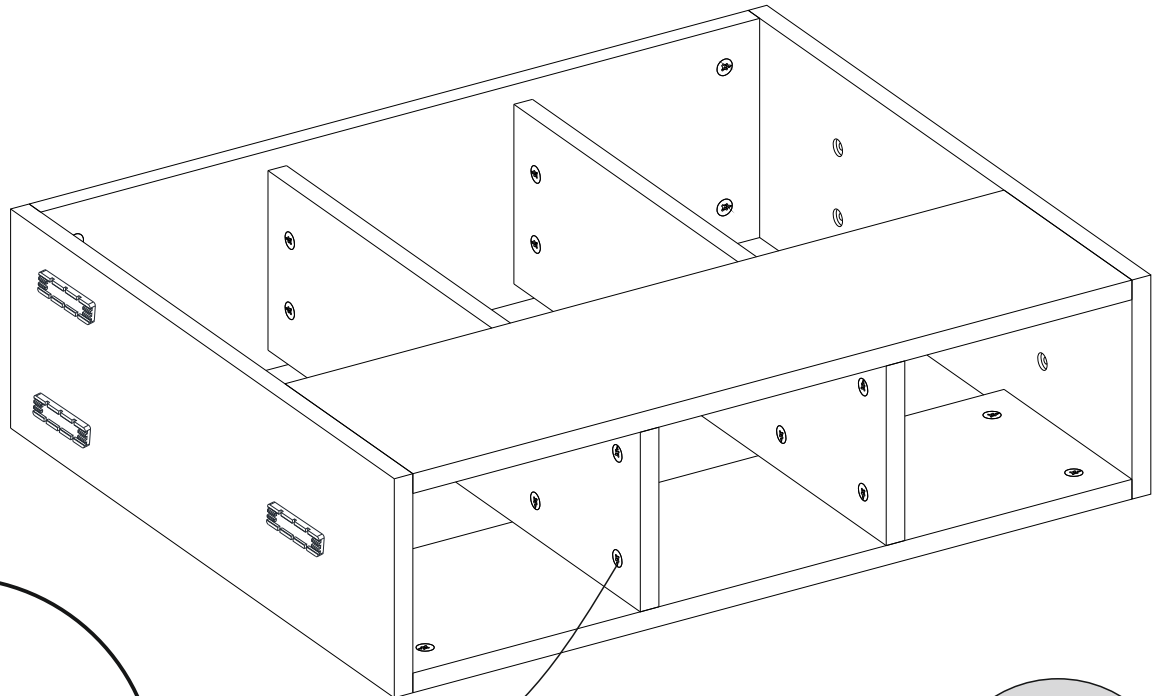

7 step

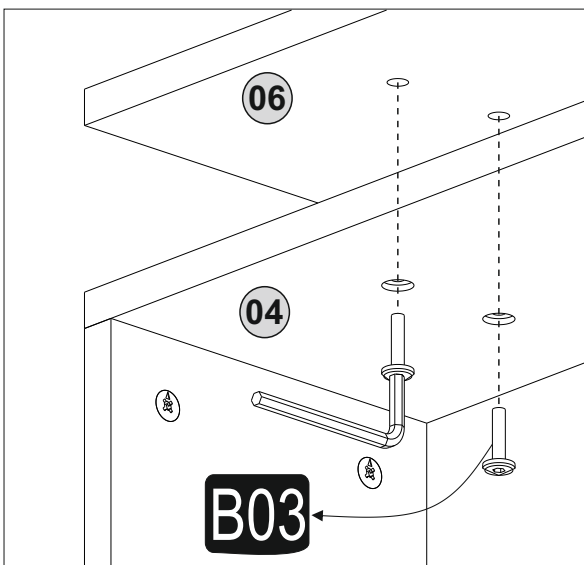
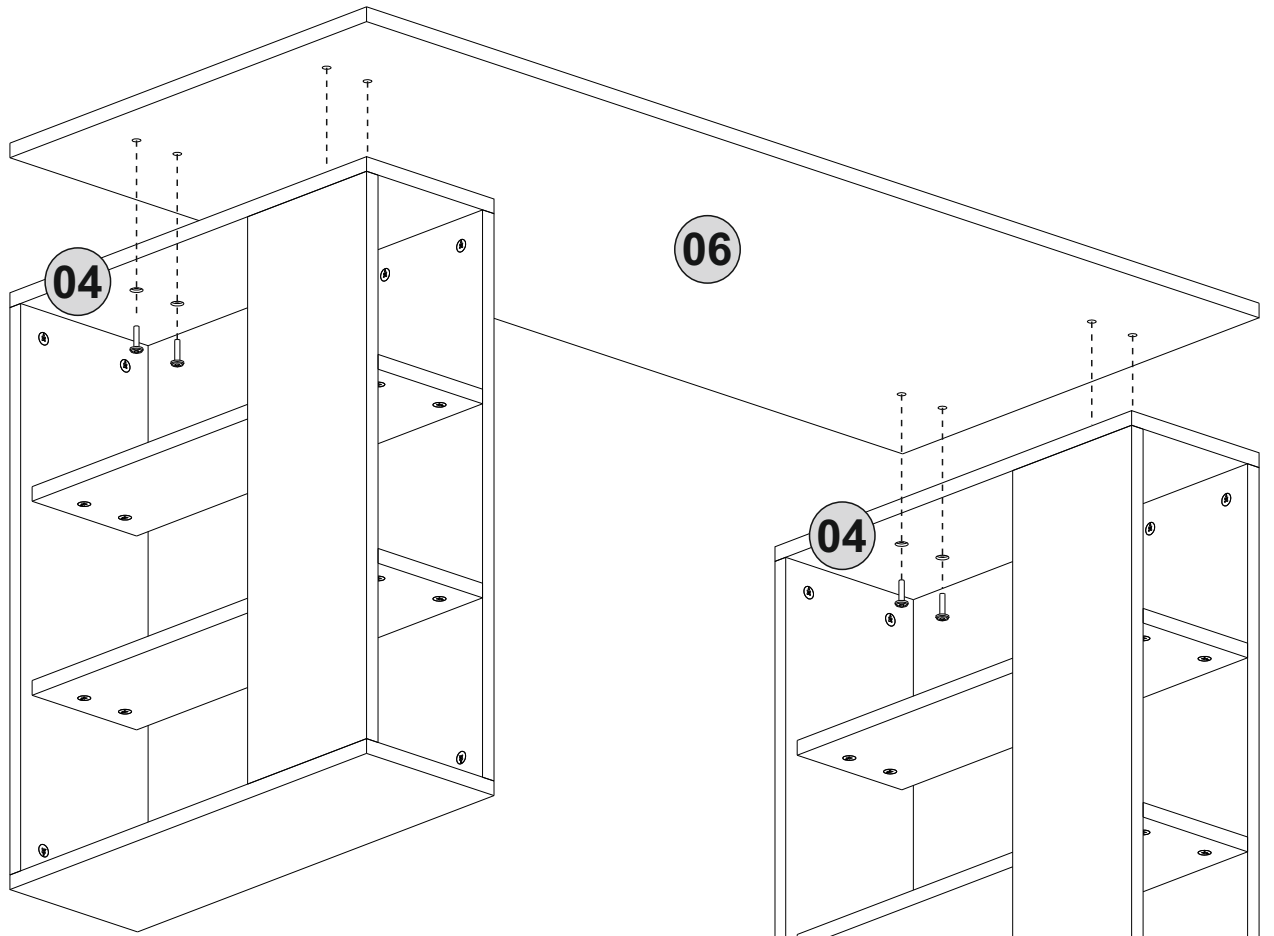
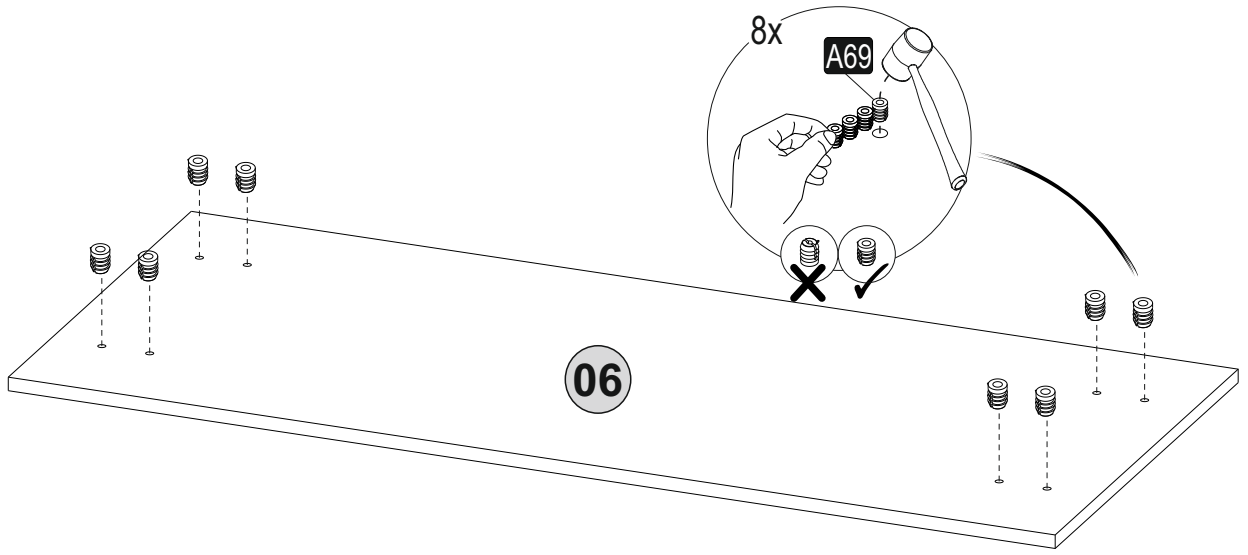

8 step

