

GP037-0004,2

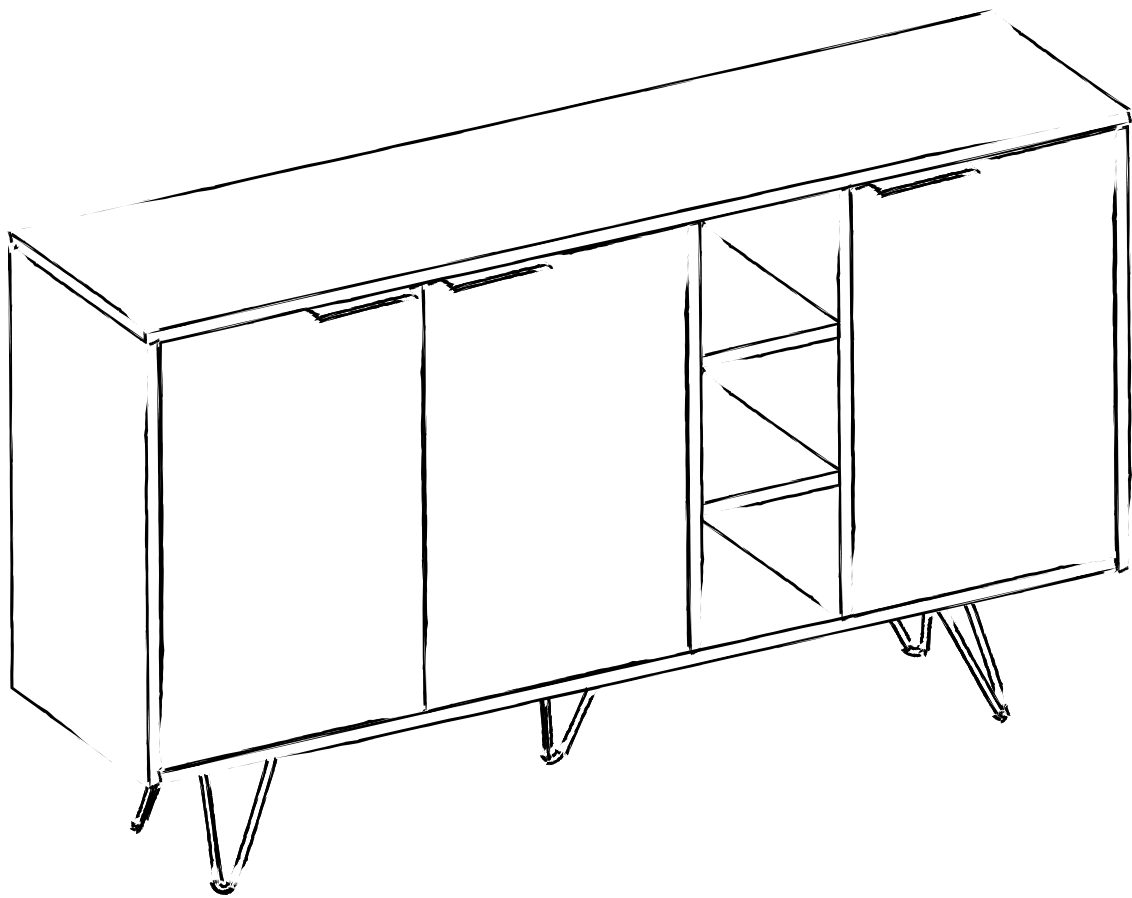

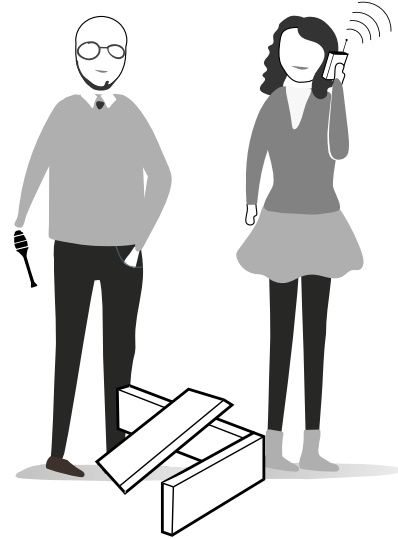
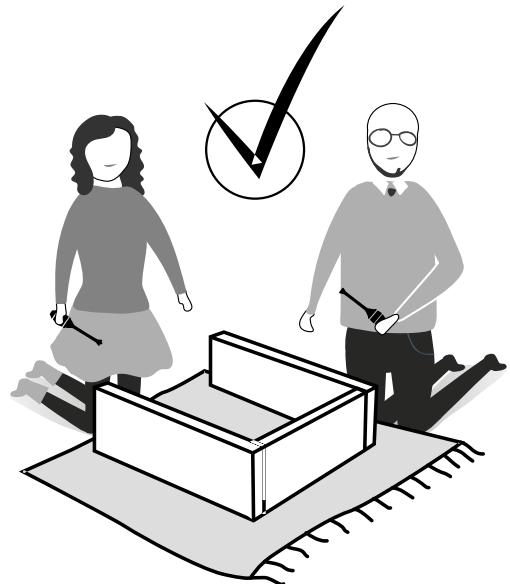
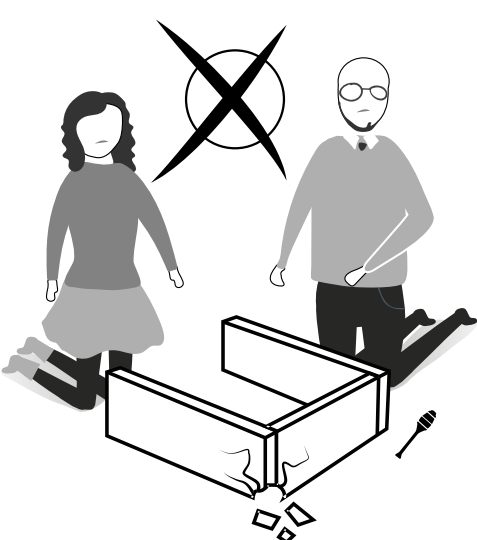
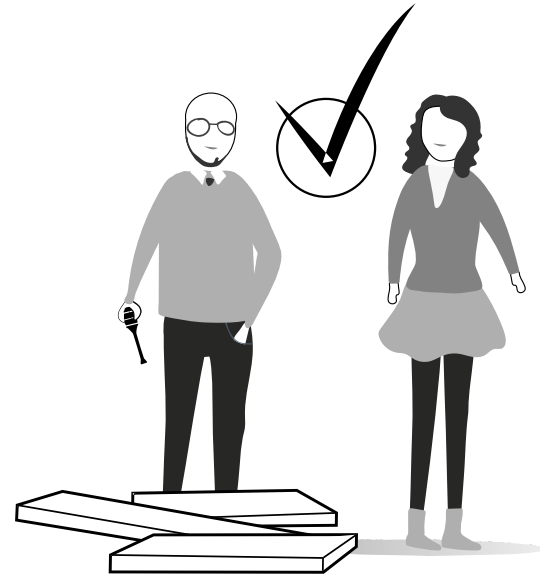
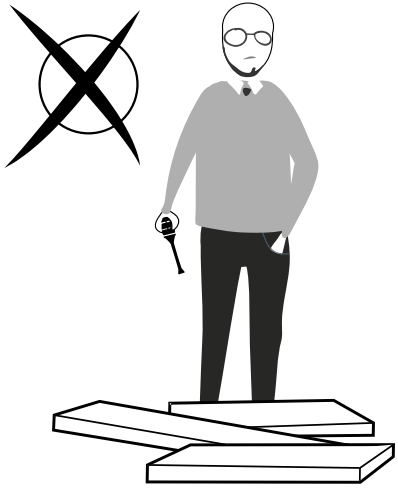

ATTENTION !!

Minifix is the main connection material used in our products.
Before starting assembly, please check the drawings below.

A04

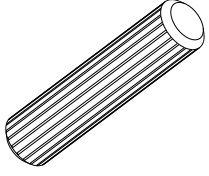

A23

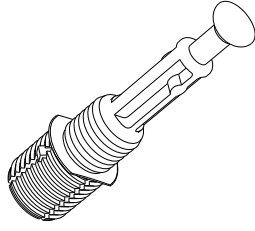

A22

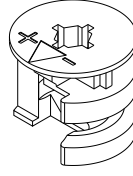

A12

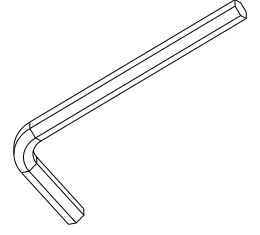

1

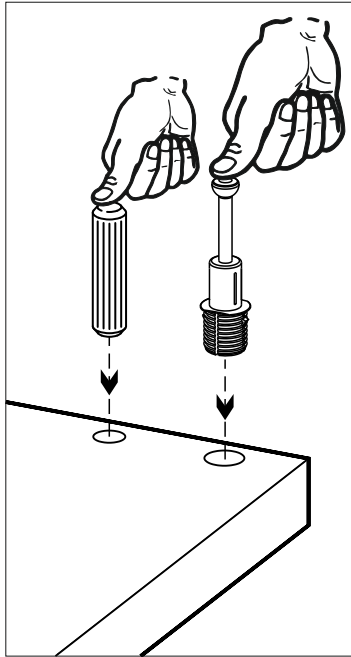

2

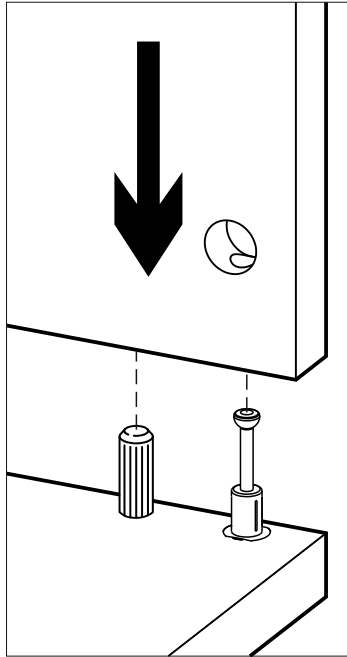

3

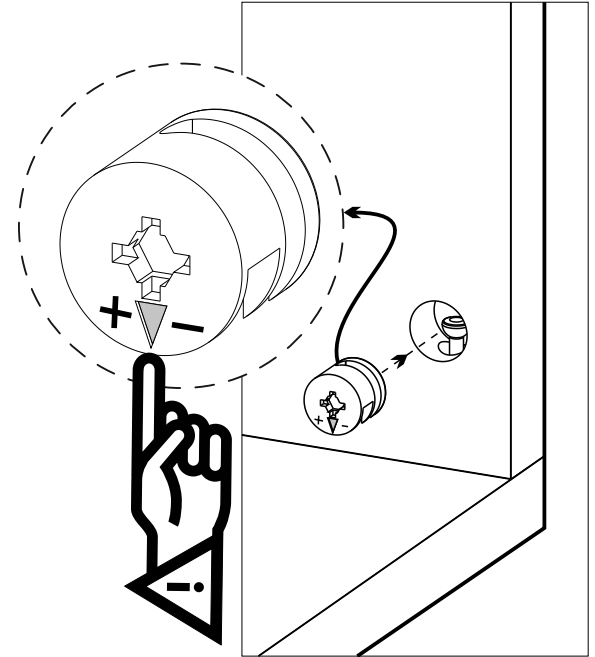



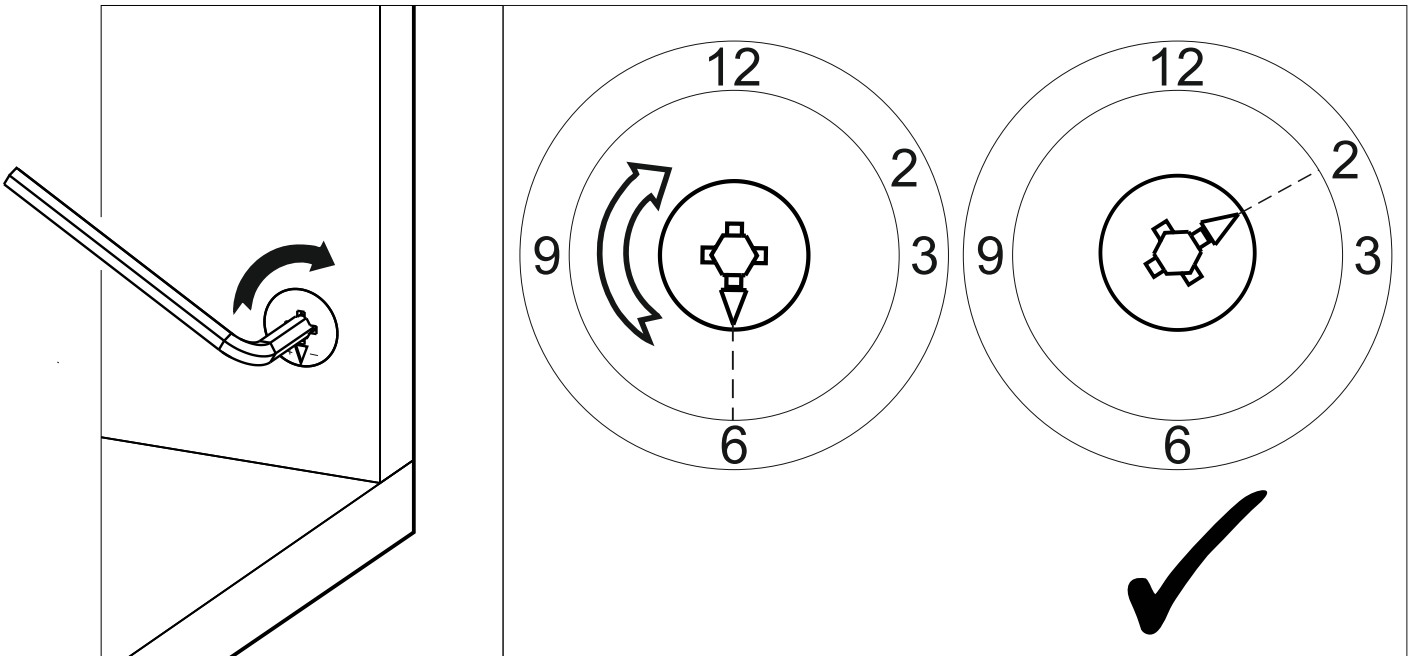







4

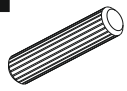

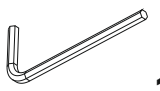
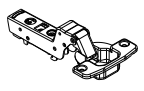
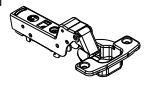
Follow the installation steps in the order as shown.
Position the parts as shown in the installation guide steps.

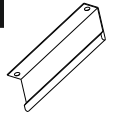
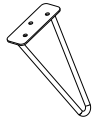

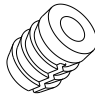
ACCESSORY LIST

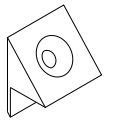
A22 Minifix k18  24x	A23 Minifix M10  24x	A04 Ø8  24x	A13 50mm  8x	A12 4 SW  1x
C19 SdbF(S)  3x	C16 Sdb(S)  3x	C20 Mtk(S)  6x	A18 3,5x18  54x	Z51 K128mm (black)  3x
Z88 MBA  5x	B15 15 (black)mm  15x	A69 P.D.  15x	A06 18mm  32x	A25 ARK.PL  12x

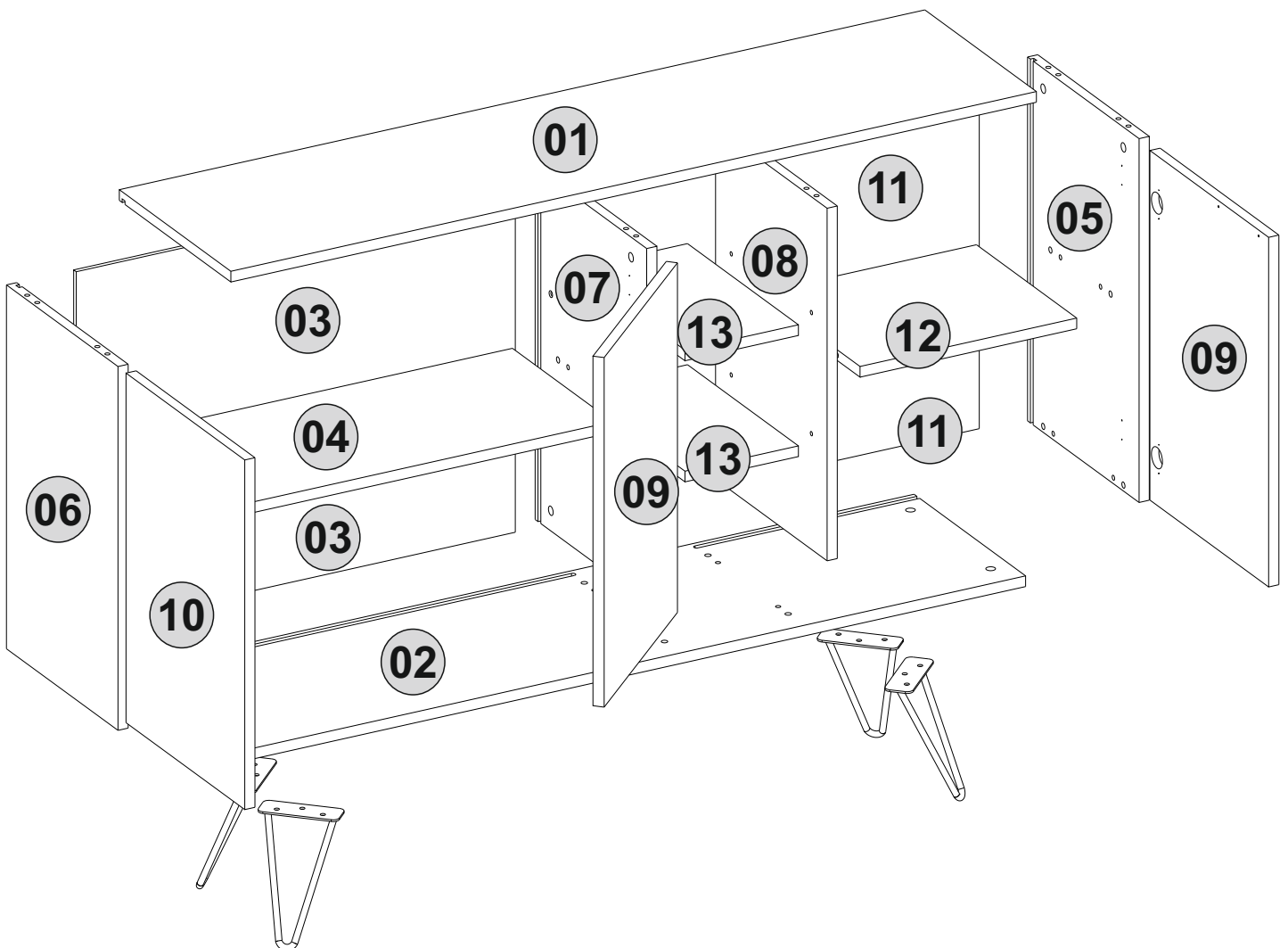

1. step

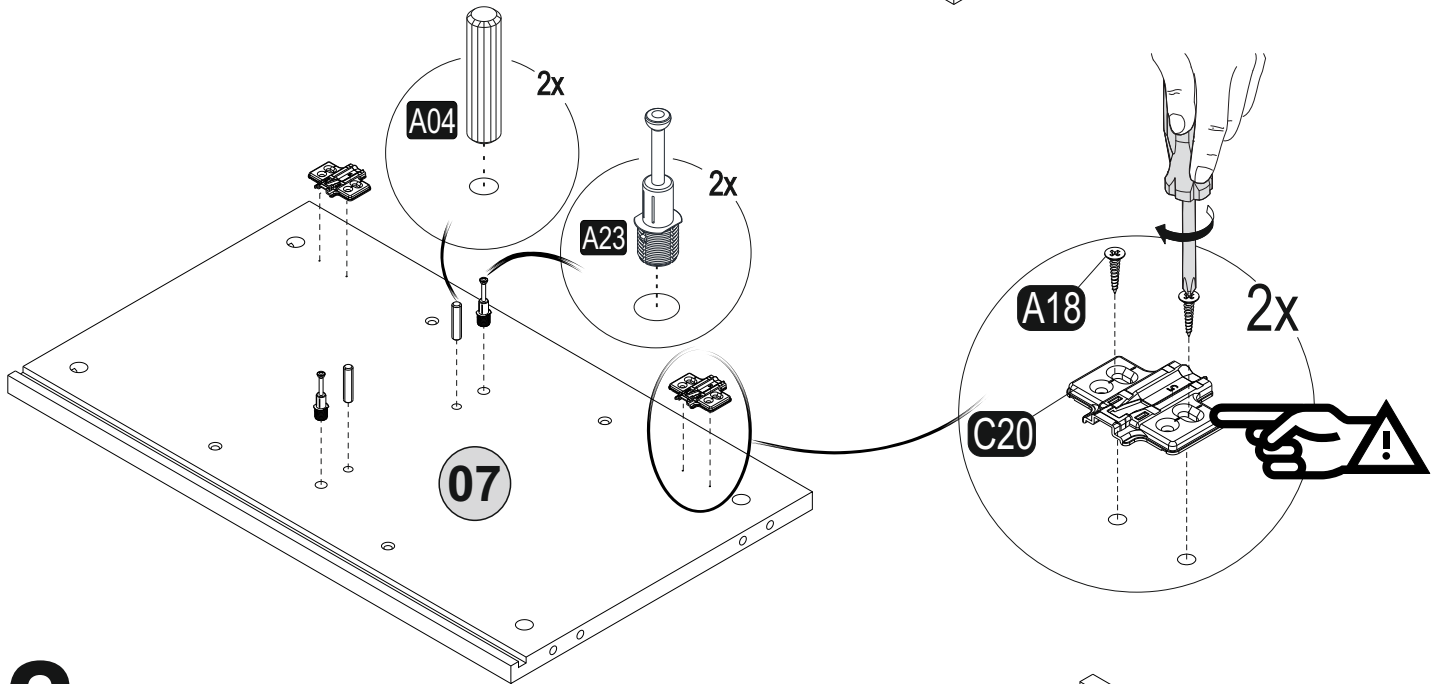
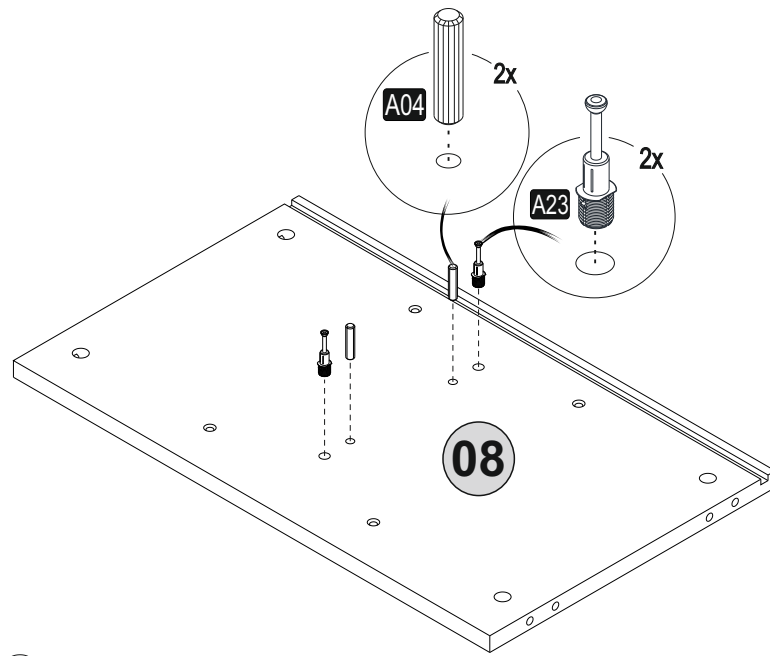

2. step

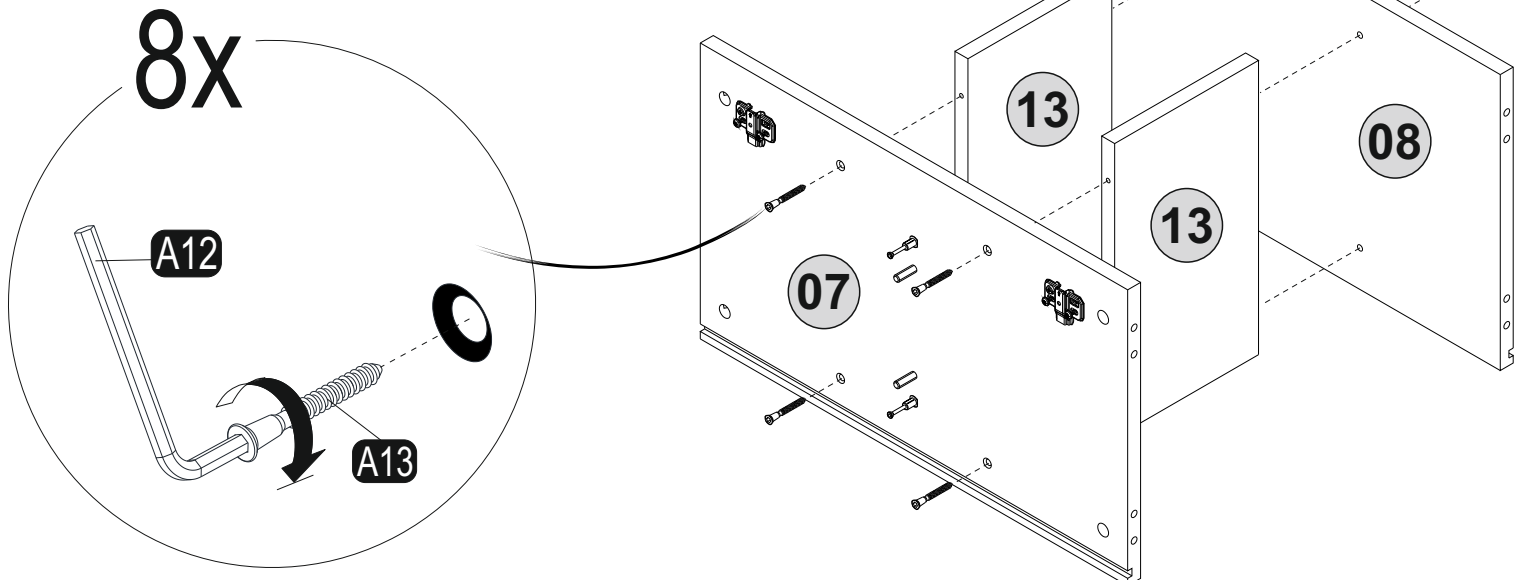

3 step

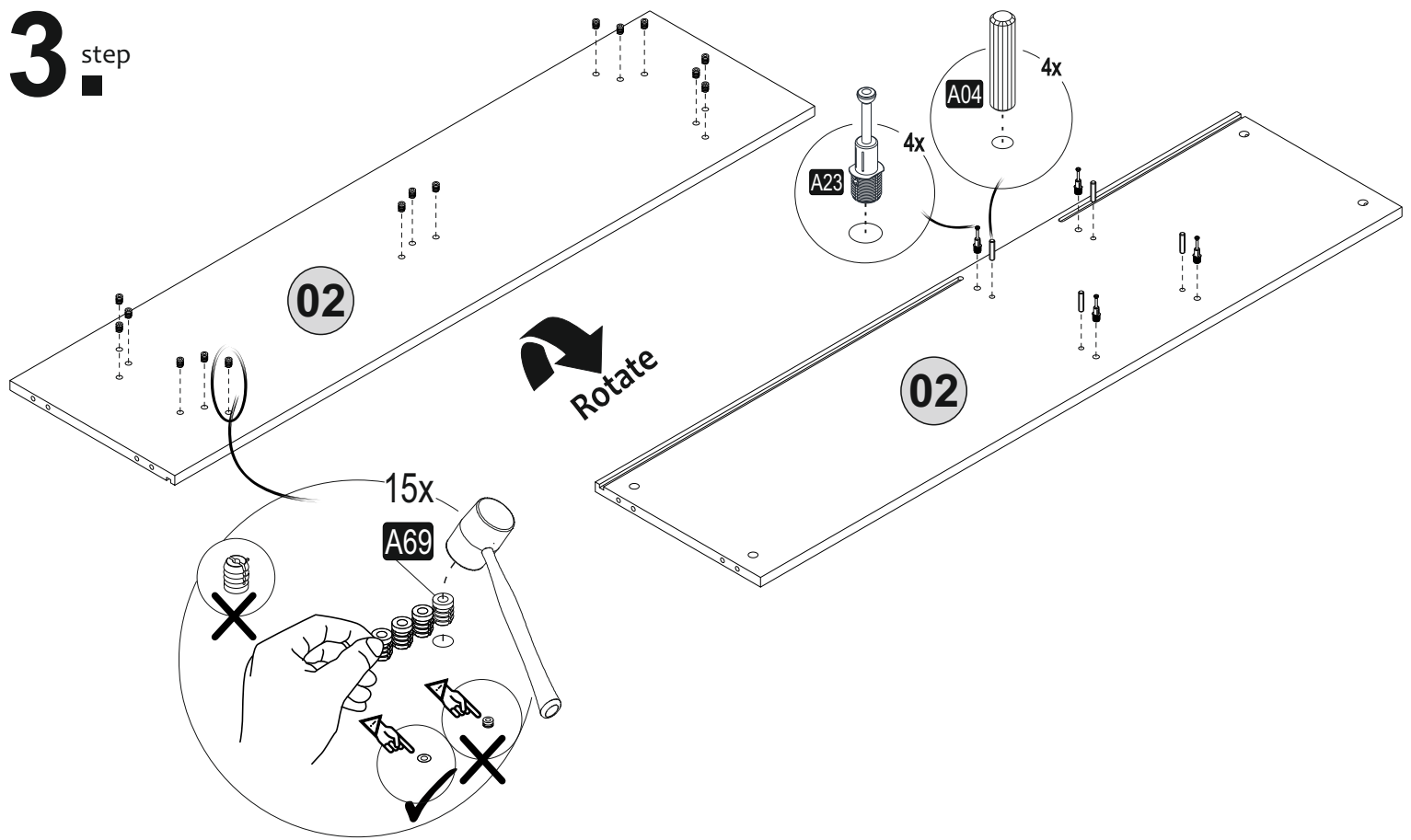

4 step

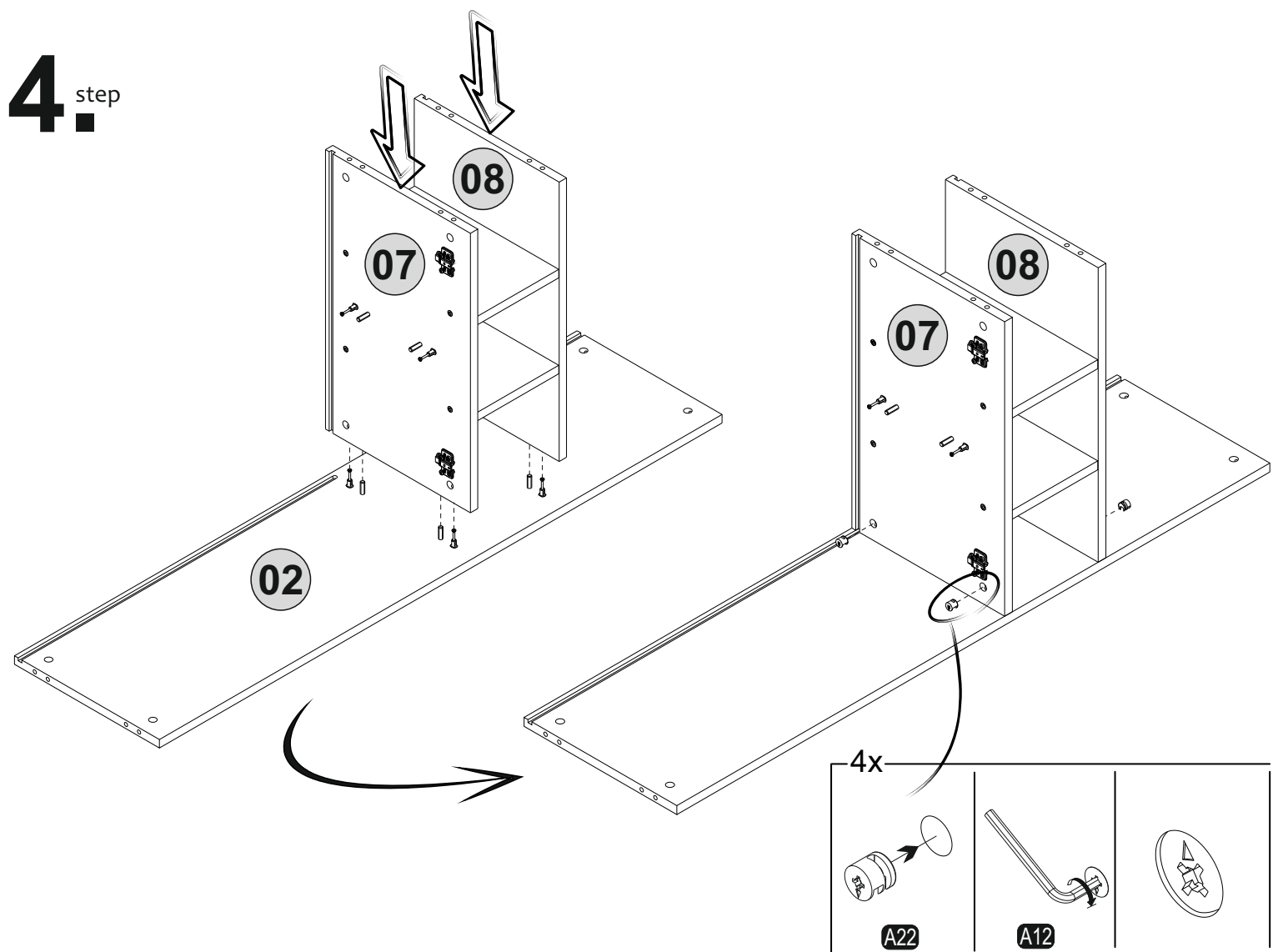

5^{step}

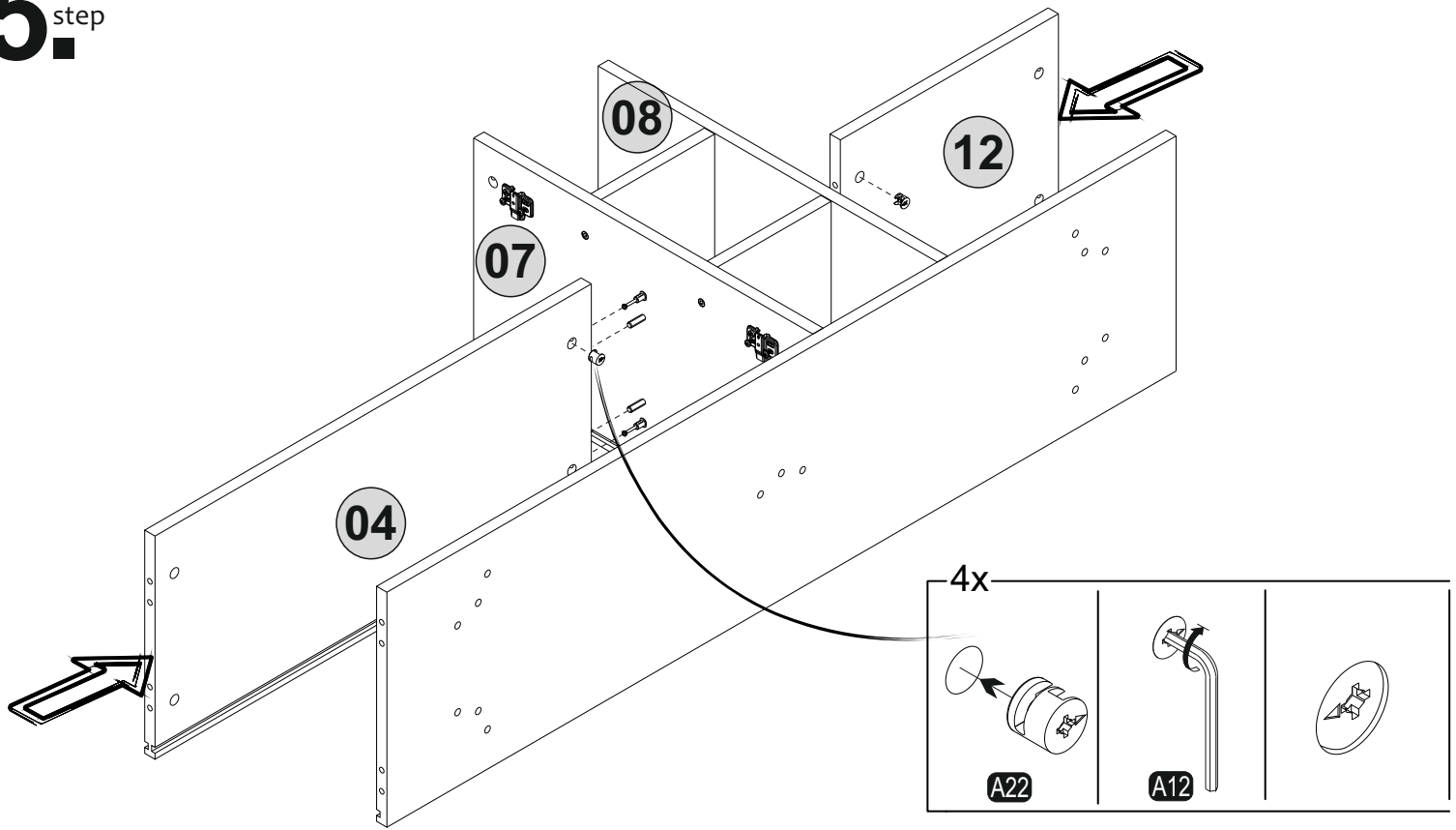

6^{step}

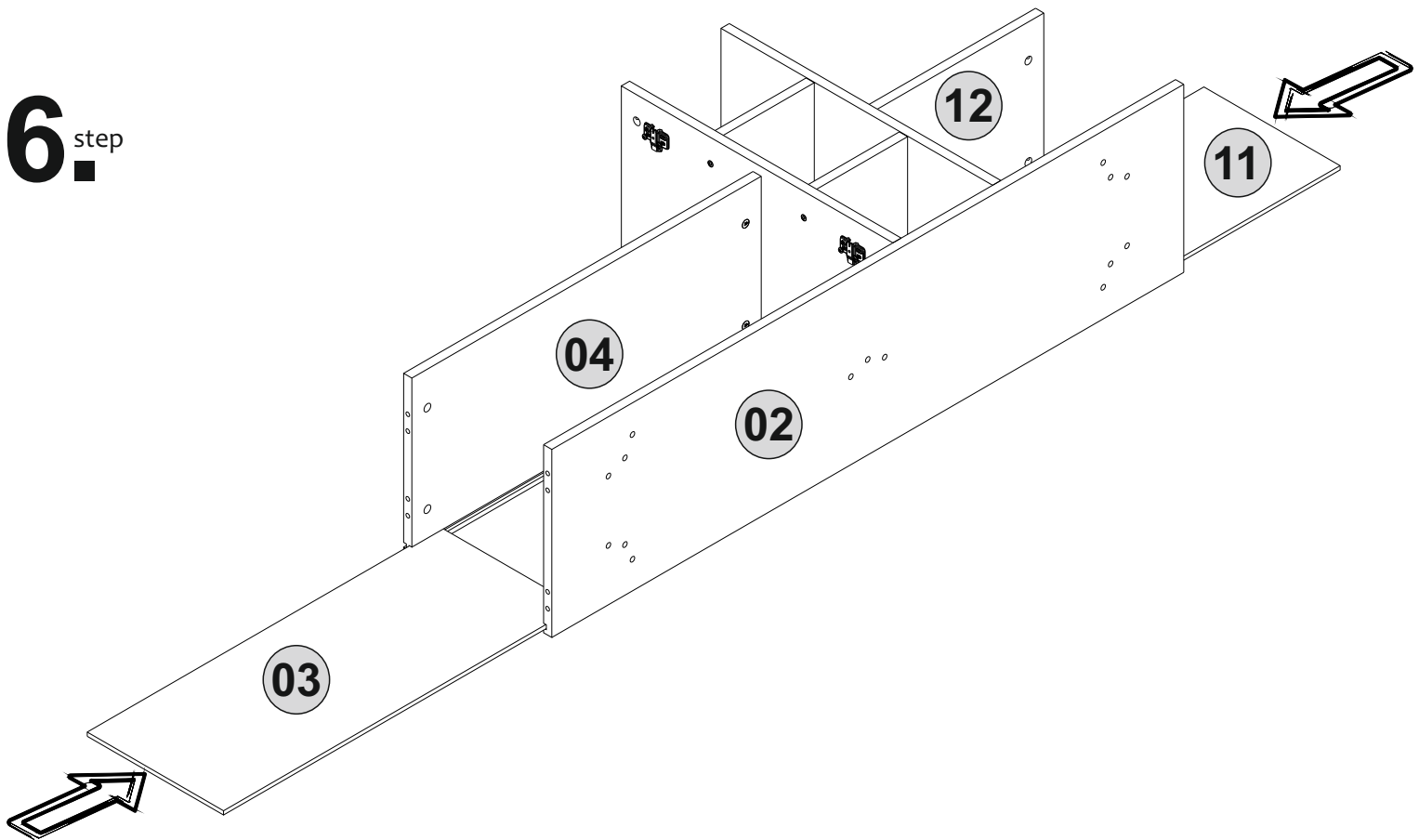

7. step

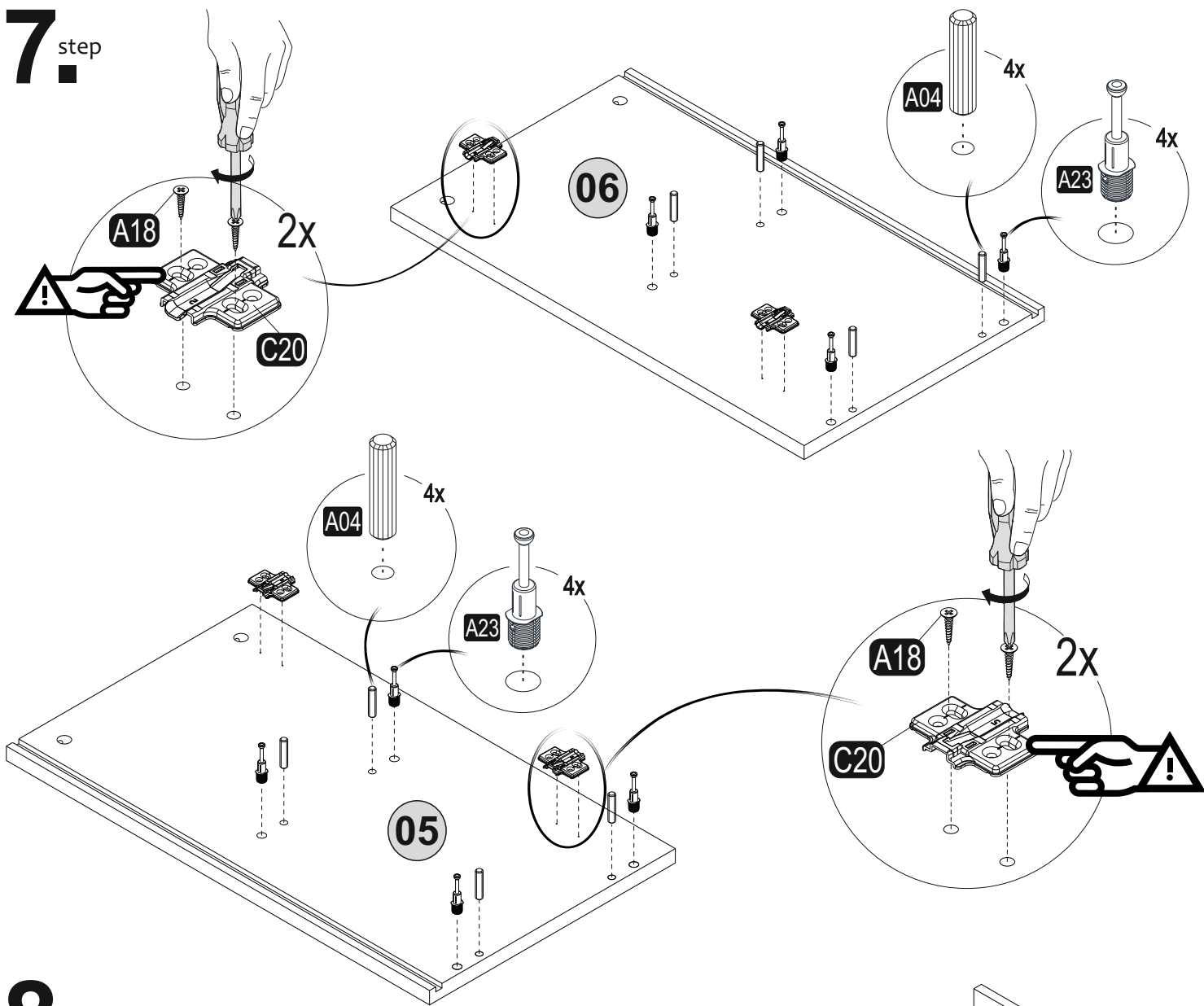

8. step

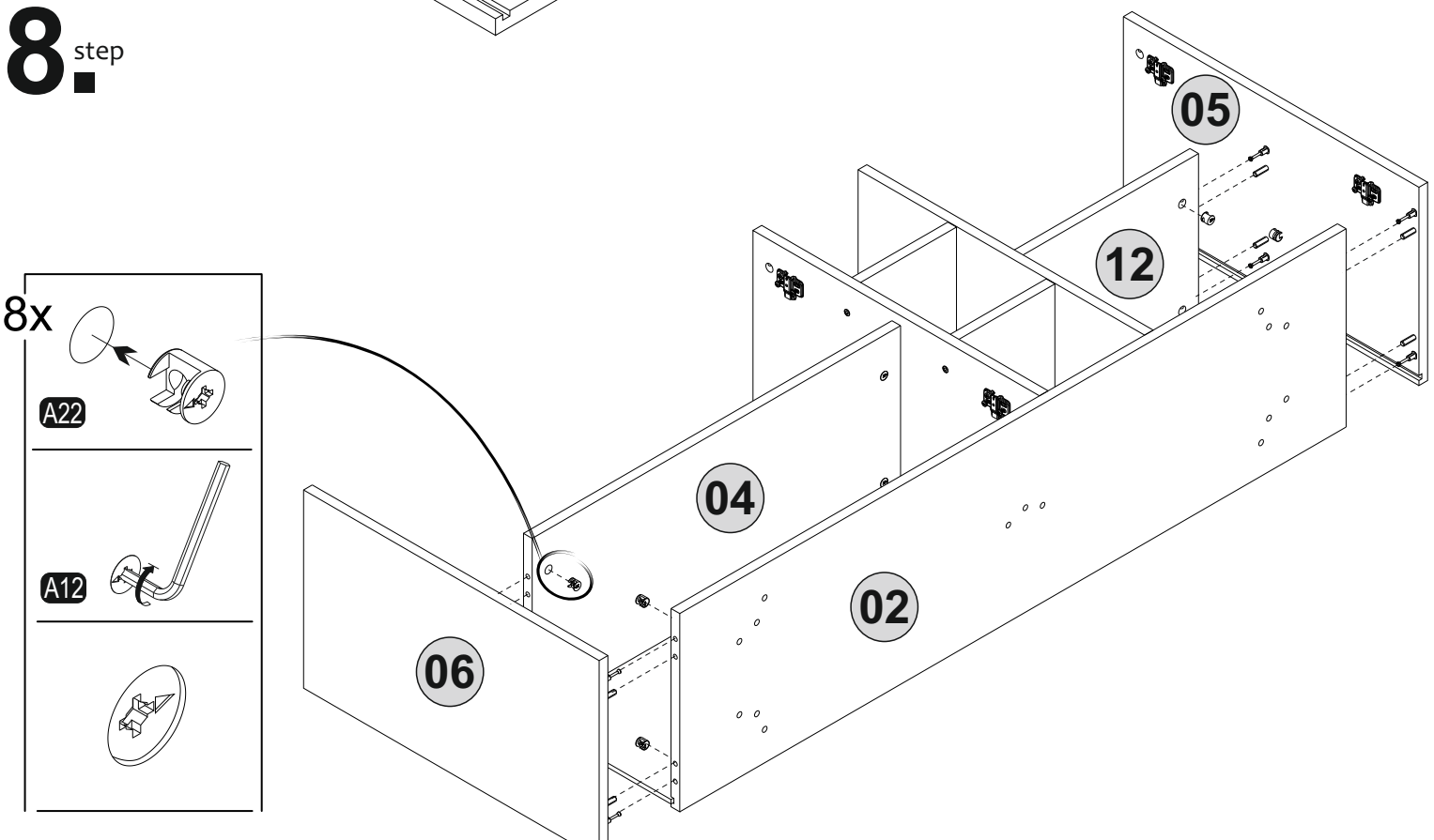

9^{step}

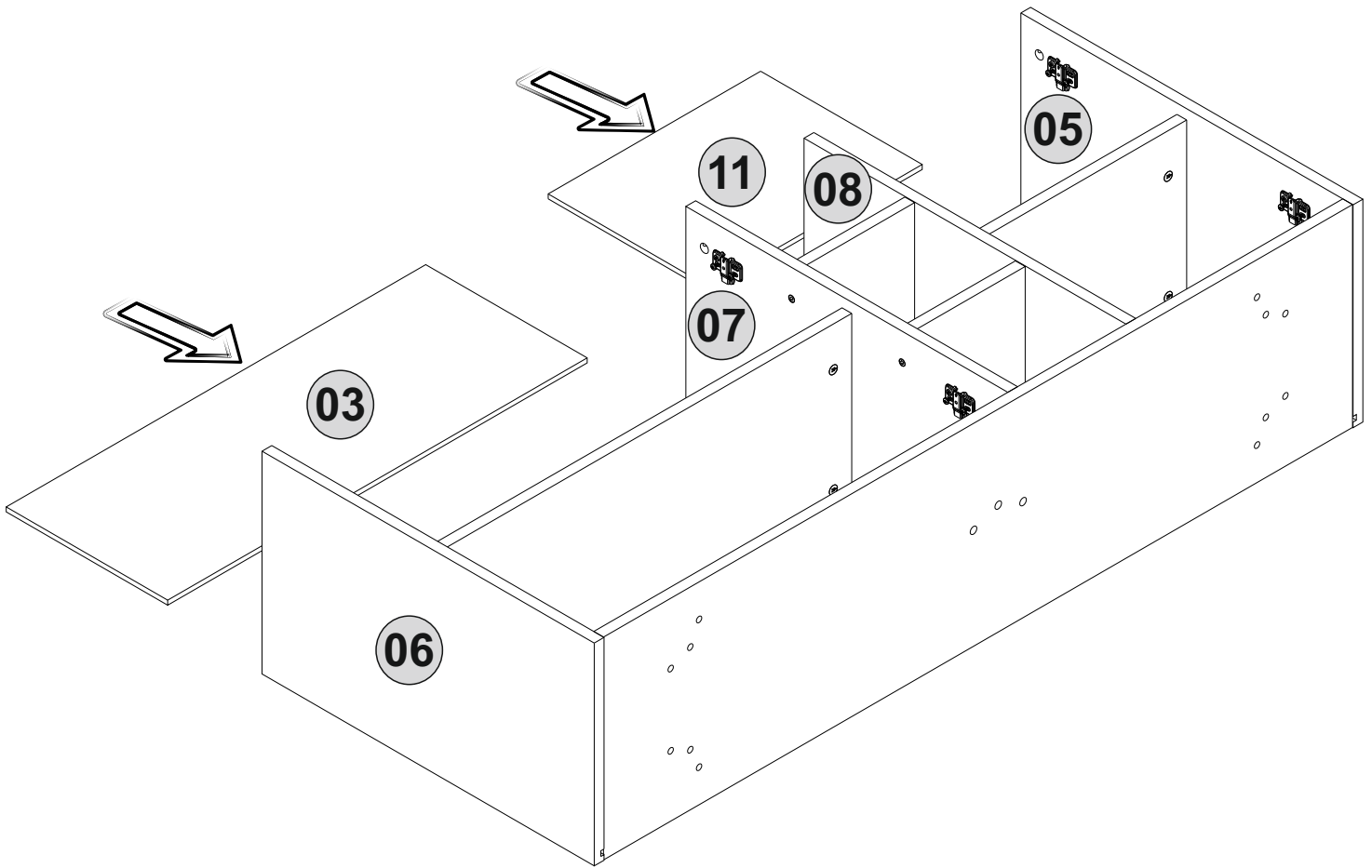

10^{step}

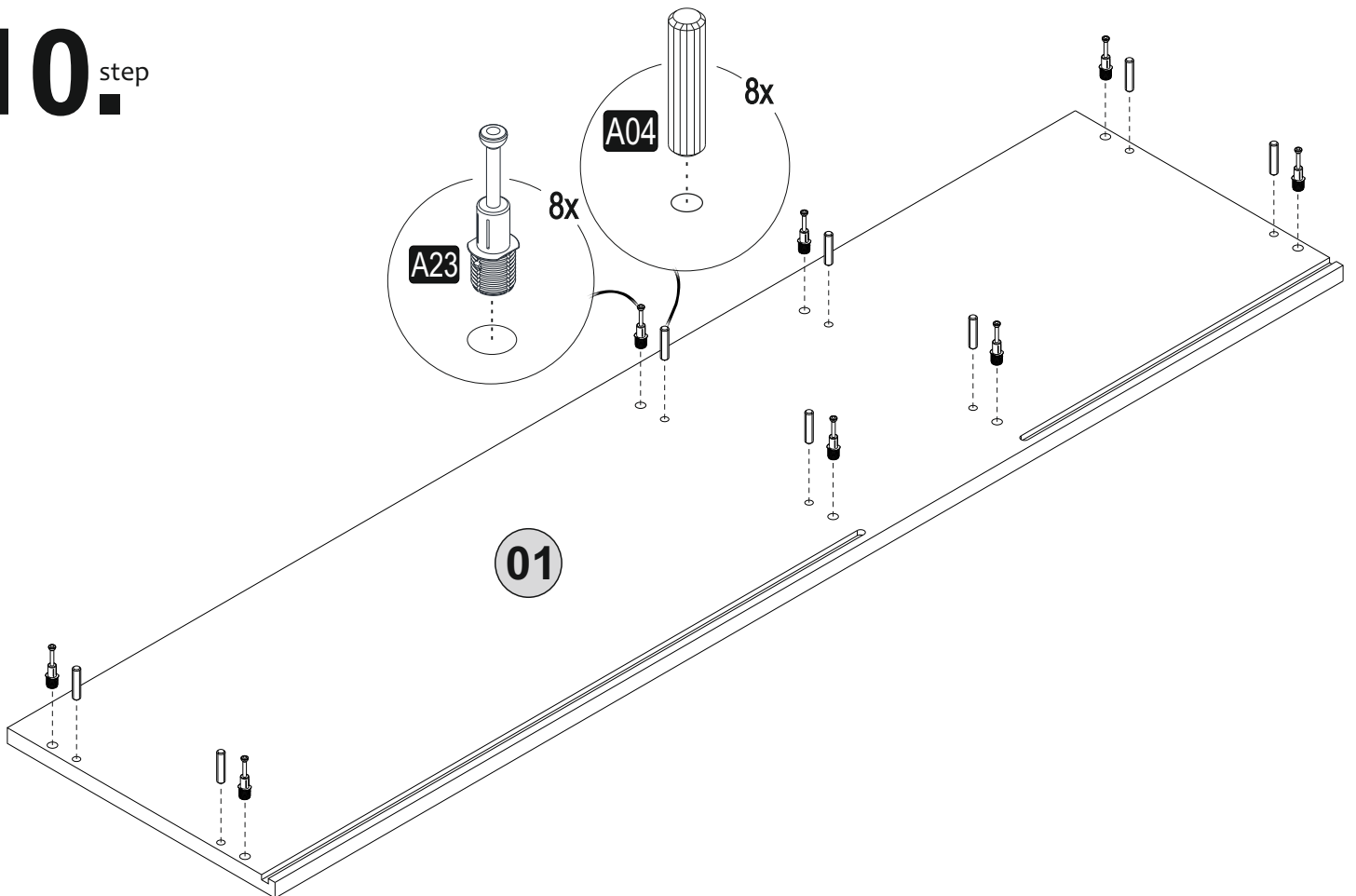

11.^{step}

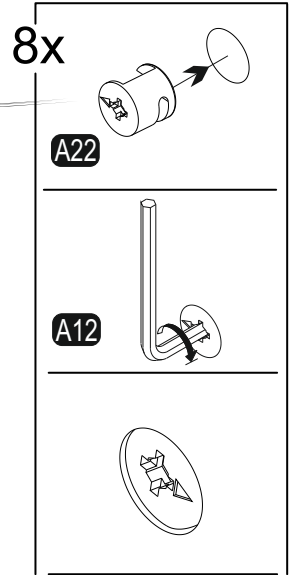
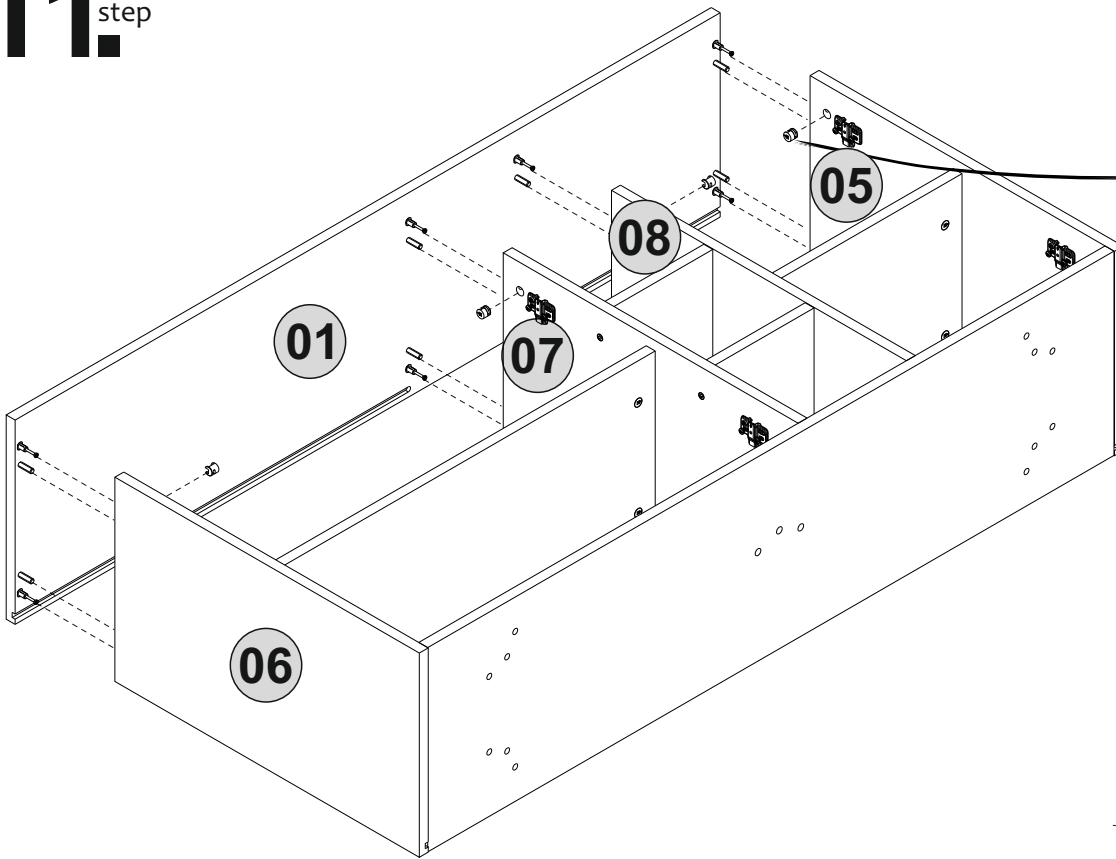

12.^{step}

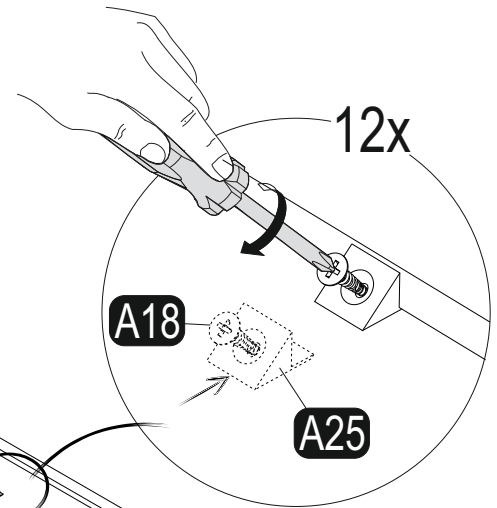
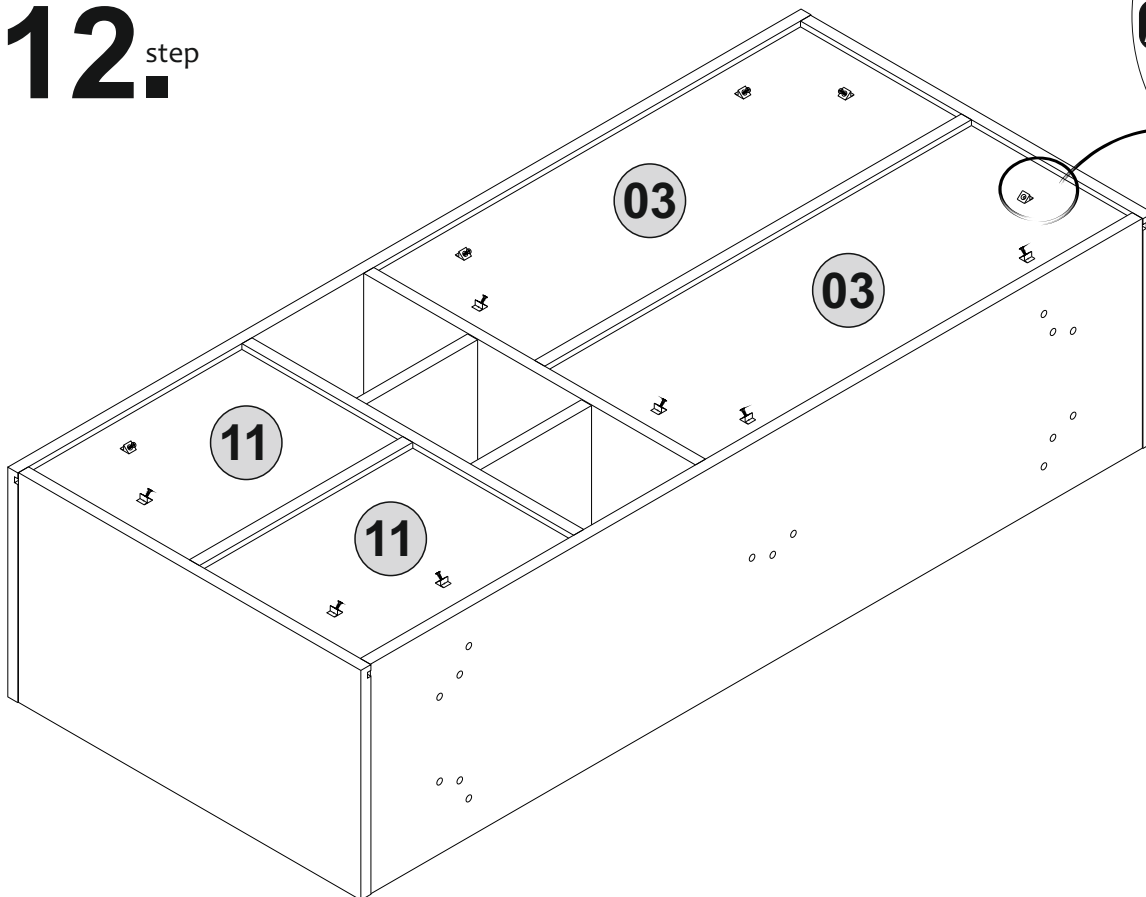

13.^{step}

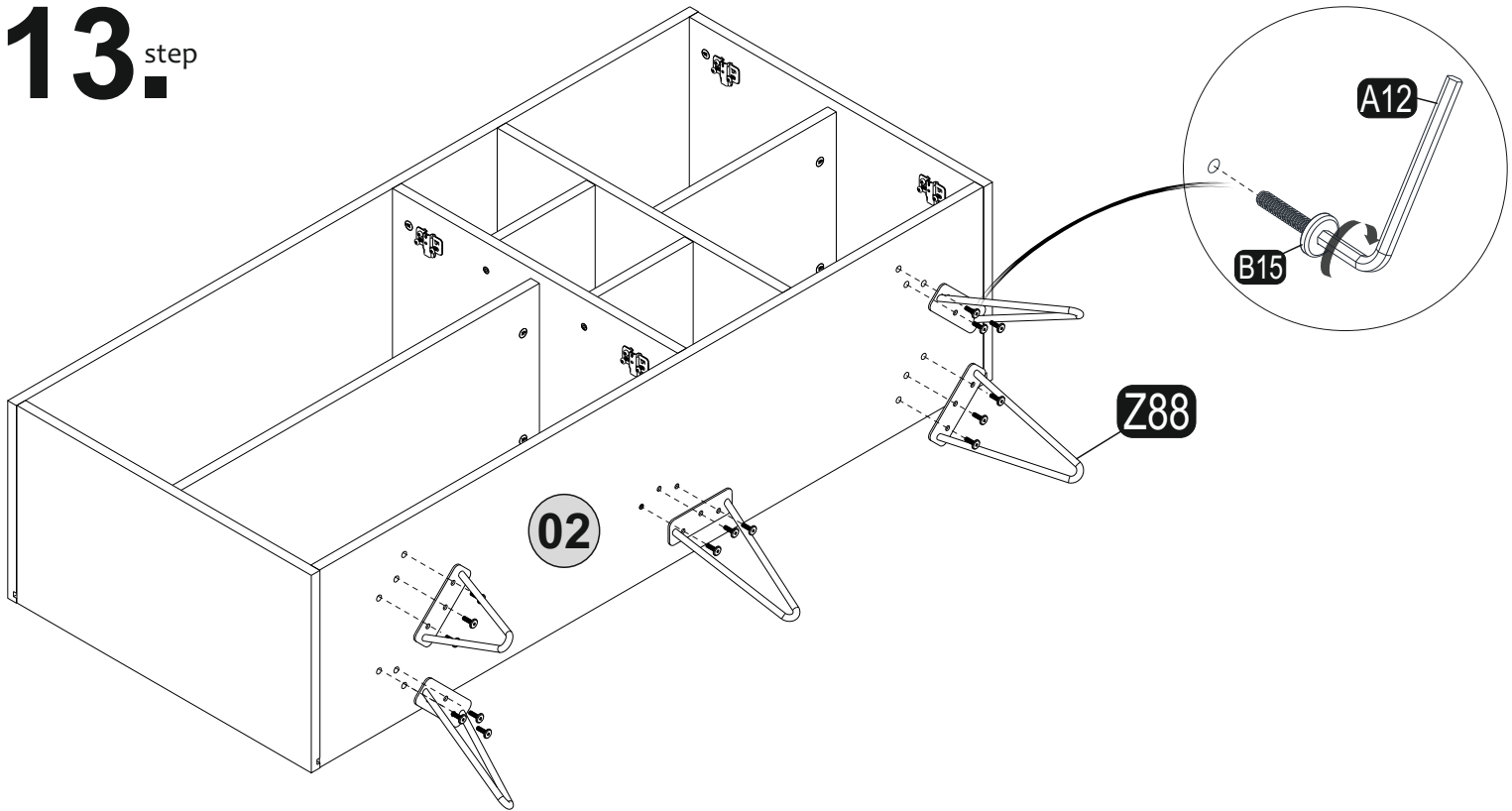

14.^{step}

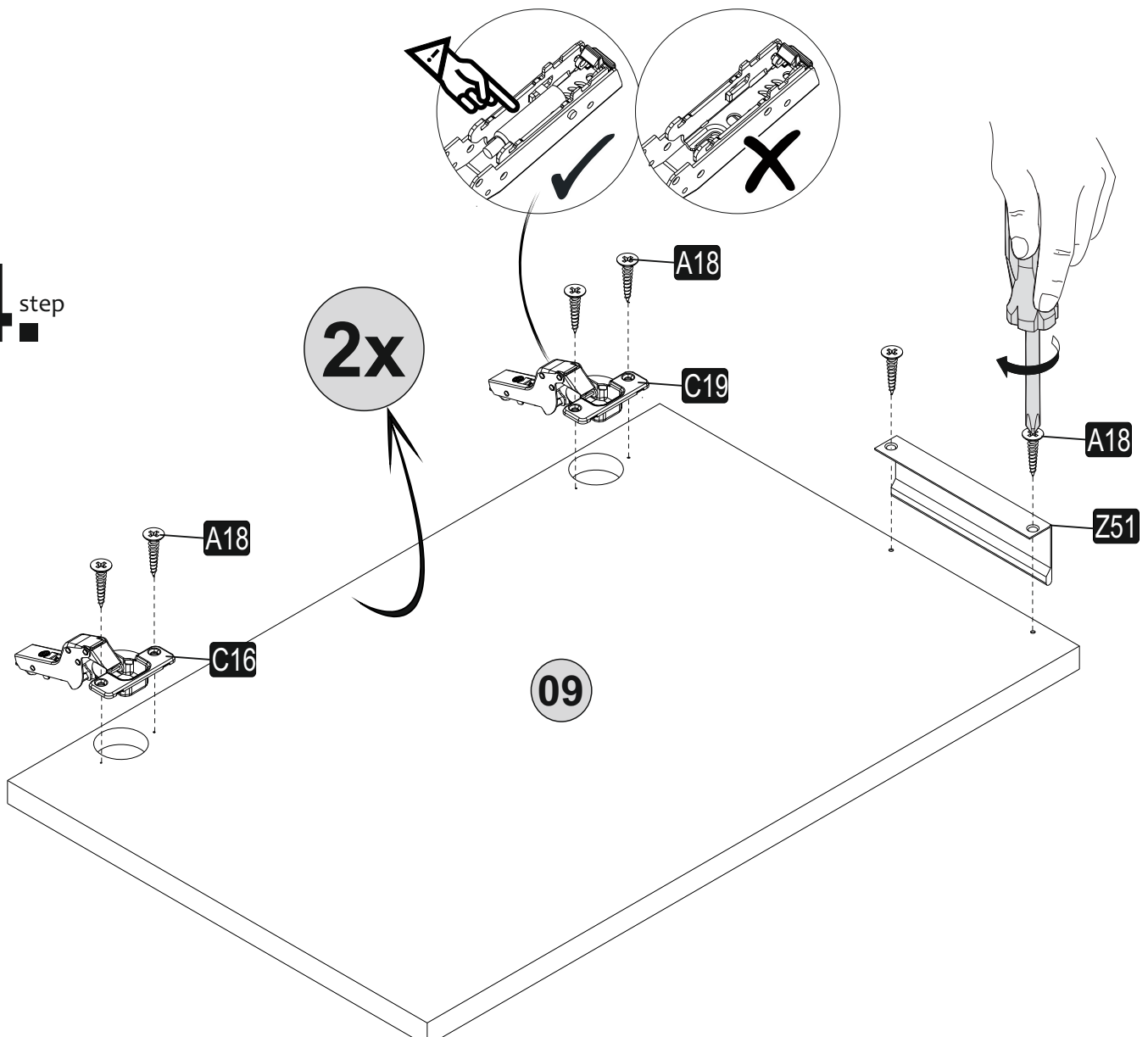

15^{step}

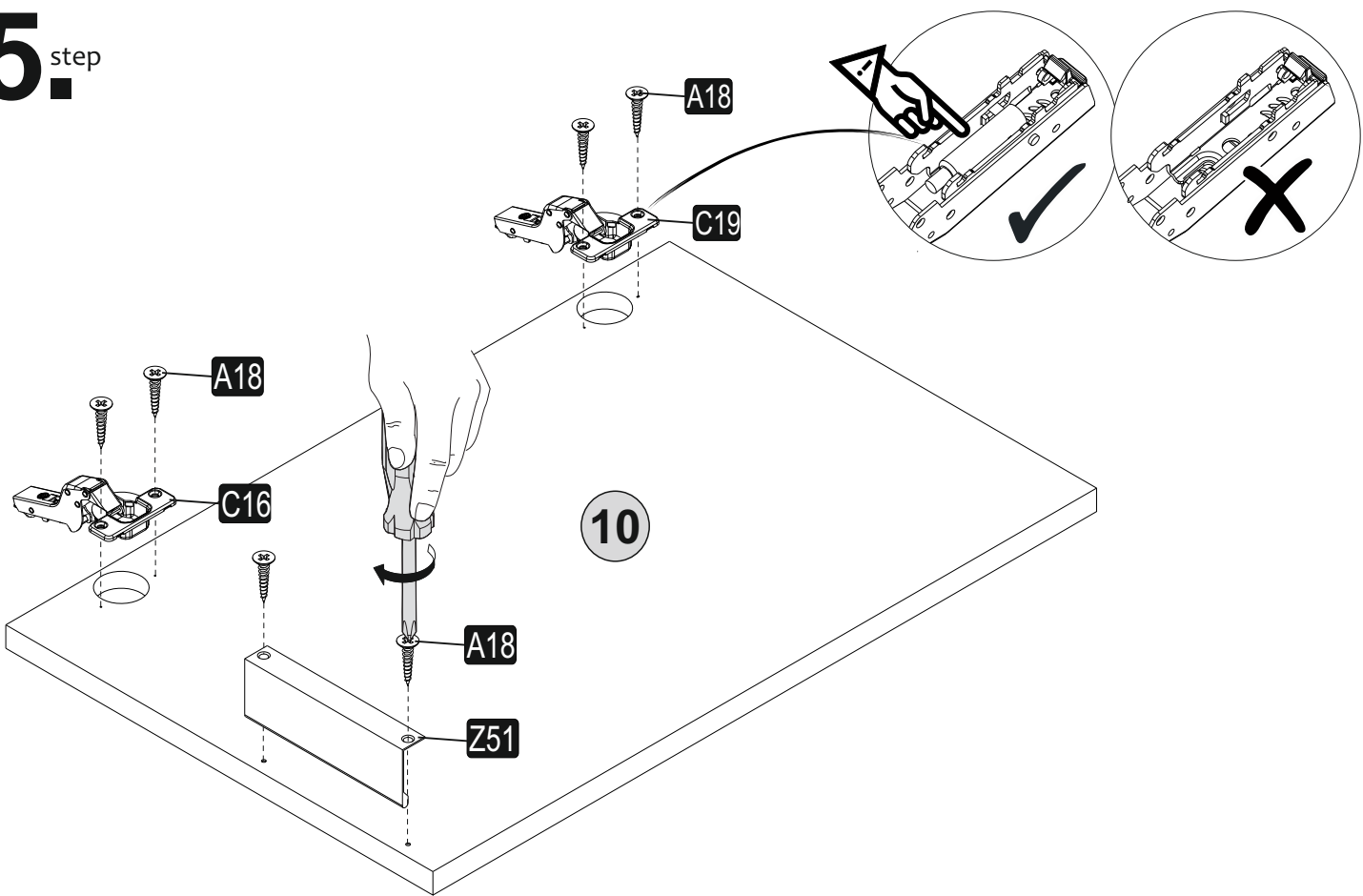

16^{step}

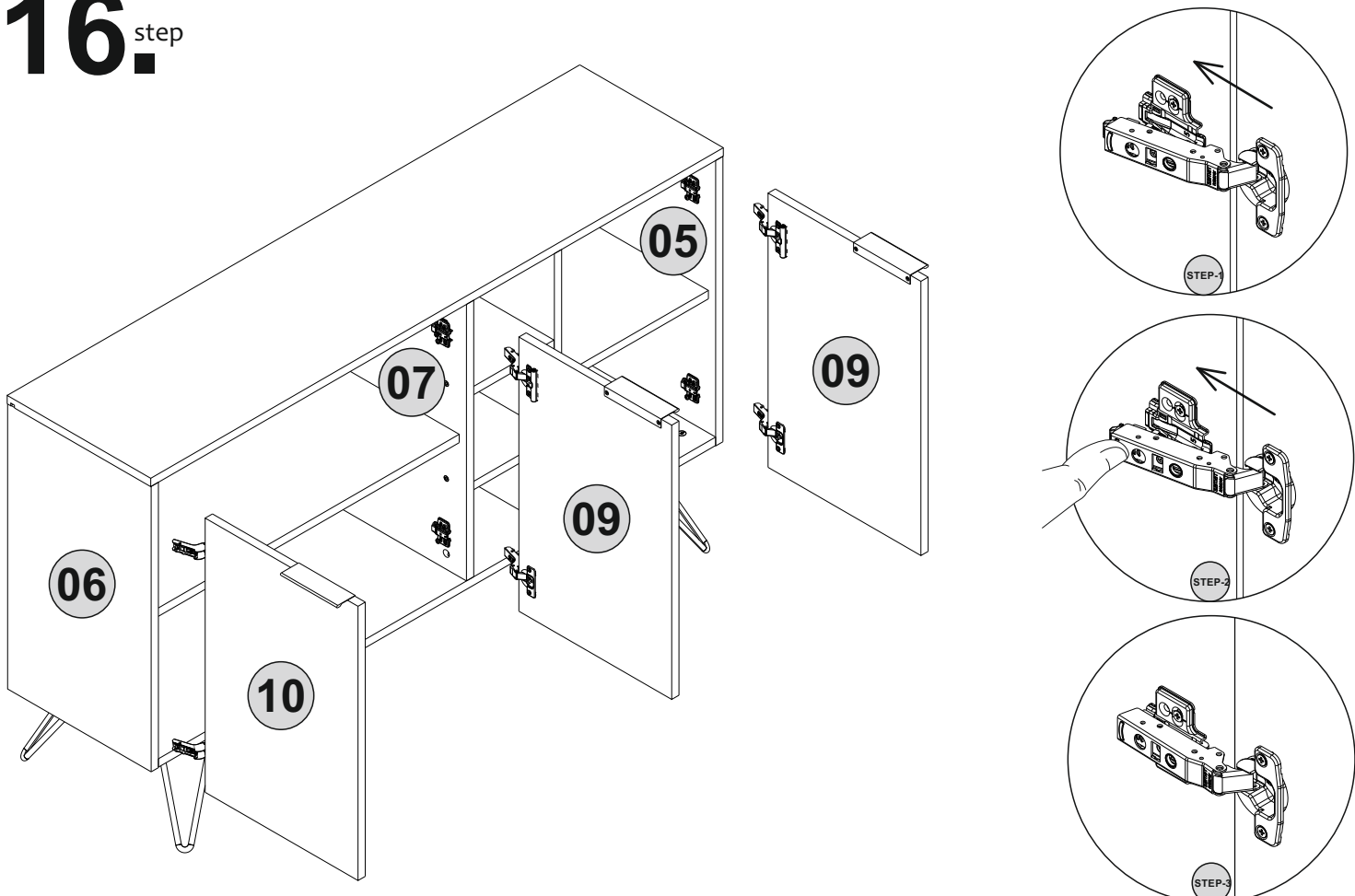

17. step

