

GP037-0001,3

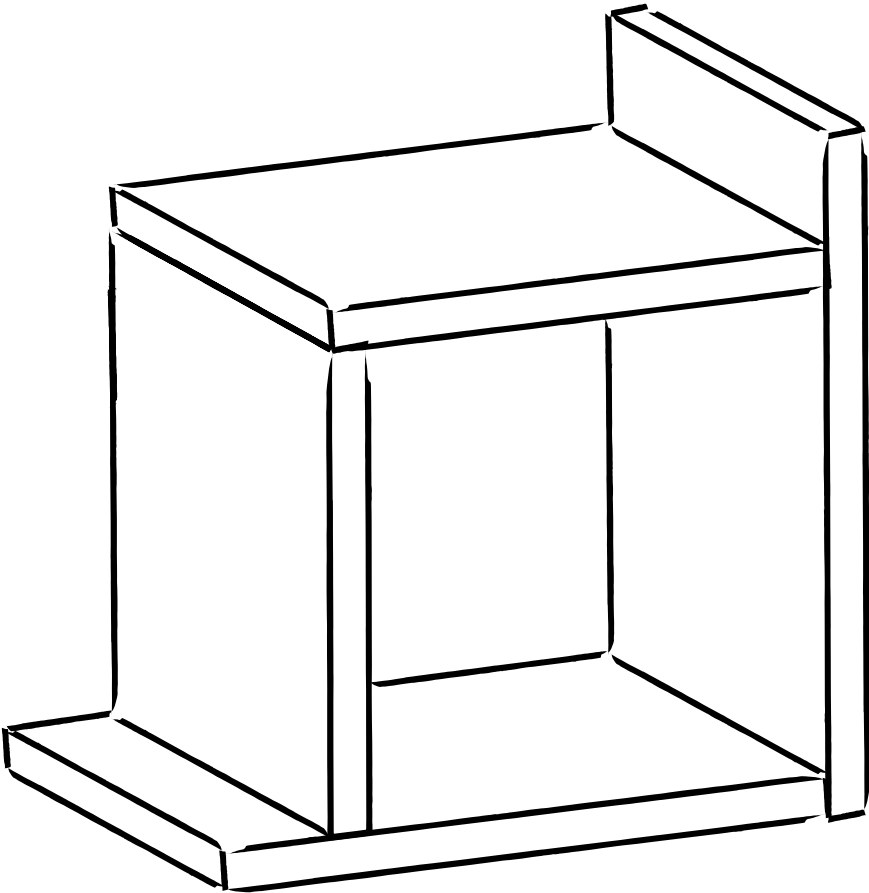

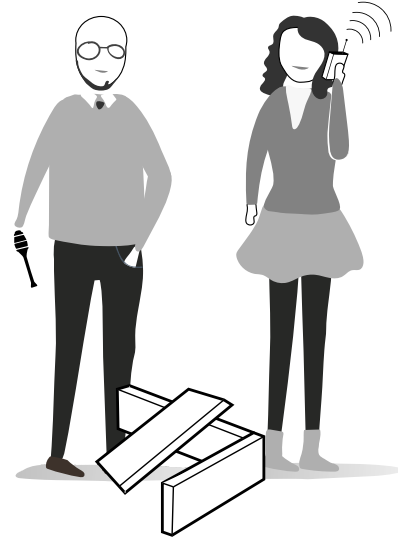
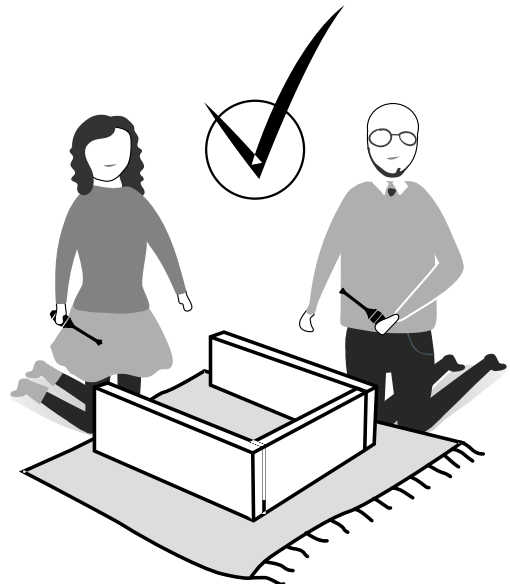
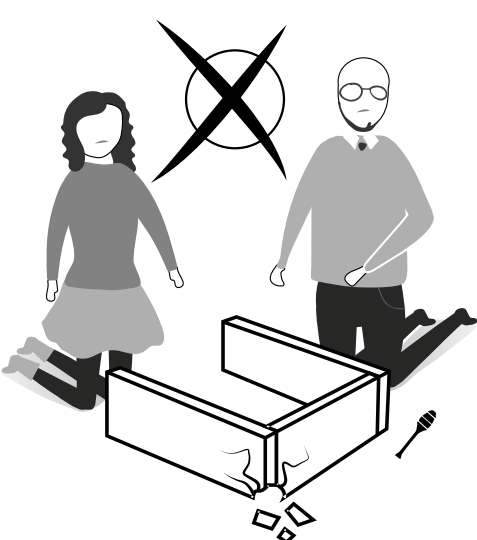
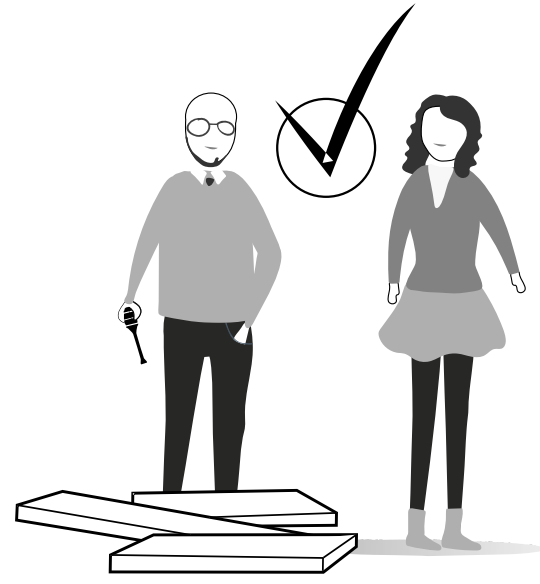
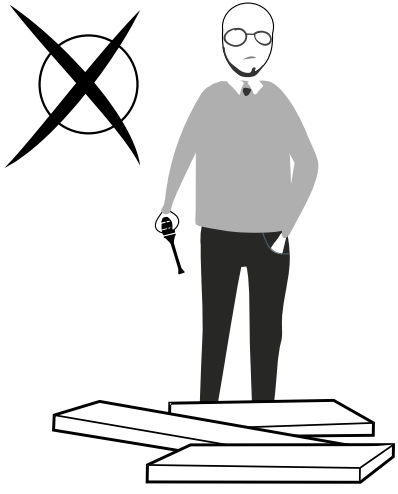

ATTENTION !!

Our products are screw system. Before you proceed with installation try to understand the following



A13



1

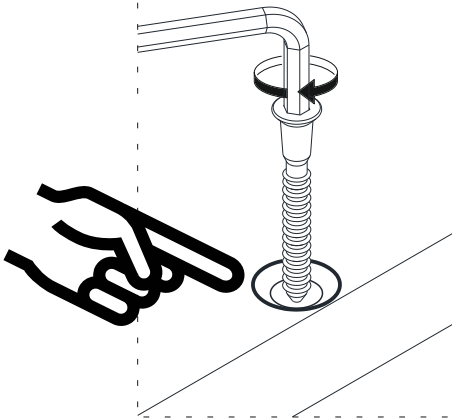

1

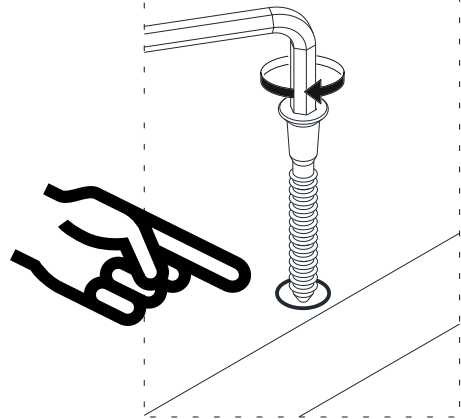

2

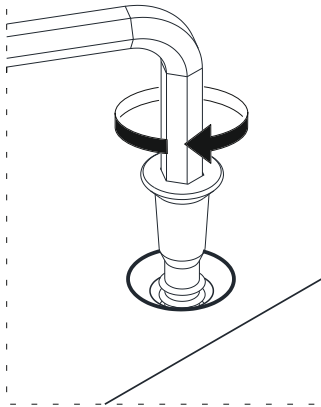

2

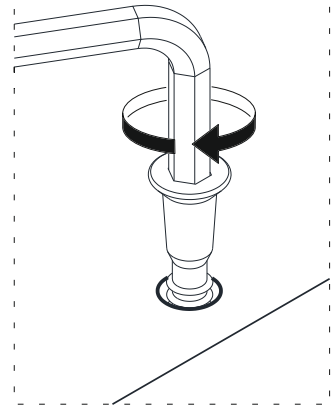

3

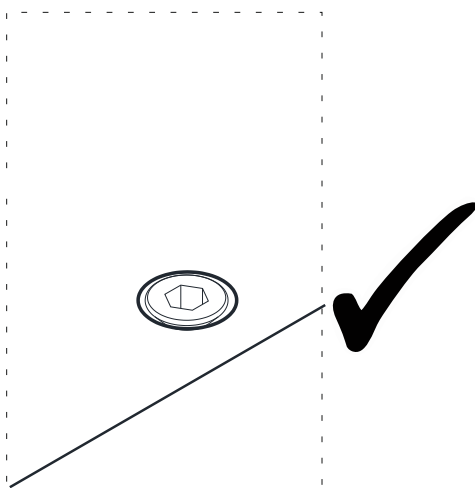



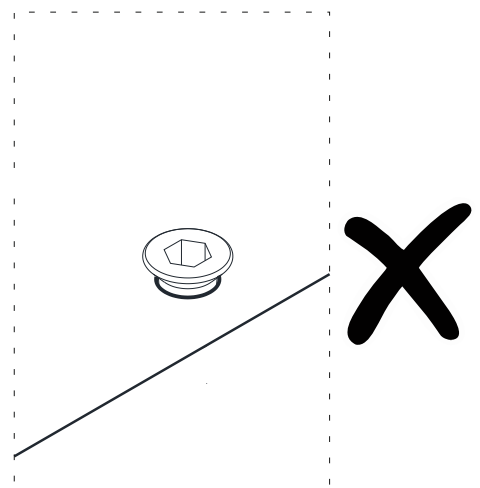



3

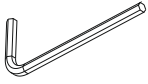

Follow the installation steps in the order as shown.
Position the parts as shown in the installation guide steps.

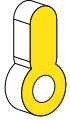
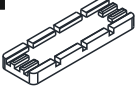
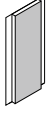
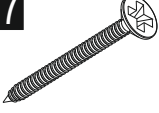

ACCESSORY LIST

A12  Allen 1x	A13  50mm 8x	A06  18mm C1-8x	A32  60/16 2x	Z18  Gbdy 2x
A08  5mm 1x	Y03  Ctpb 1x	A17  4x50 2x	A16  DbØ8 2x	A11  3,5x30 4x

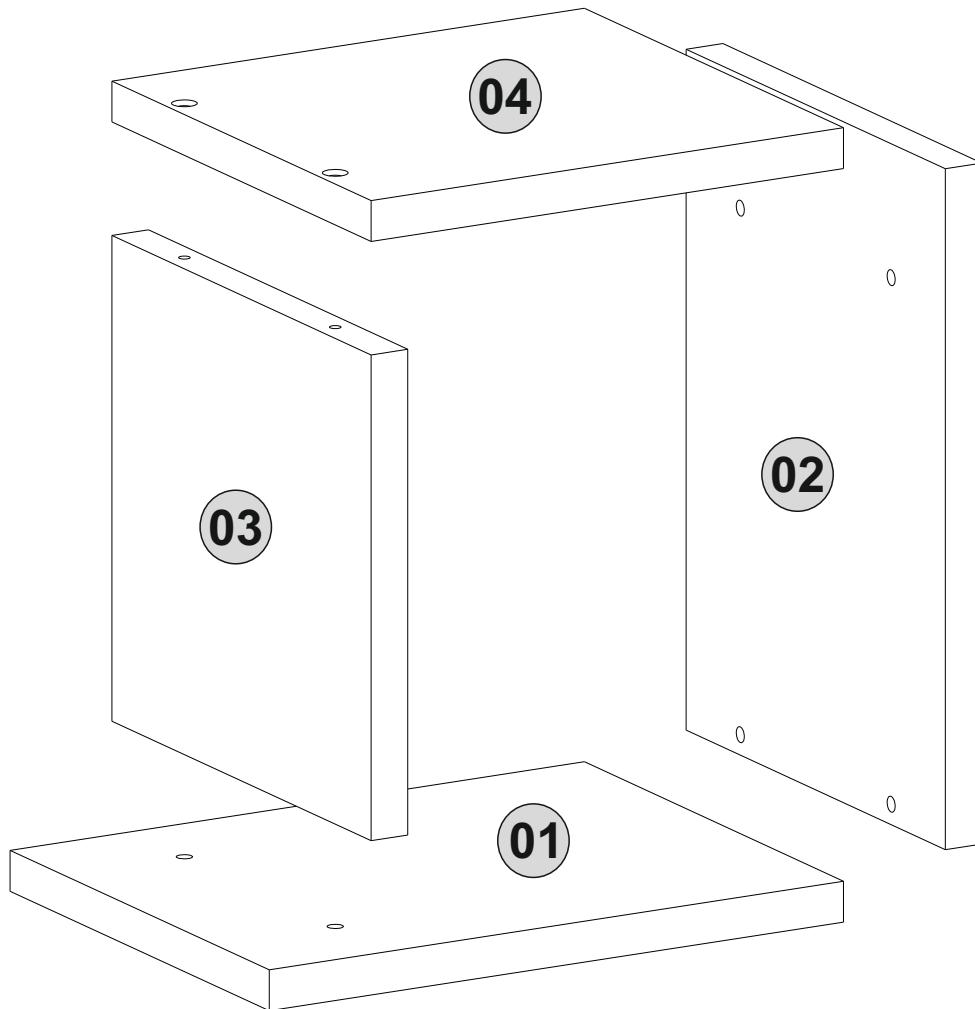

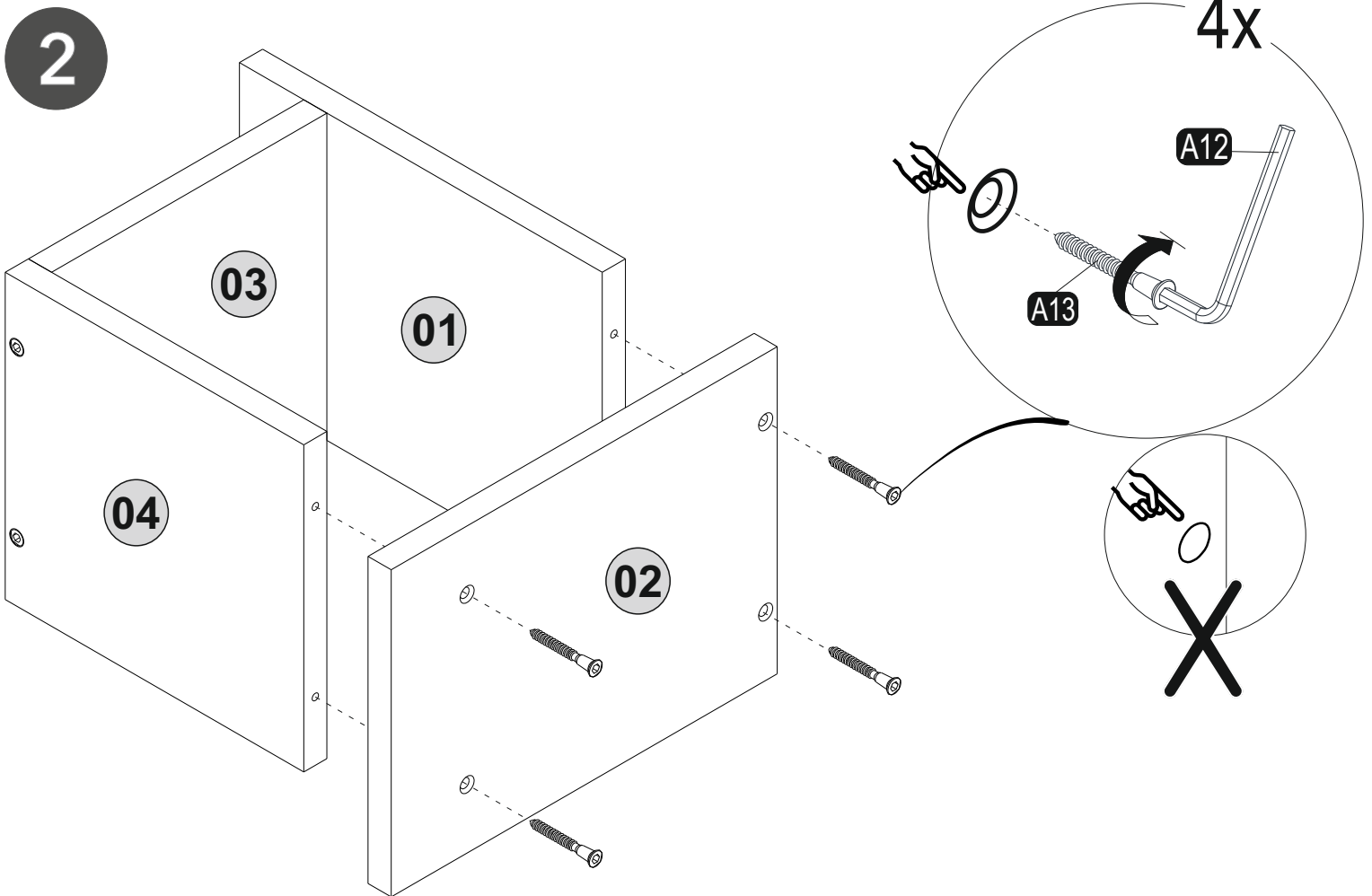
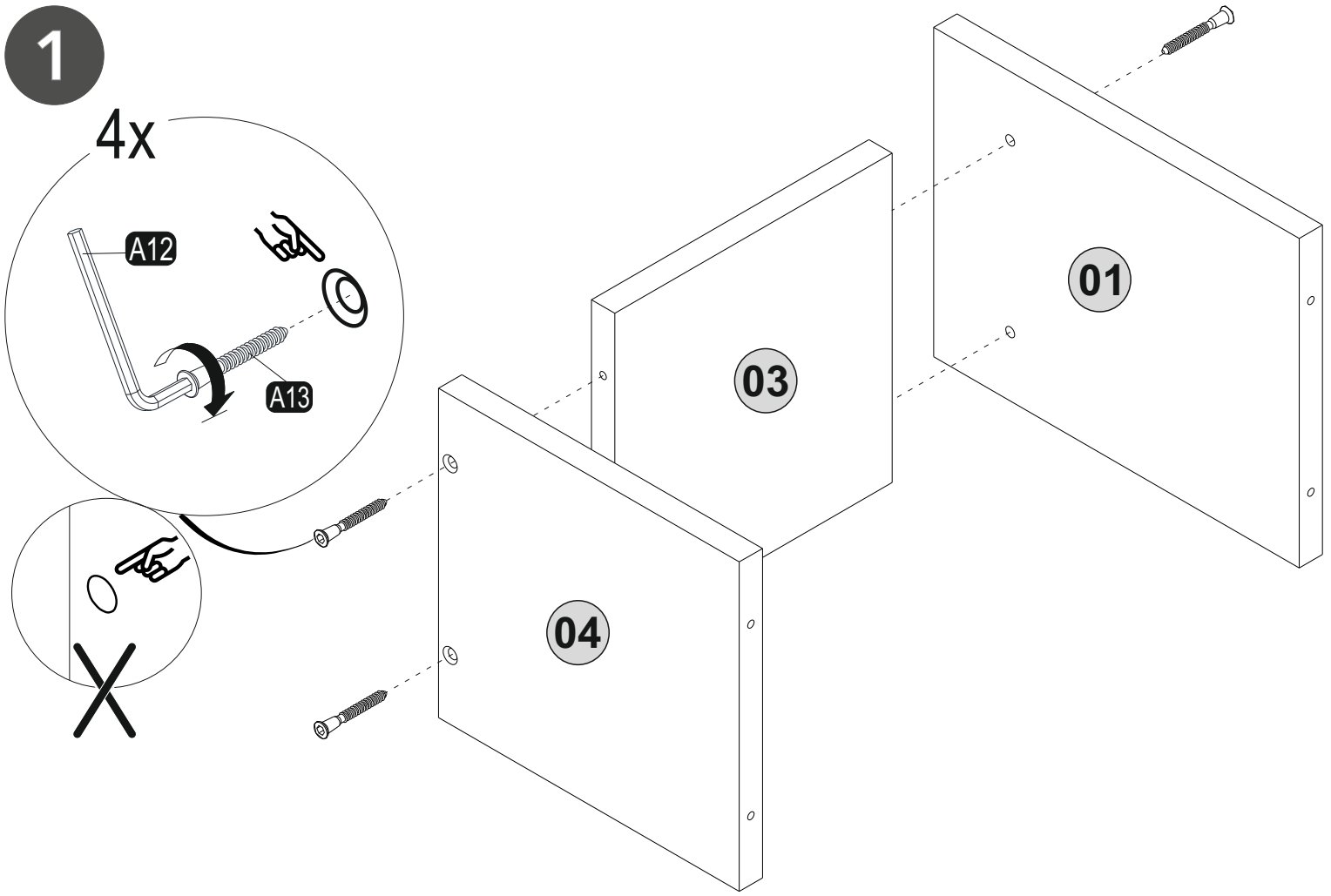

3

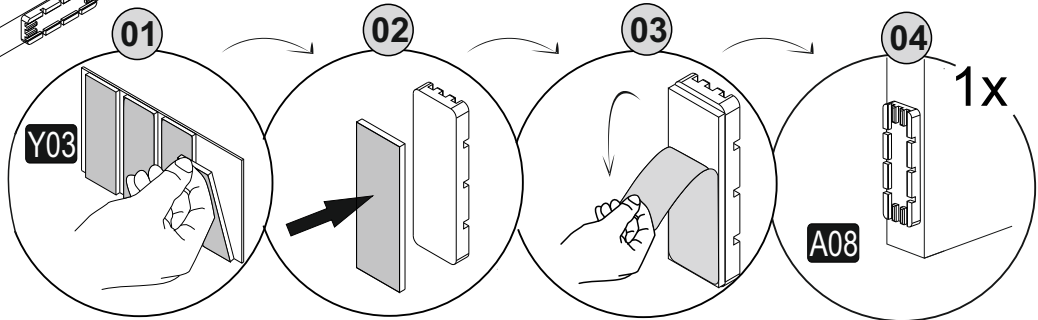
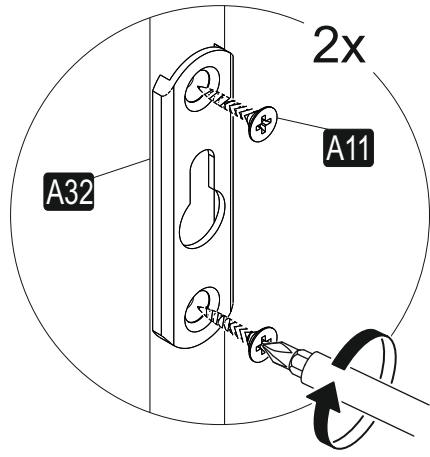
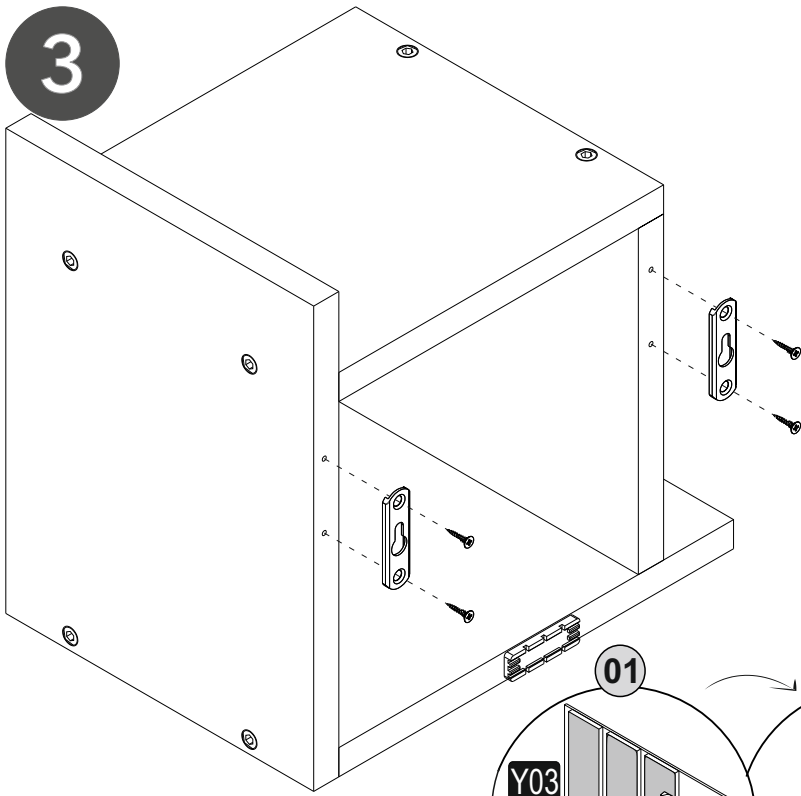

4

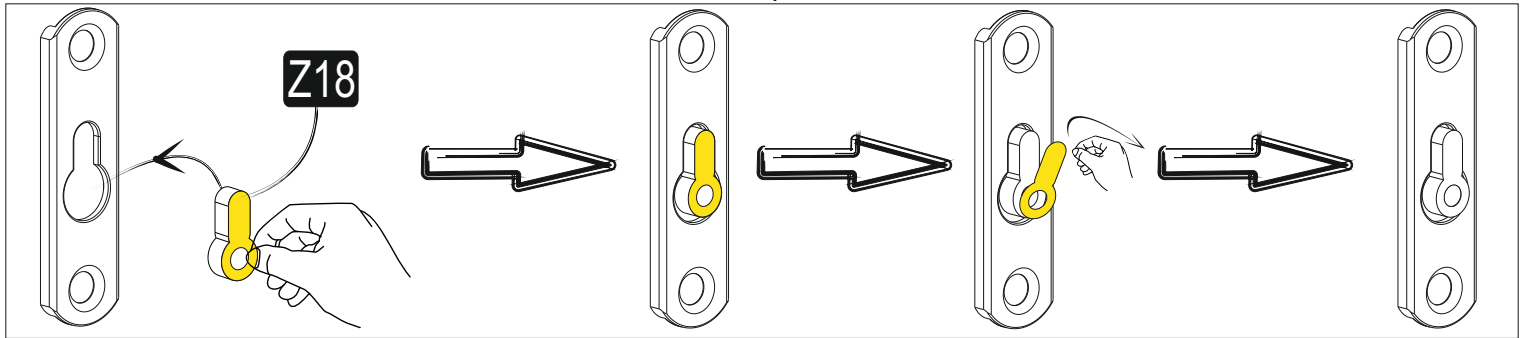
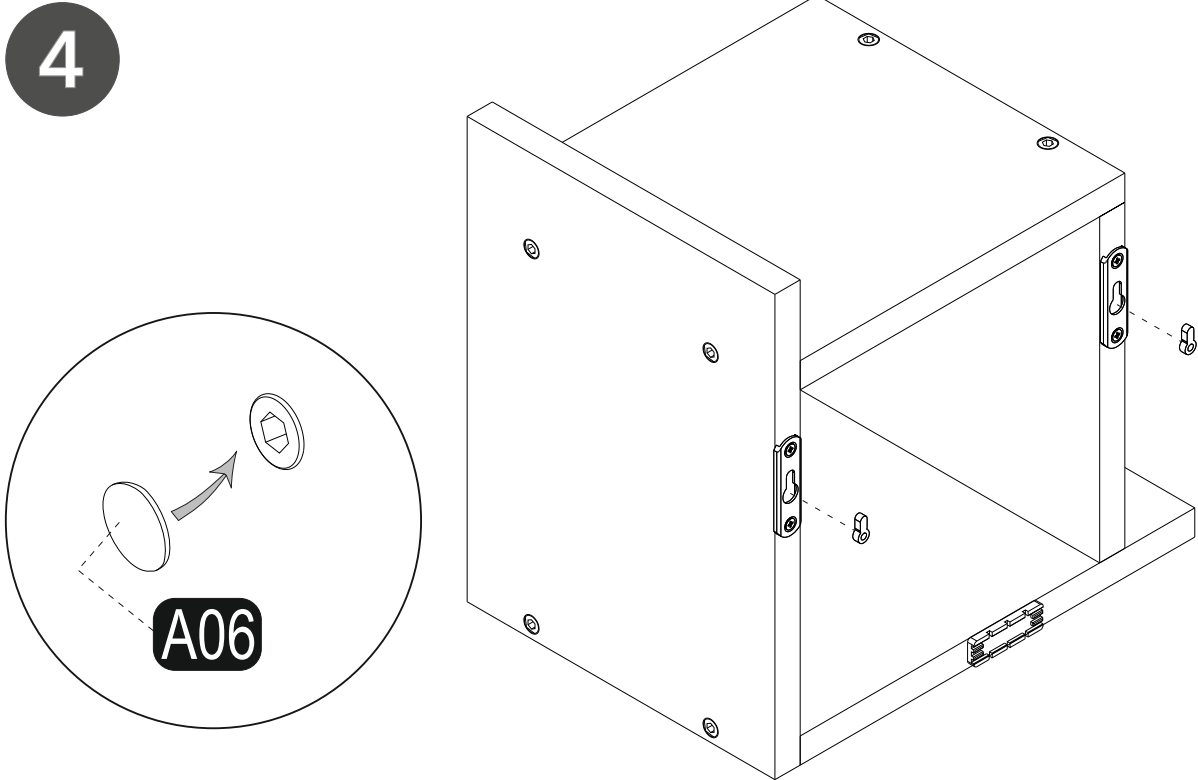

5

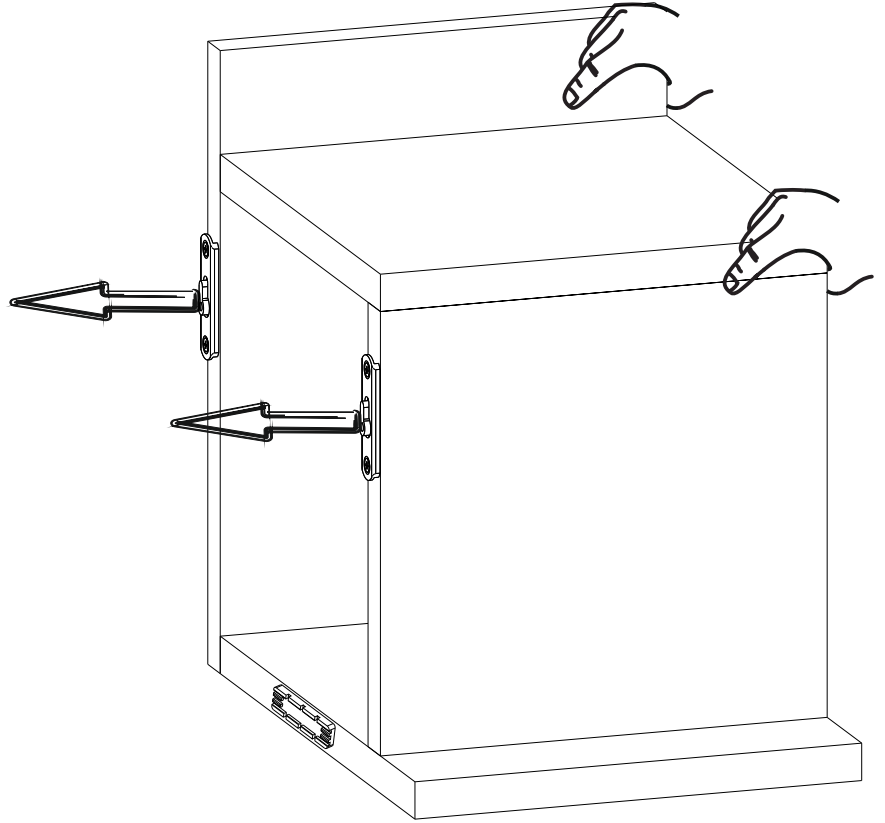
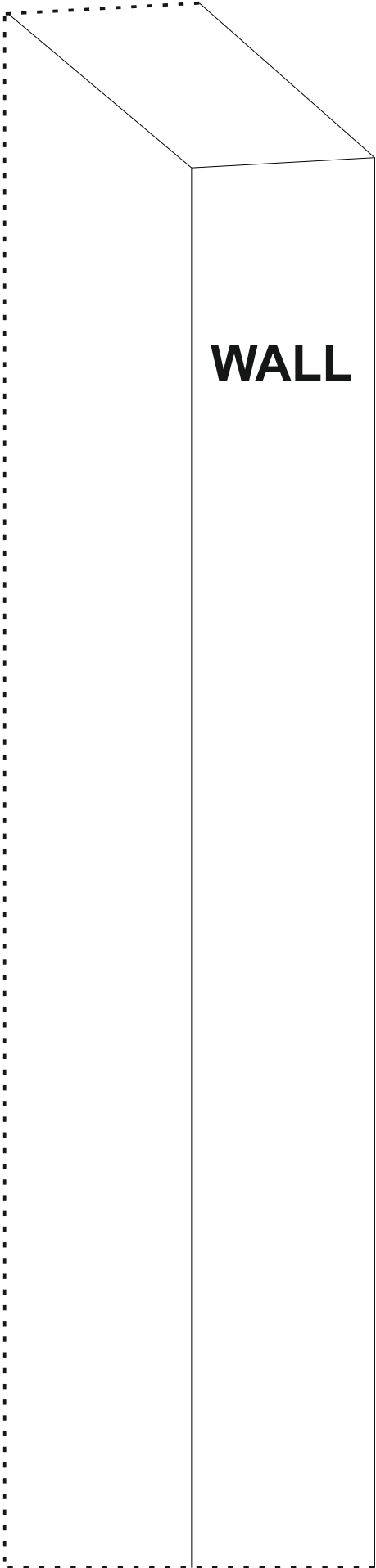

6

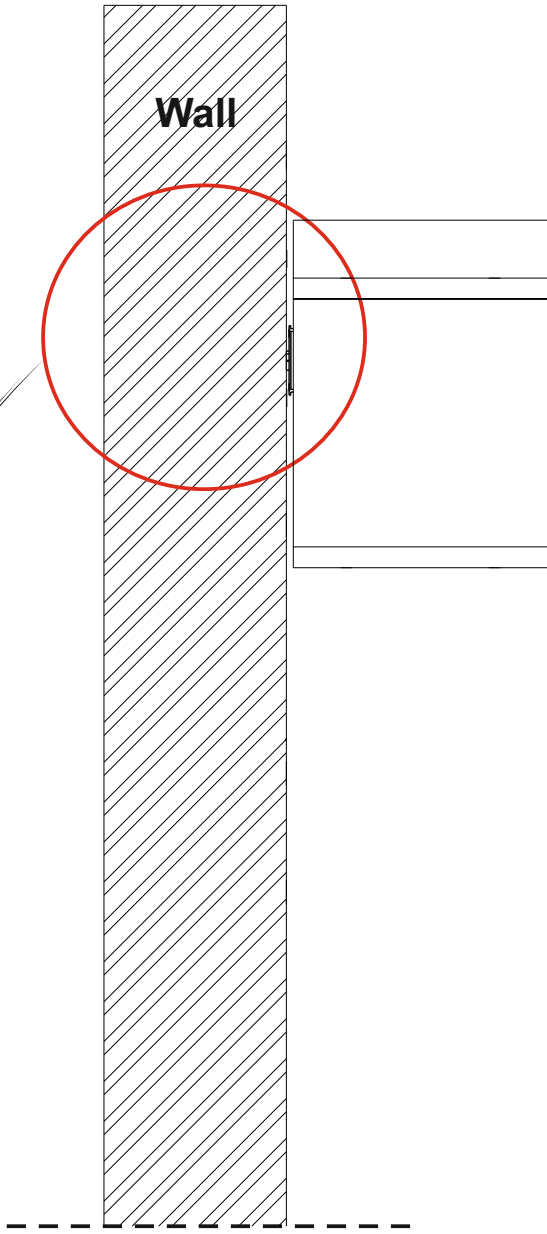

Step - 1

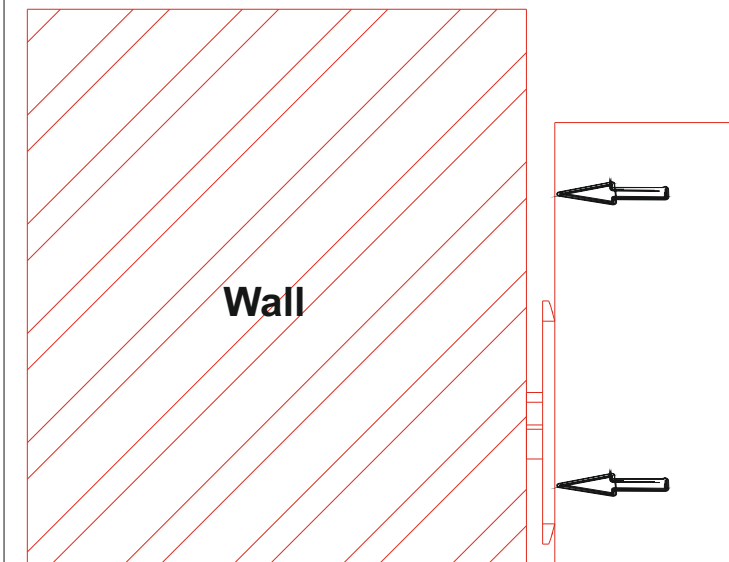

Step - 2

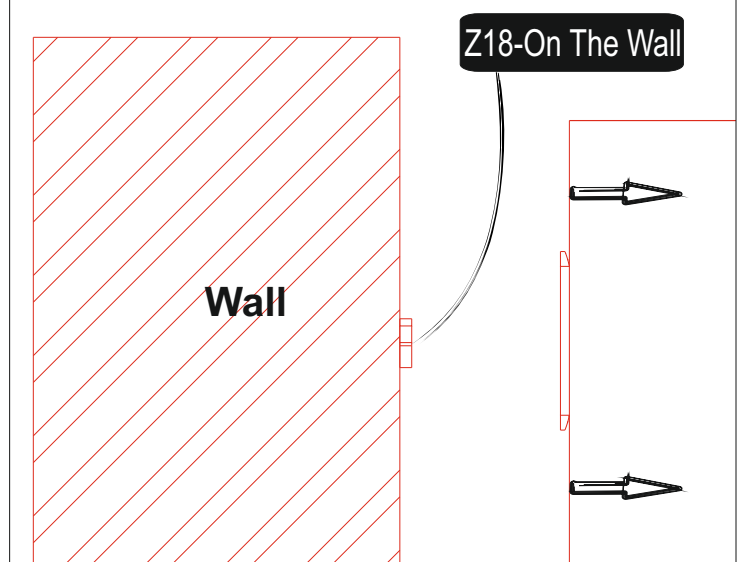

7

