

No	a*b	X	Pack
1	2284x560	1	4
2	2284x560	1	4
3	2000x580	1	3
4	1966x560	1	3
5	1966x560	1	3
6	1672x560	1	2
7	1672x560	1	2
8	1692x496	2	1
9	1246x496	1	1
10	1246x496	1	1
11	983x560	1	5
12	500x560	1	6
13	500x560	1	6
14	476x544	6	2
15	504x496	1	6
16	504x496	1	6
17	504x496	1	6
18	504x496	1	6
19	220x996	2	5
20	80x1966	1	3
21	1966x80	1	3
22	925x150	4	5
23	400x150	4	1
24	100x400	2	2
25	2216x498	4	4
26	957x400	2	4

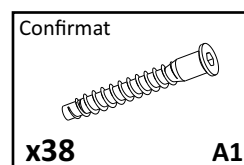

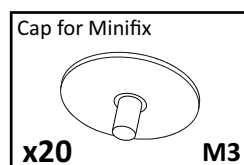
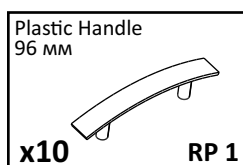
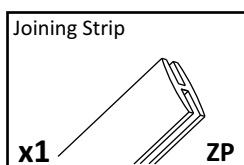
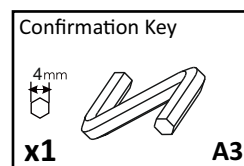
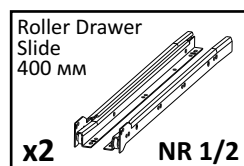
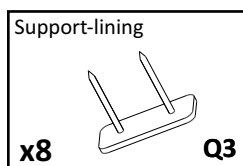
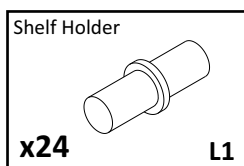
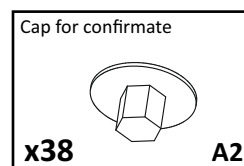
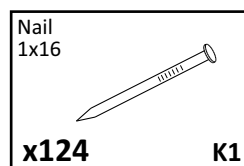
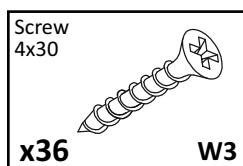
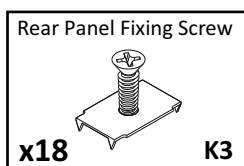
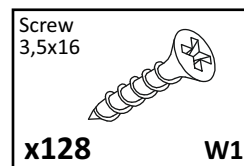
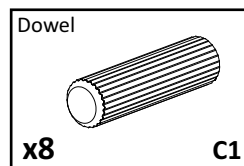
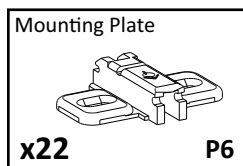
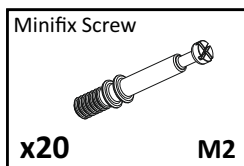
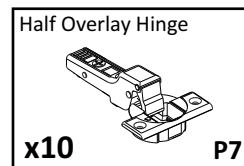
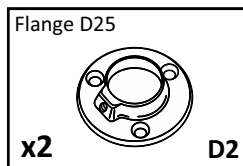
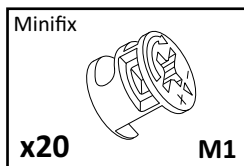
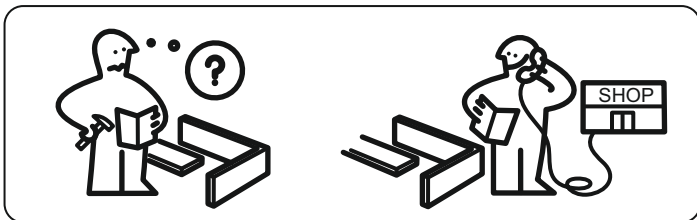
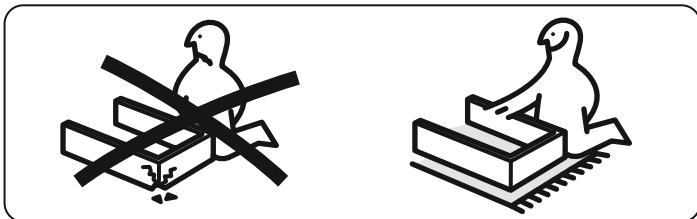
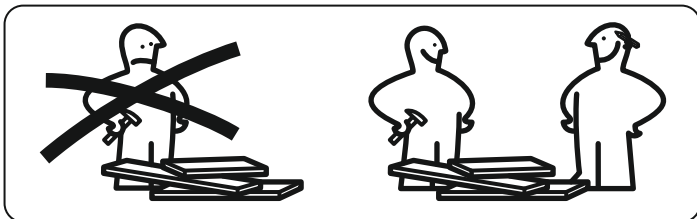

GENERAL TECHNICAL INSTRUCTIONS FOR FURNITURE ASSEMBLY

- CHECK COMPATIBILITY OF PARTS AND ACCESSORIES BEFORE ASSEMBLY.
- FOR FURNITURE ASSEMBLY, WE RECOMMEND USING THE SERVICES OF QUALIFIED SPECIALISTS.
- DO ASSEMBLY ON A SURFACE COVERED WITH CLOTH OR CARDBOARD TO PREVENT SCRATCHES.

CARE AND MAINTENANCE OF FURNITURE

- KEEP THE FURNITURE FROM PROLONGED CONTACT WITH WATER OR HOT STEAM.
- ENSURE SUFFICIENT DISTANCE FROM ELECTRICAL APPLIANCES AND HEATERS.
- IF THERE IS DIRTY ON THE FURNITURE, REMOVE IT WITH A DAMP CLOTH AND THEN WIPE IT DRY. DO NOT USE ABRASIVE MATERIALS.

1

Mounting Plate

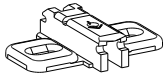

x22

P6

Roller Drawer Slide
400 mm

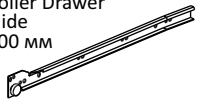

x2

NR 1

Minifix



x20

M1

Screw
3,5x16

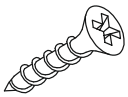

x52

W1

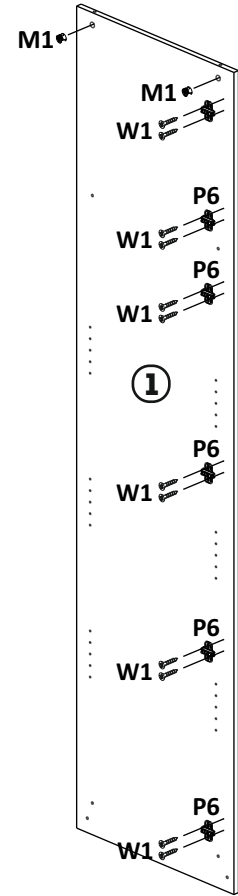
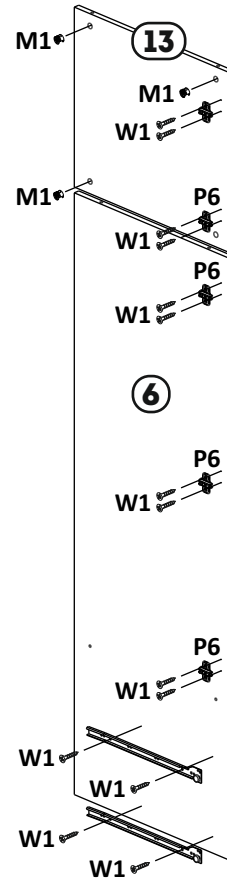
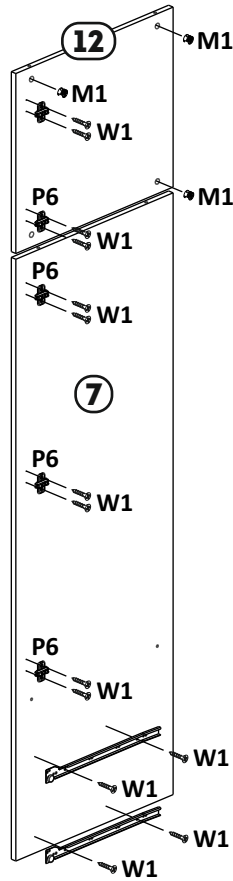
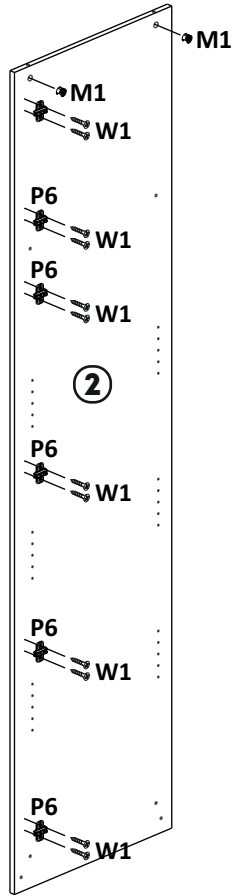
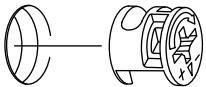

2

Confirmat

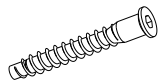

x6

A1

Minifix Screw

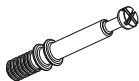

x4

M2

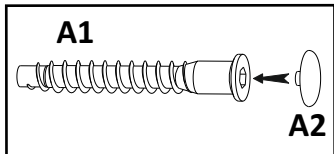
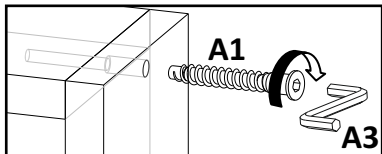
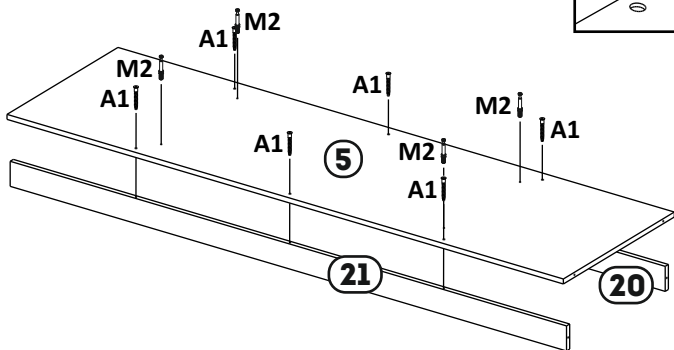
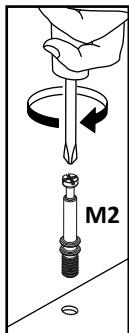
**3**

Confirmat

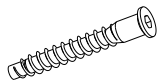

x8

A1

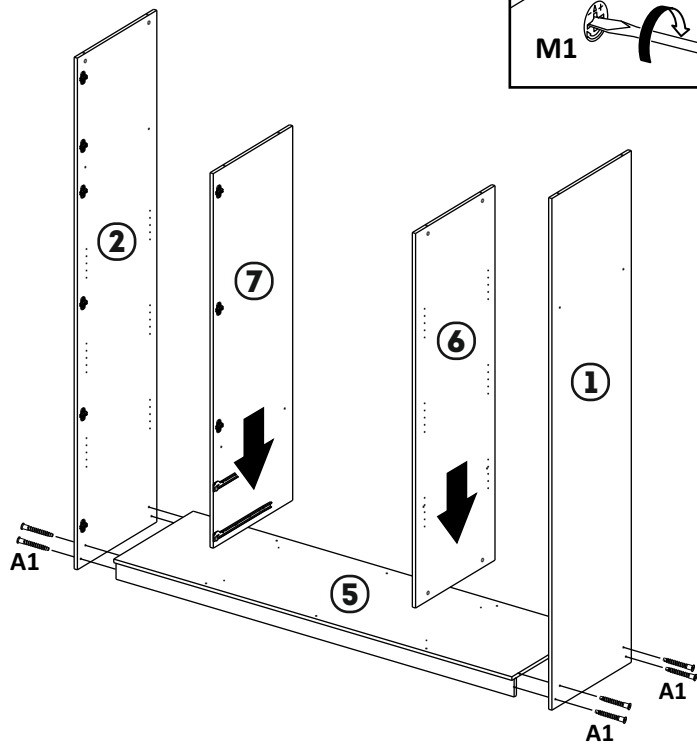
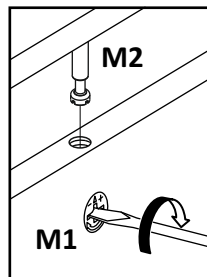

4

Minifix Screw

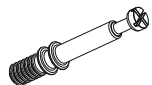

x8

M2

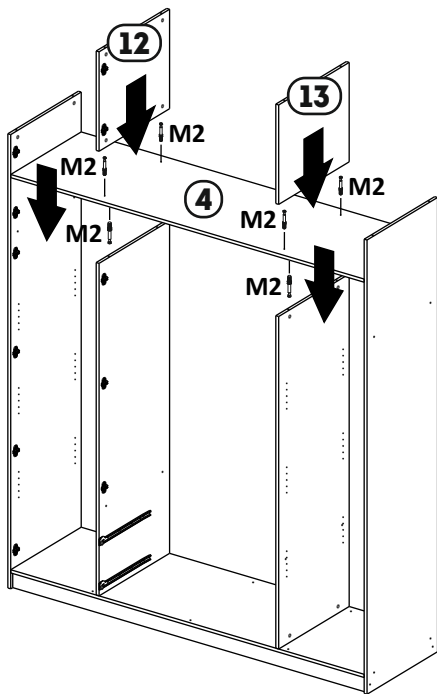
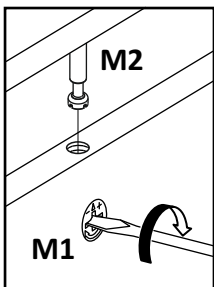

5

Minifix Screw

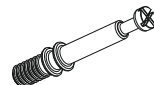

x8

M2

Confirmat

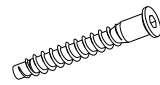

x8

A1

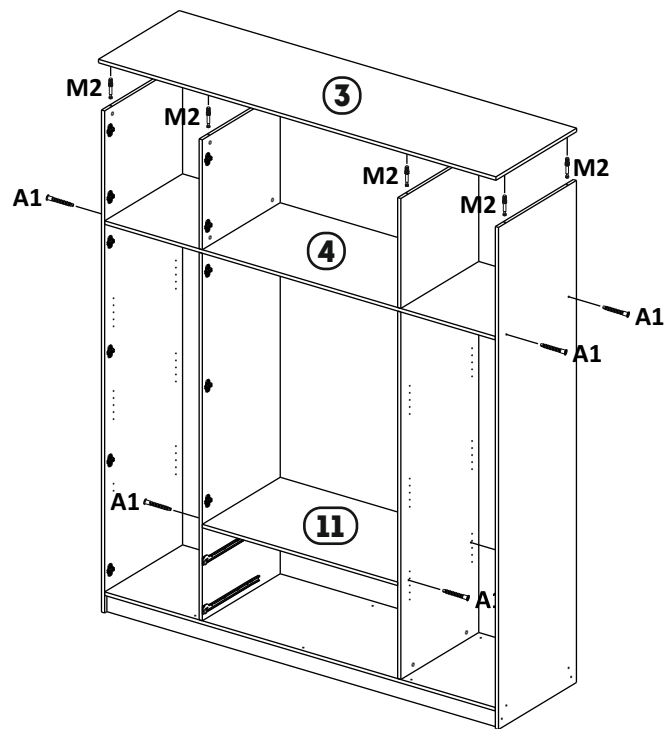

6

Rear Panel Fixing Screw

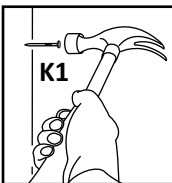
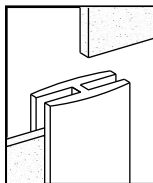
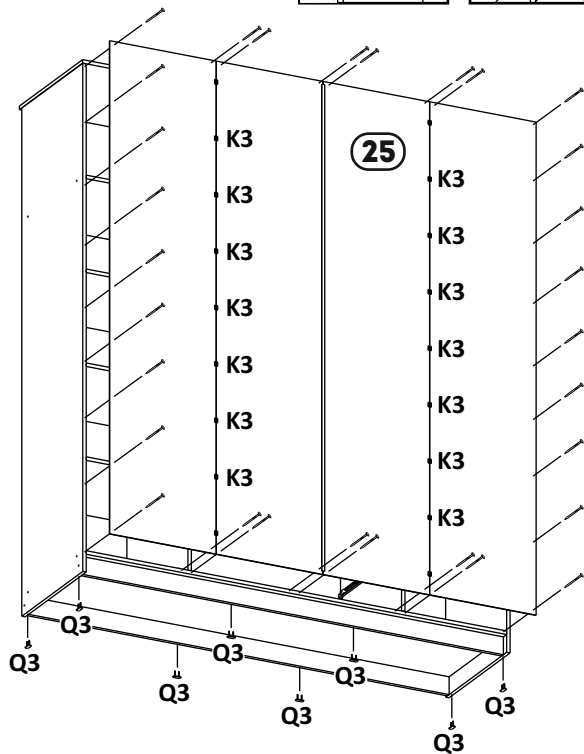
**x18****K3****K1****7**

Confirmat

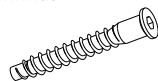
**x8****A1**

Cap for confirmate

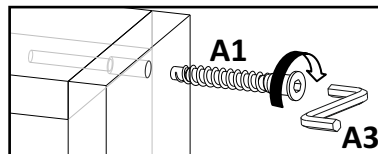
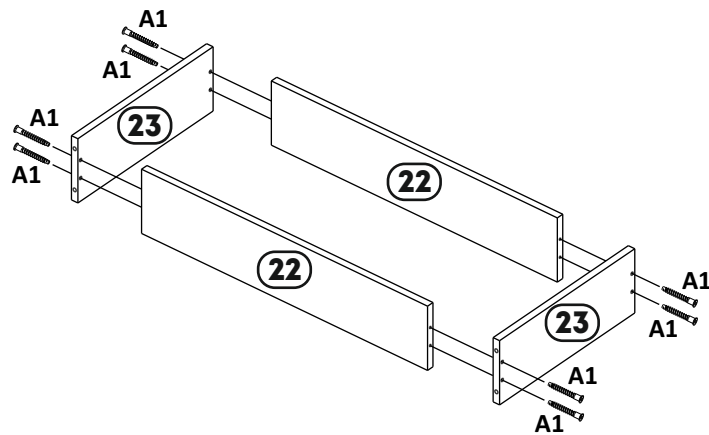
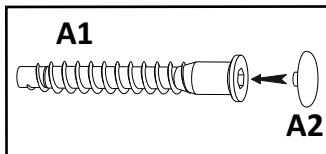
**x8****A2****A1****A2****A3****A1****A2****8**

8

Screw
4x30

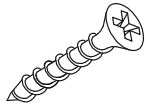

x4

W3

Plastic Handle
96 mm



x2

RP 1

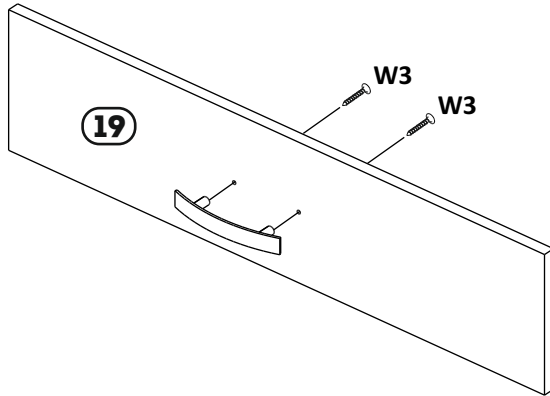

9

Dowel

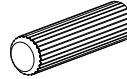

x4

C1

Nail
1x16

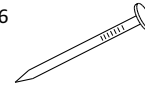

x26

K1

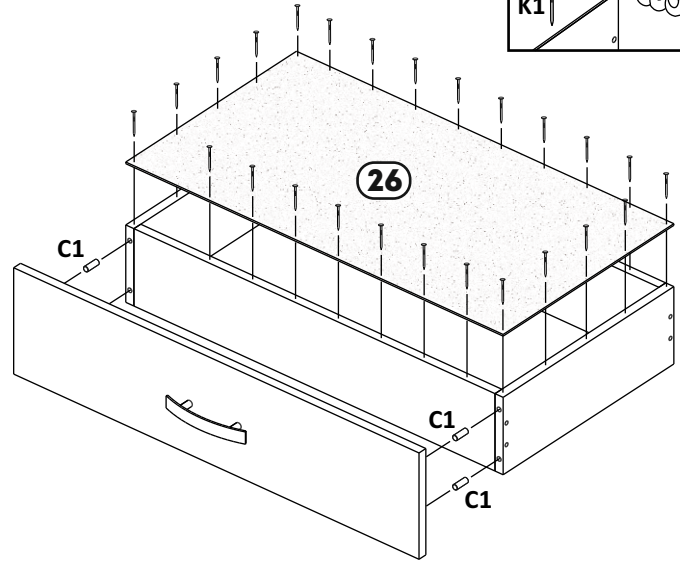
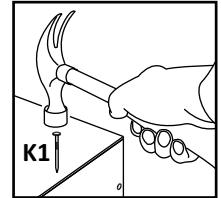

10

Roller Drawer
Slide
400 mm

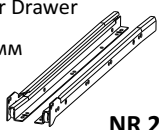

x1

NR 2

Screw
3,5x16

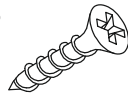

x4

W1

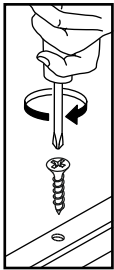
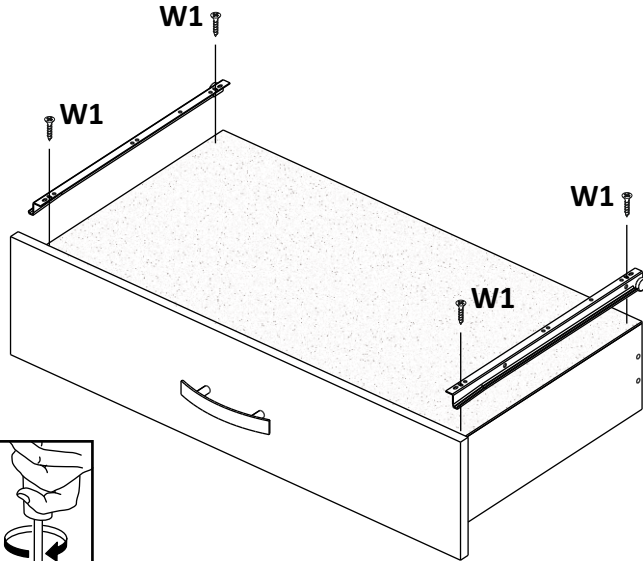

11

Screw
4x30

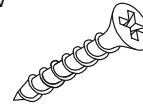

x4

W3

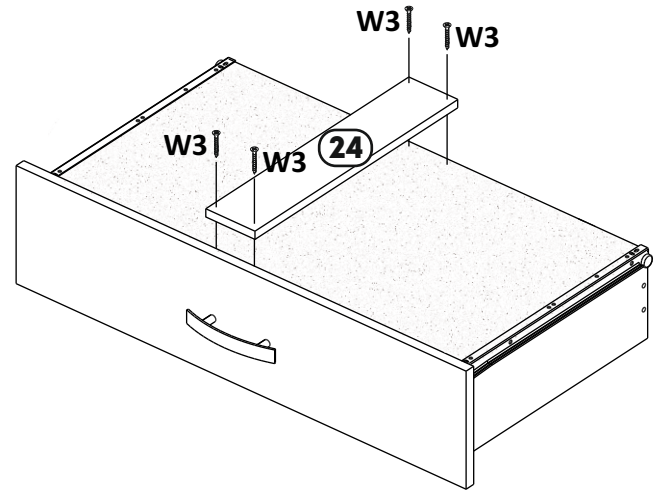

12

Screw
3,5x30

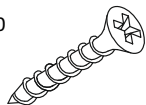

x4

W3

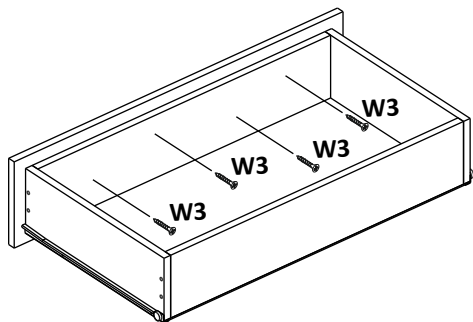

13

Full Overlay Hinge

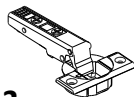

x12

P5

Half Overlay Hinge

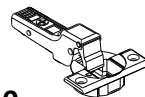

x10

P7

Screw
3,5x16

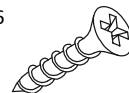

x44

W1

