

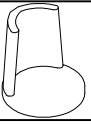

INSTALLATION INSTRUCTION



266-000006



PART LIST

NO.	DESCRIPTION	PART	QTY
Ⓐ	CHAIR TOP		Ⓛ
Ⓑ	LEG		4
Ⓒ	SUPPORT PART		Ⓛ

MATERIALS LIST

NO.	METARIALS	QTY	
Ⓐ		8	
Ⓑ		4	



First screw the legs to the support part.

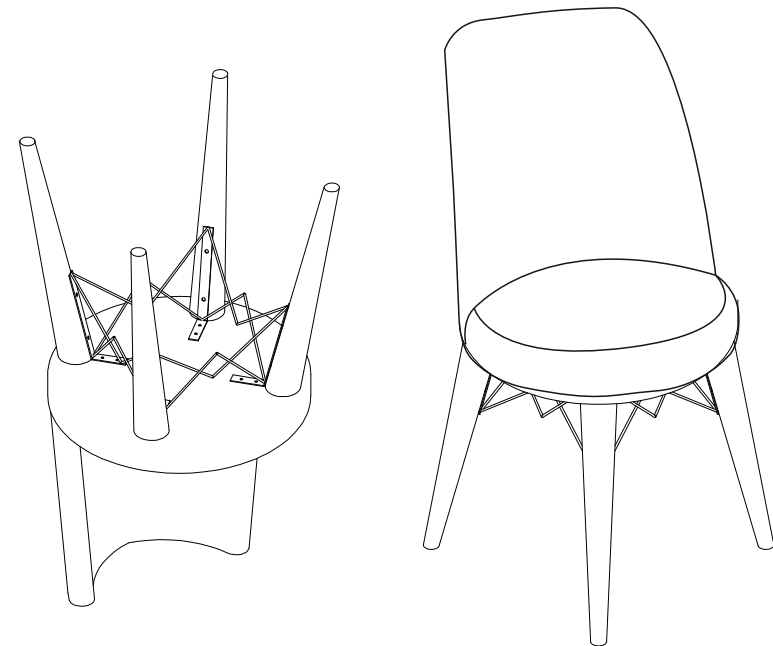
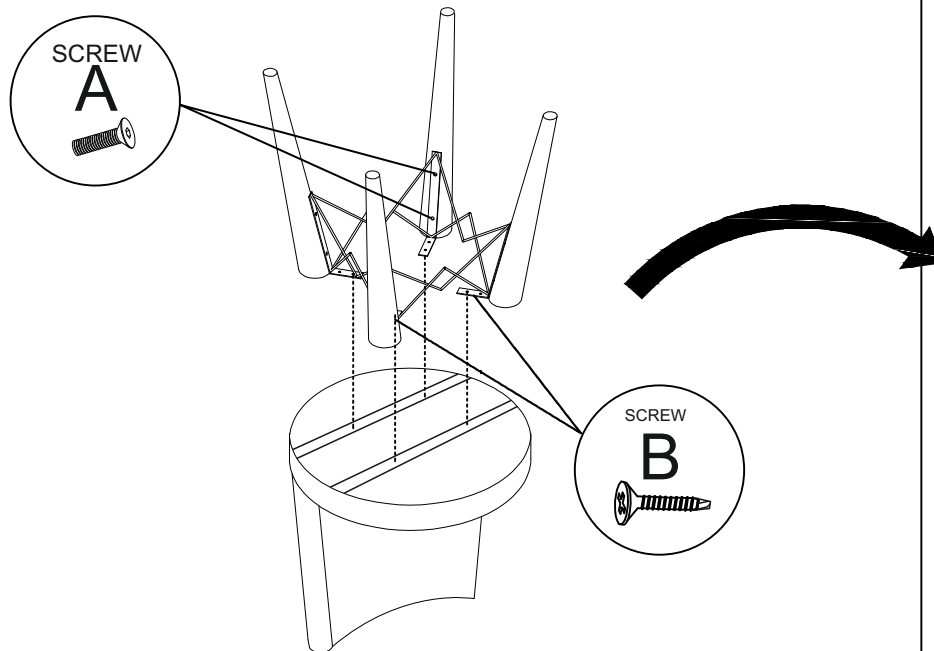

Secondly screw the legs to the chair as shown.

Please Be Careful When You Using Screwdriver!