

249-000030

Assembly Instruction

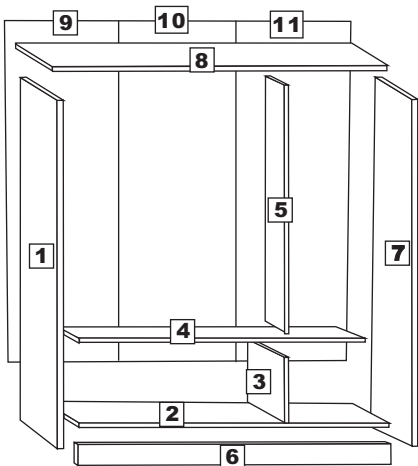

STEP 1

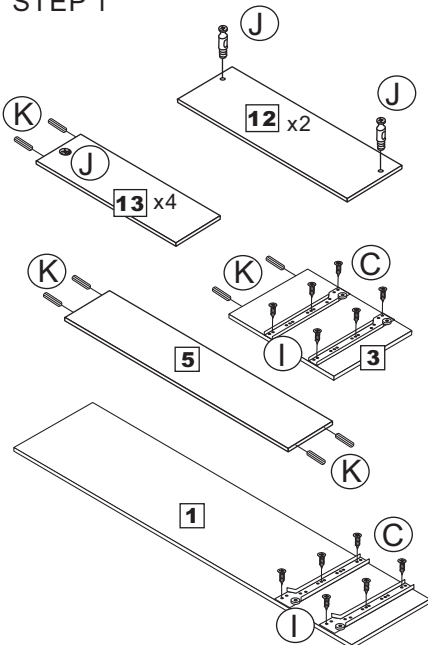

STEP 2

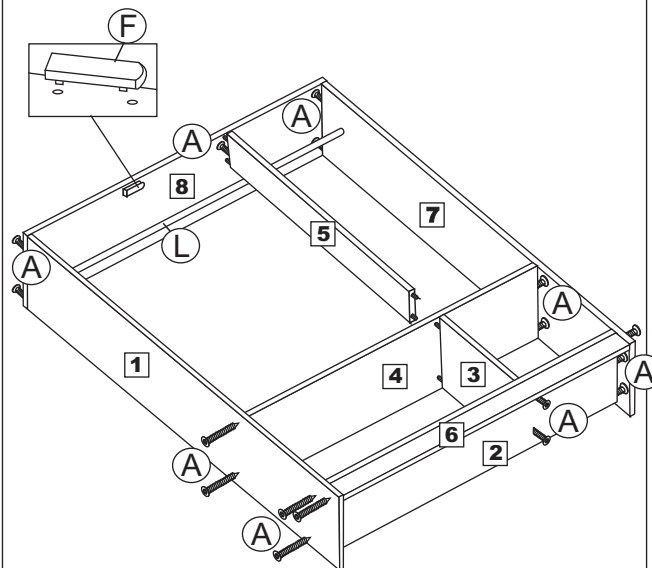

STEP 3

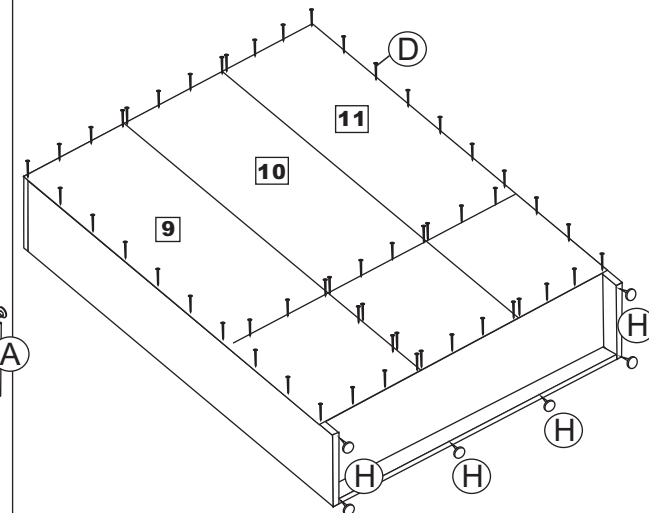

NO	HARDWARE LIST	QTY
A	JCBC screw M6X40MM	17
B	M4X25MM screw	10
C	M3.5X14MM screw	56
D	Nail	70
E	Handle	5
F	Drawer Stopper	2
G	Hinge	9 sets
H	Leg Pin	6
I	Drawer Slide 12'	2 sets
J	Mini Fit	4 sets
K	Dowel	14
L	Pipe	1
M	M4X32MM screw	8
N	Allen Key	1

STEP 3

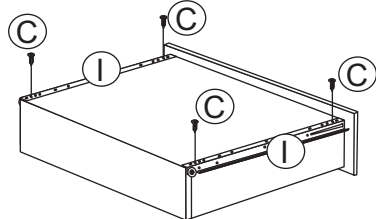
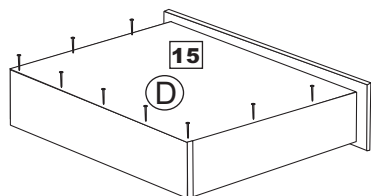
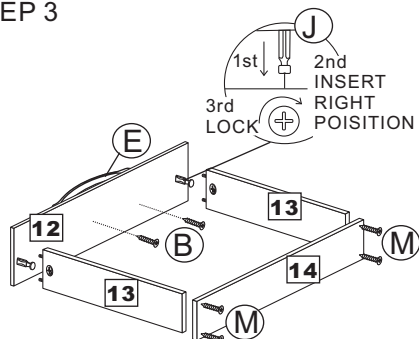

x2

STEP 4

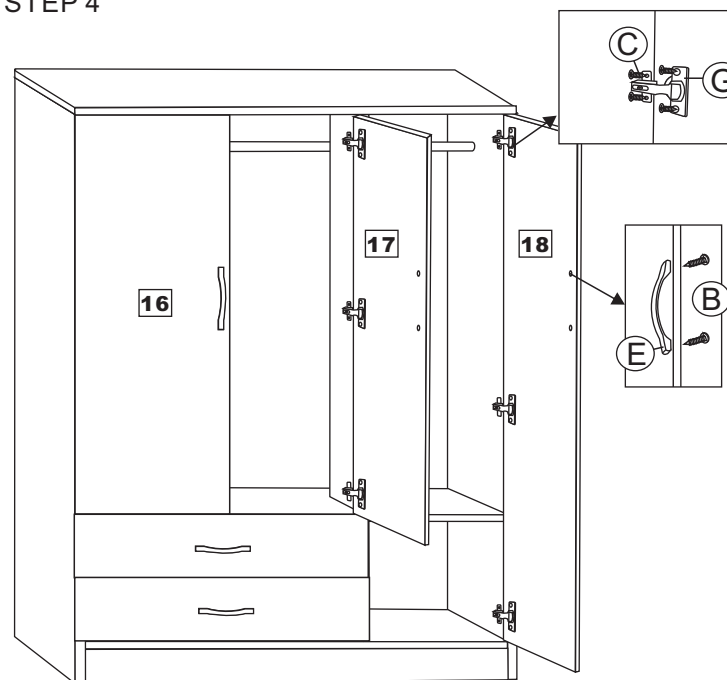

COMPLETE

