

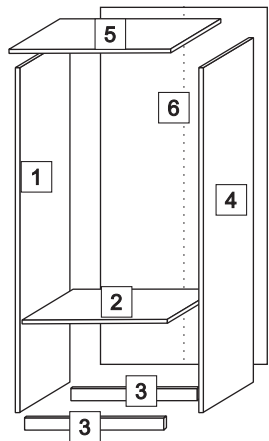













249-000008
Assembly Instruction



NO	HARDWARE LIST	QTY
A	JCBC screw M6X40MM 	12
B	M4X32MM screw 	8
C	M4X25MM screw 	8
D	M3.5X14MM screw 	48
E	Nail 	56
F	Dowel 8x25mm 	8
G	Mini Fit 	4 sets
H	Handle 	4
I	Leg Pin 	4
J	Drawer Stopper 	1
K	Hinge 	6
L	Drawer Slide 12" 	2 sets
M	Pipe 	1
N	Allen Key 	1

STEP 1

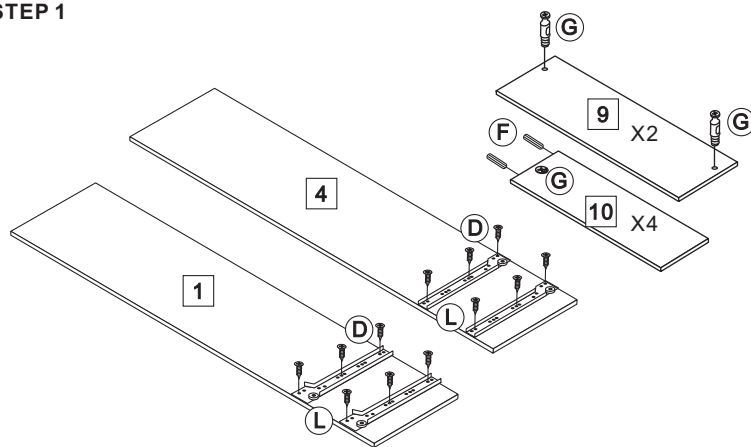

STEP 2

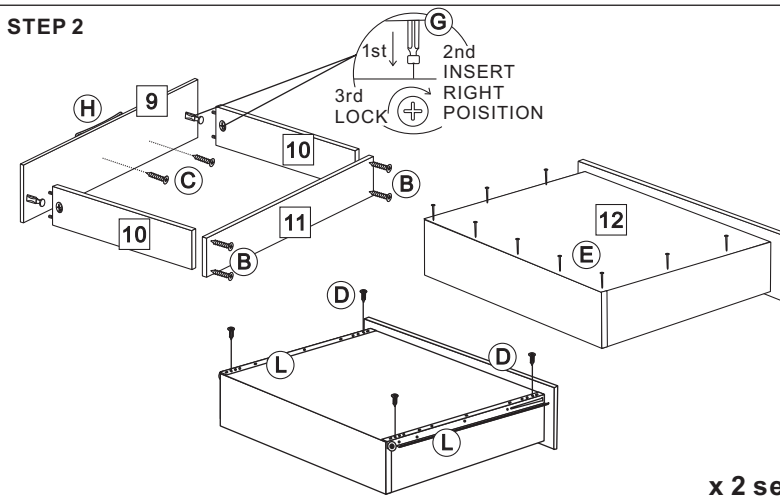

x 2 sets

STEP 3

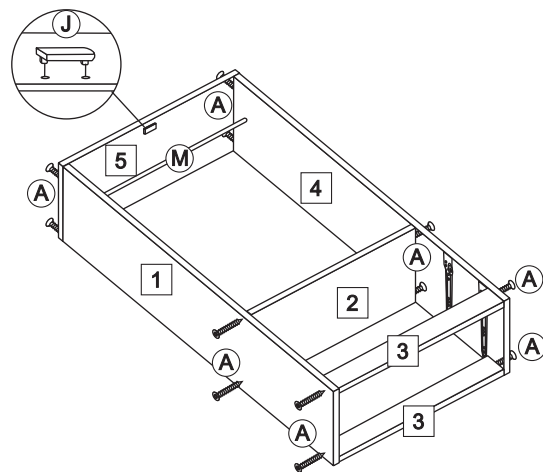

STEP 4

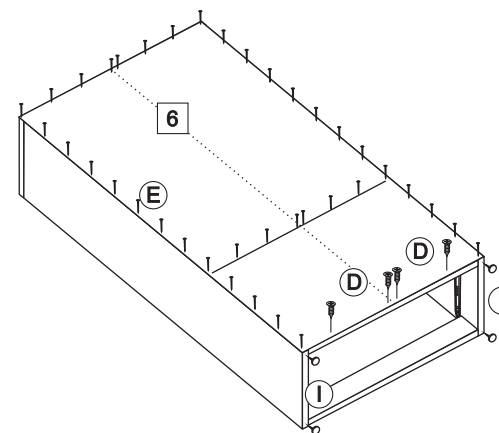

STEP 5

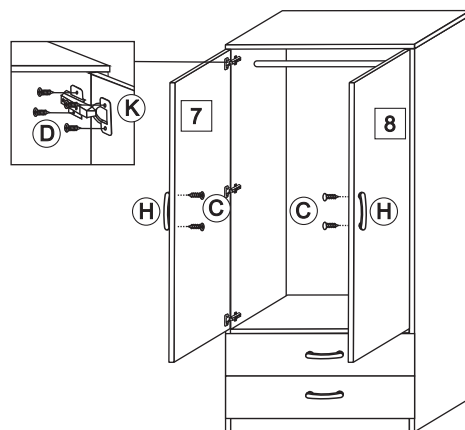

STEP 6

