

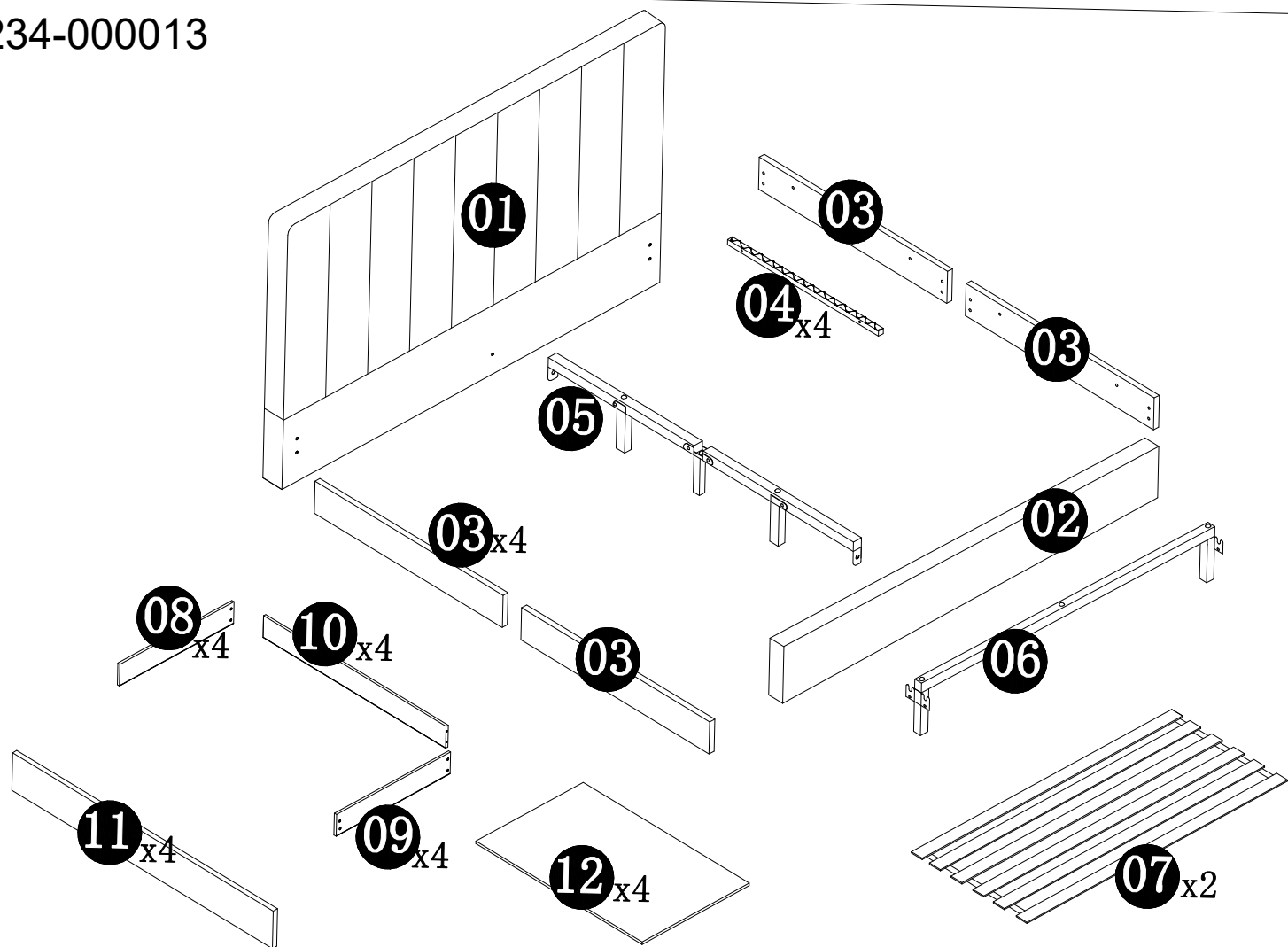







234-000013

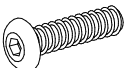
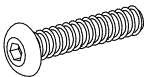
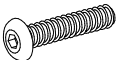
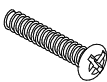

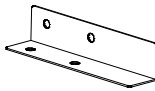

A		26
		8*15
B		8
		8*40
C		4
		8*50
D		5
		6*45
E		16
		4*25
F		32
		4*14
G		32
		4*10

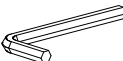
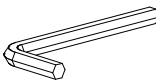
H		4
I		16
J		4
		4.5cm
R		16
		1.0
S		1
T		1
		M6
U		1
		M8

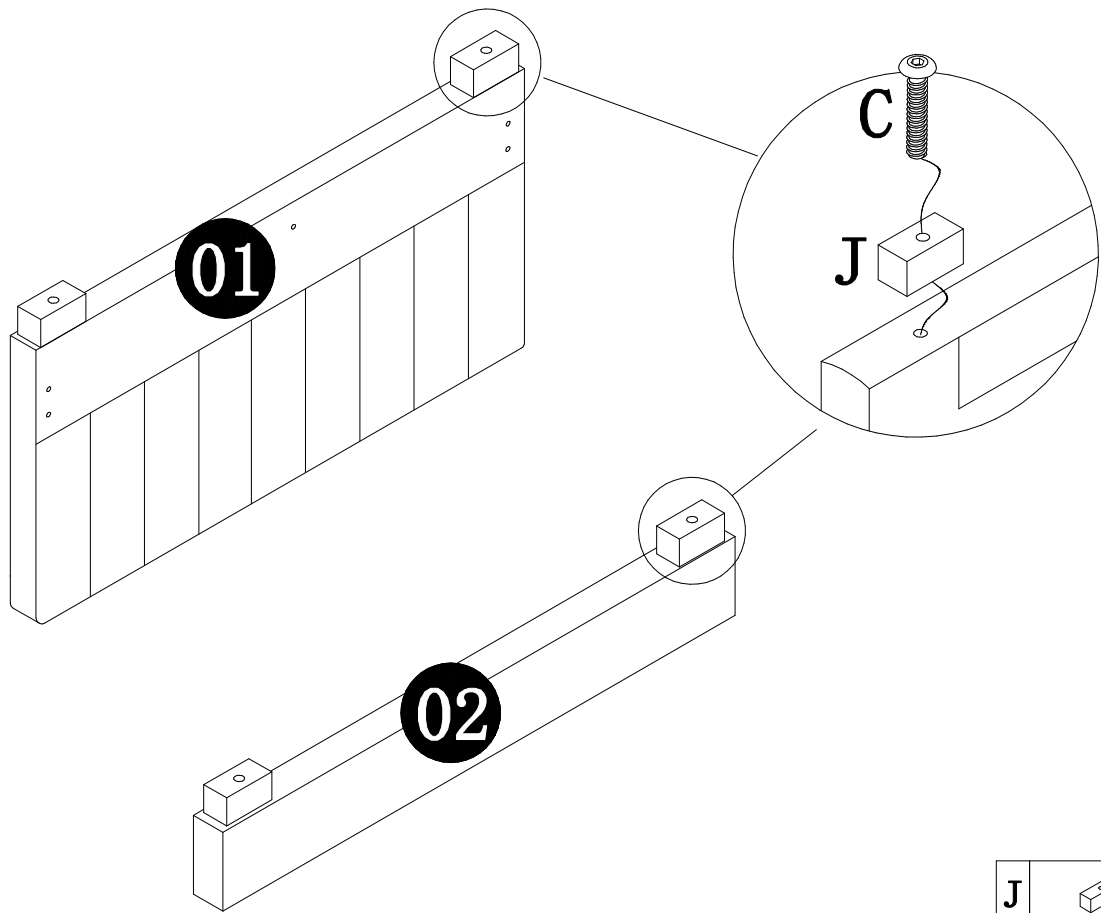
01



J	 4.5cm	4
C	 8*50	4

U	 M6	1
---	--	---

02

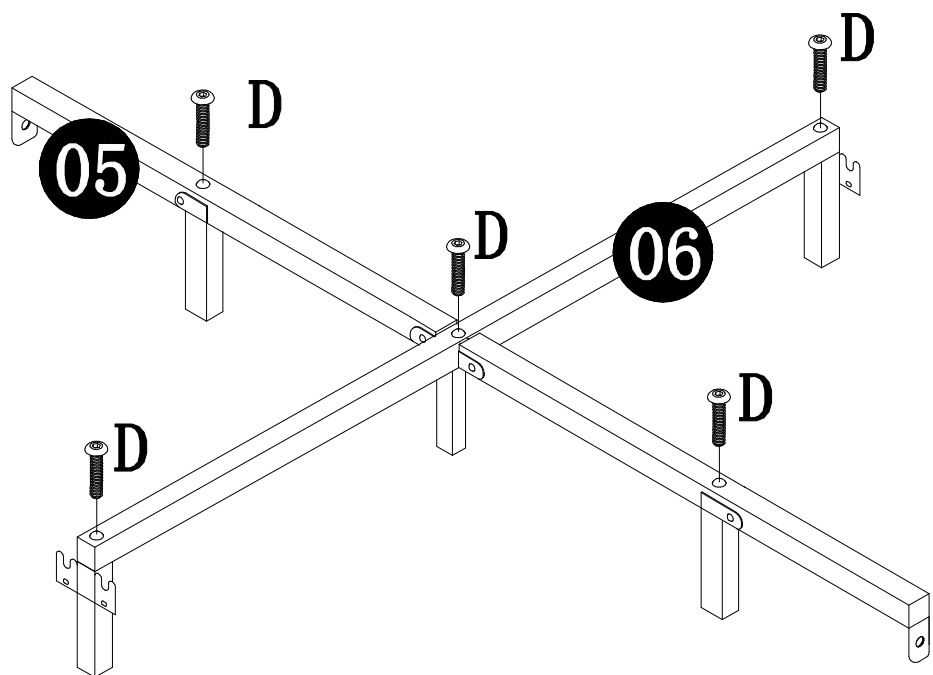

D	 6*45	5
---	---	---

T	 M6	1
---	--	---

03

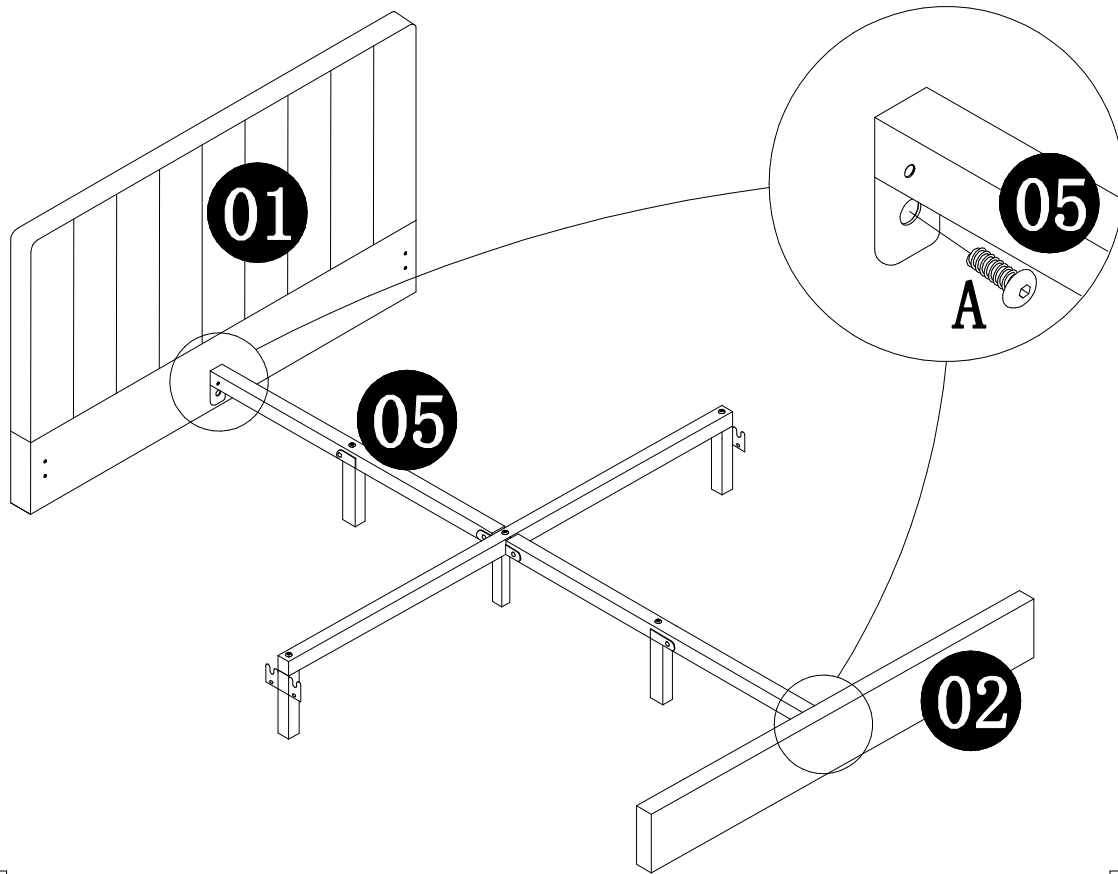

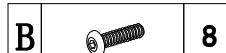
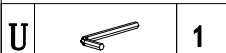
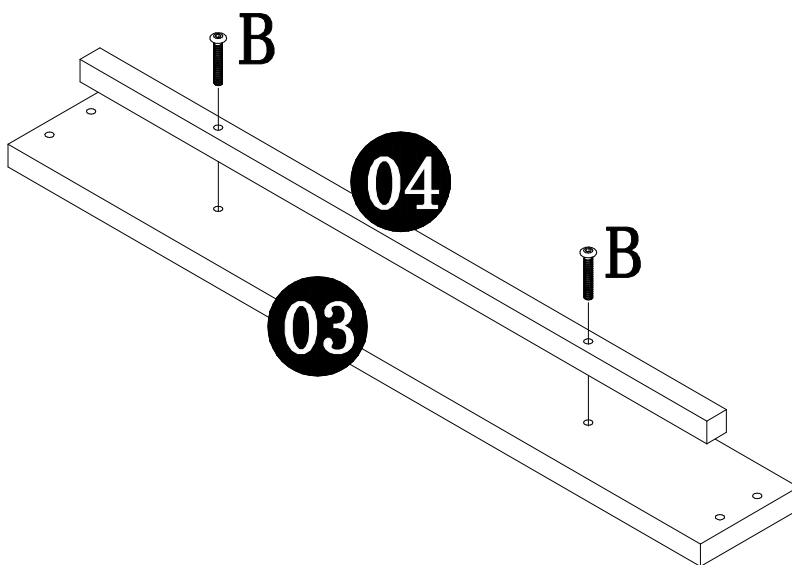

04

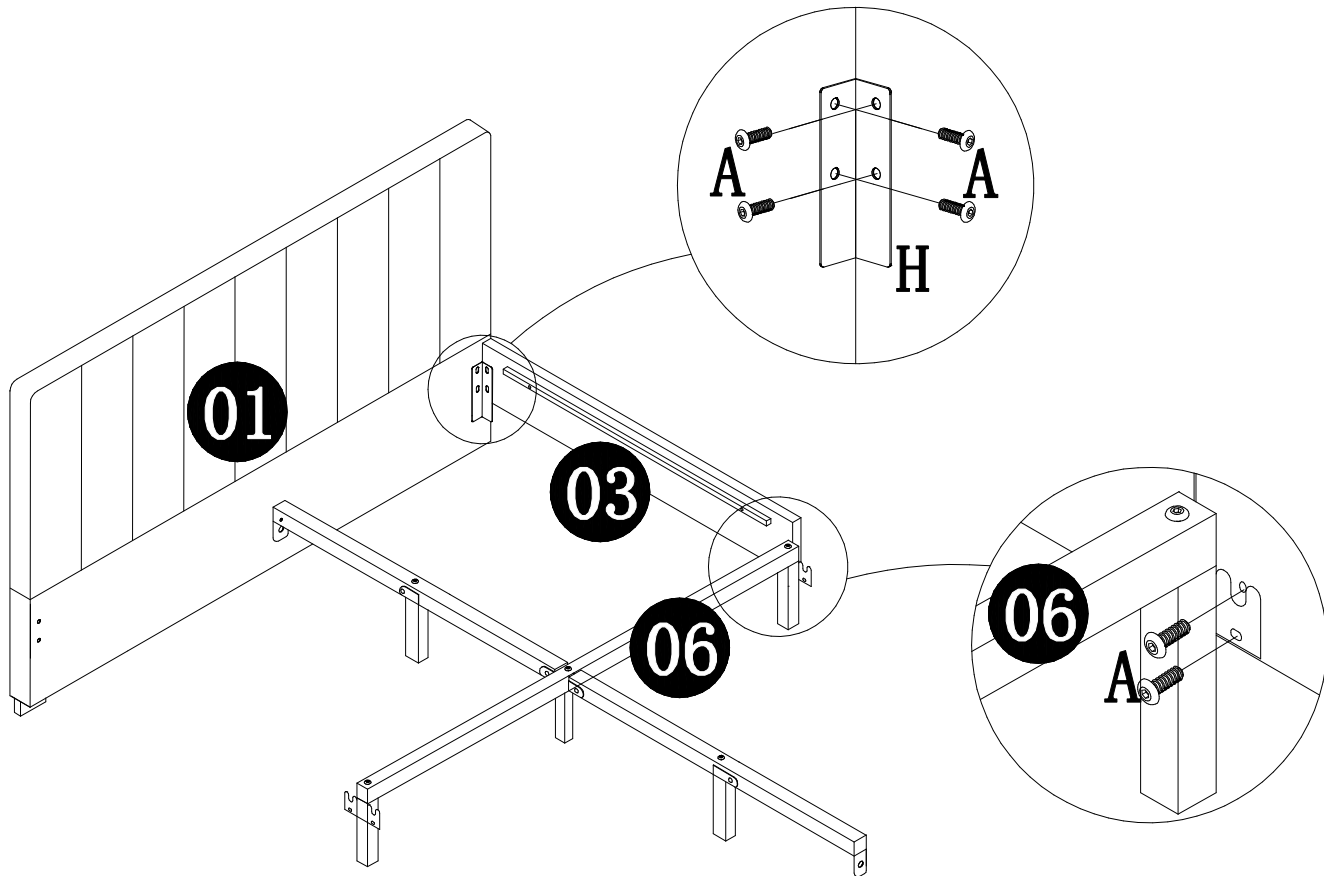

05





H		1
A		6

U		1
---	--	---

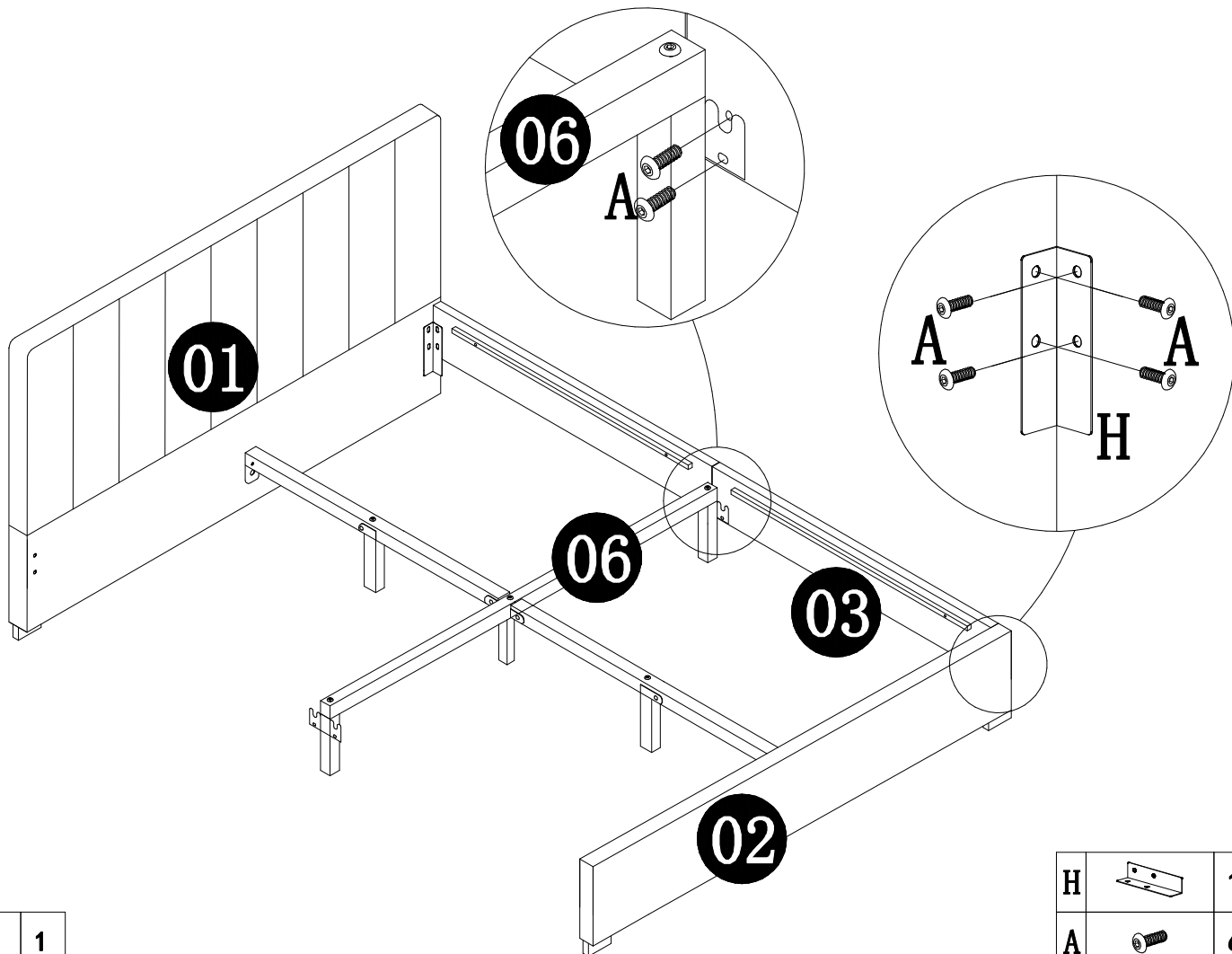
06



H		1
A		6

U		1
---	--	---

07

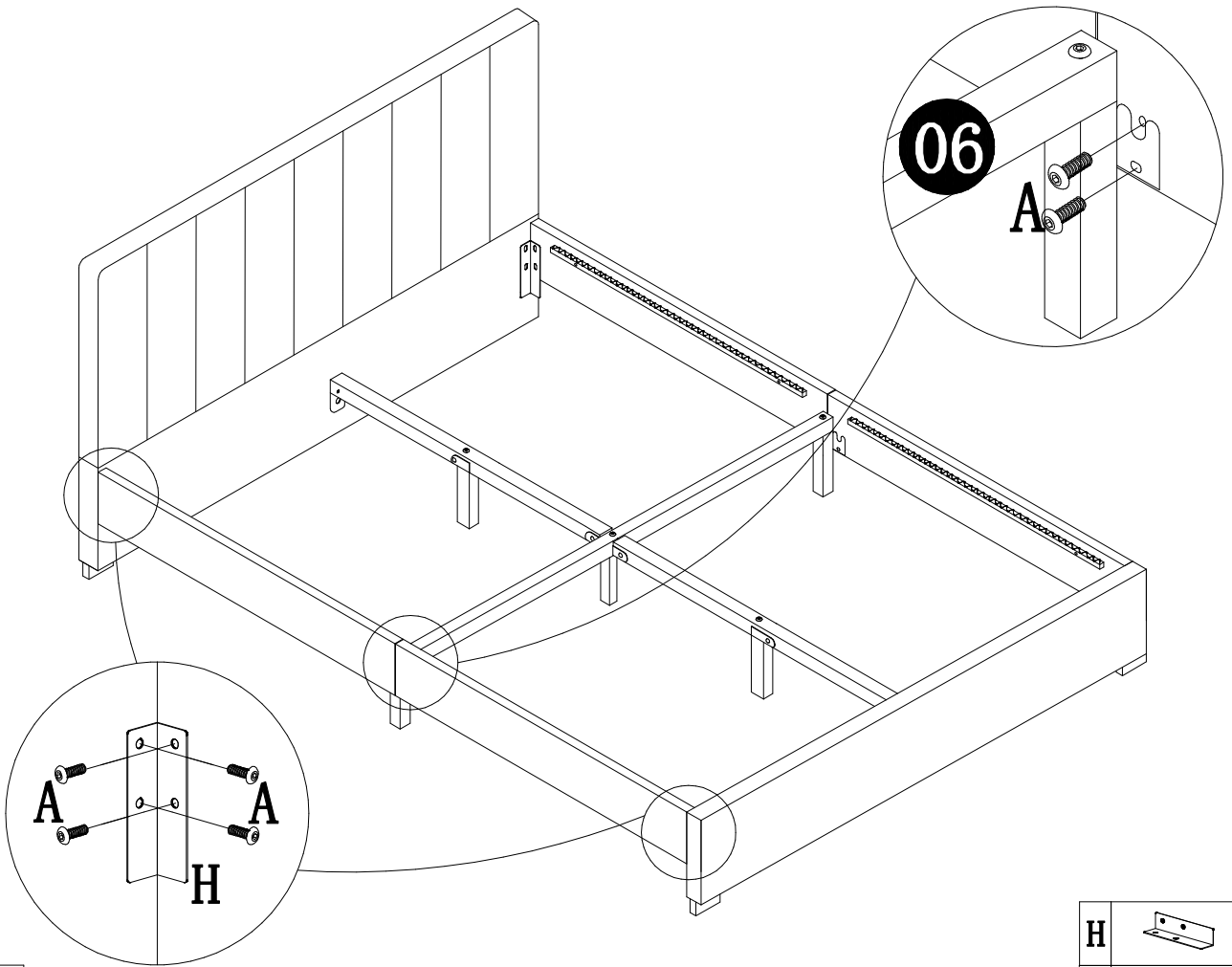

H		2
A		12

8\*15

U		1
---	--	---

08

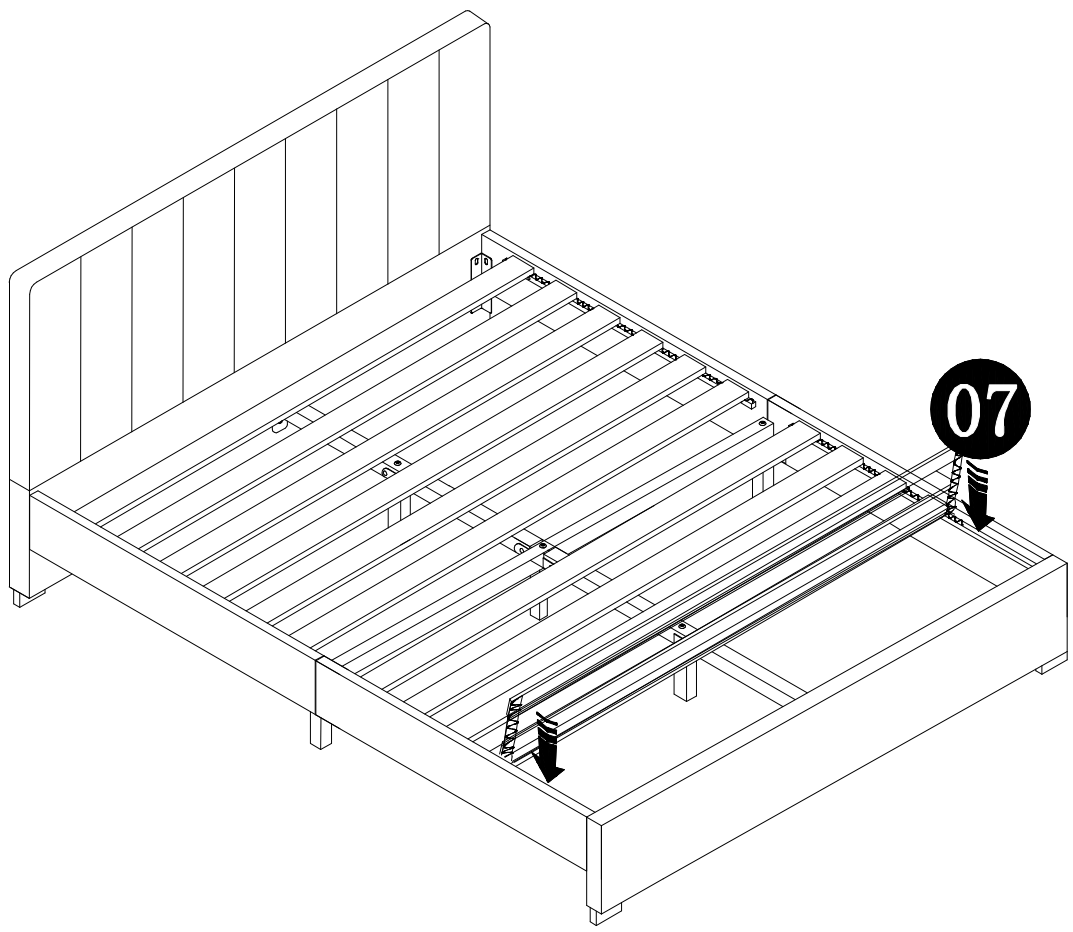

09

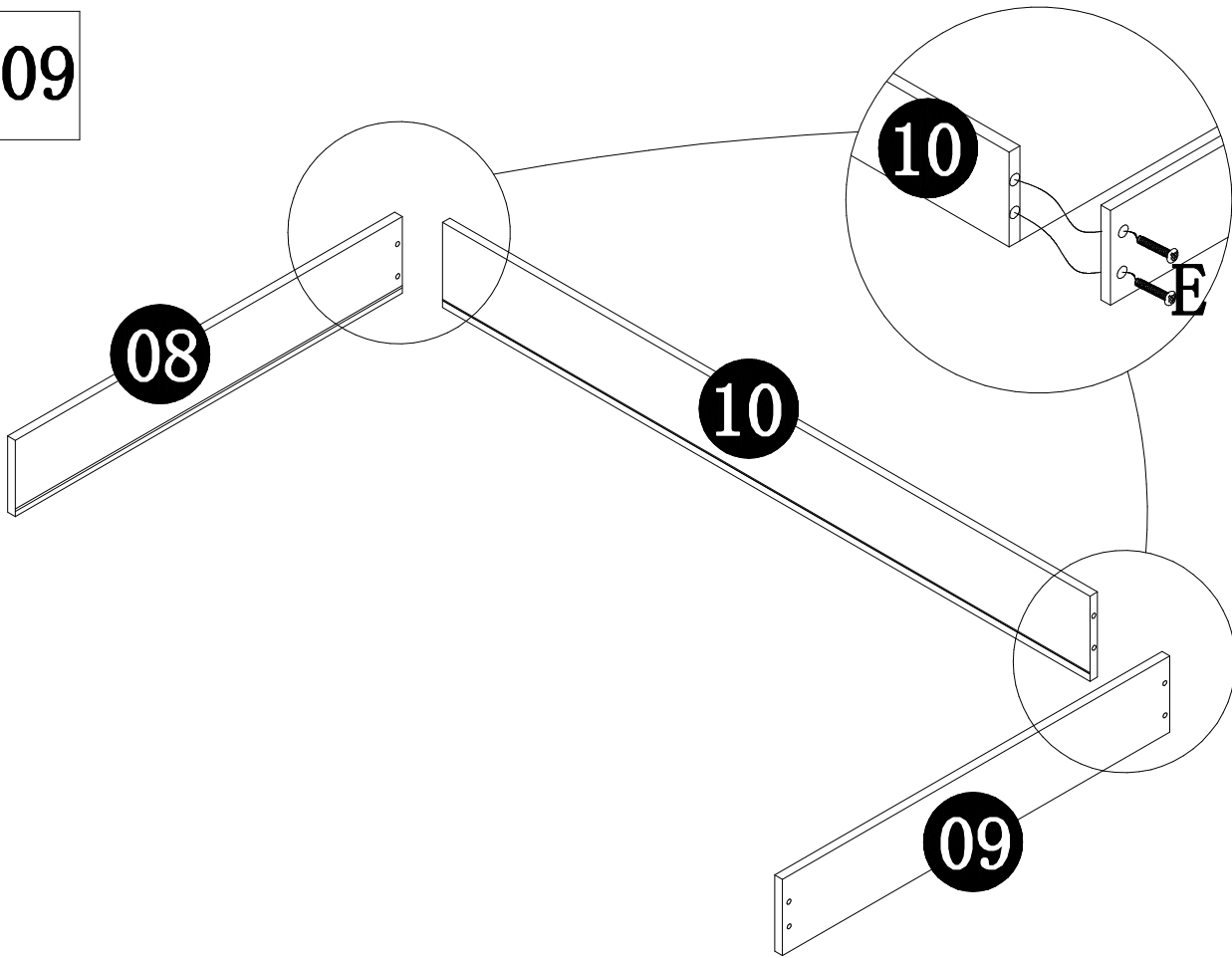

S		1
---	--	---

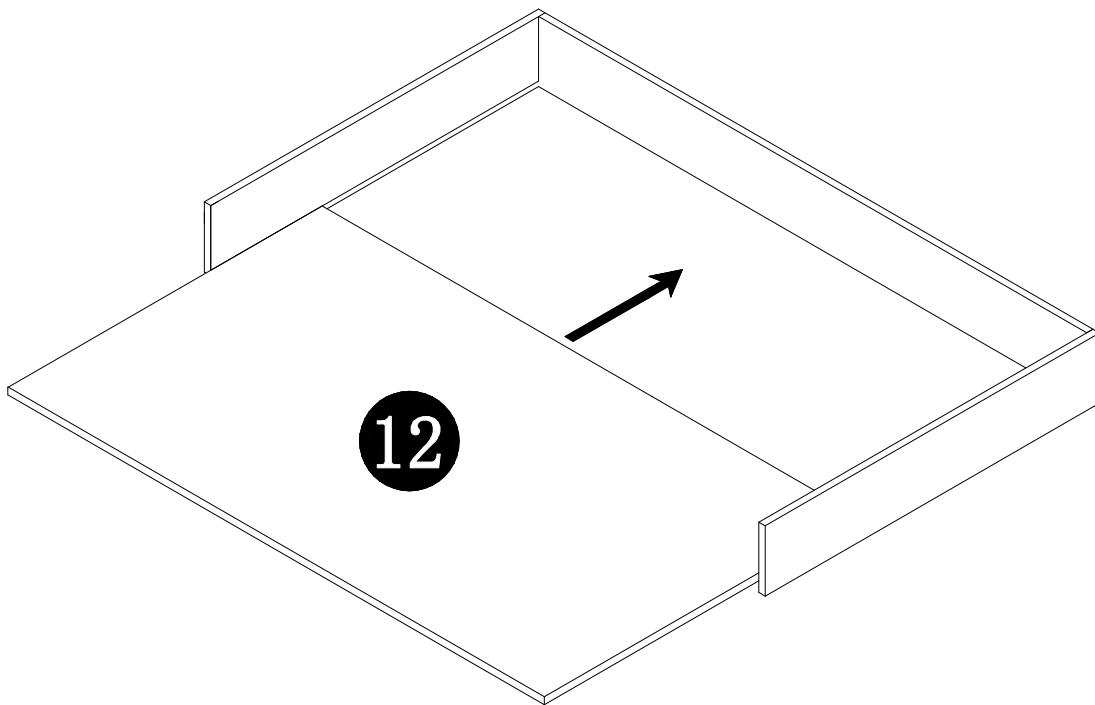

E		16
---	---	----

10

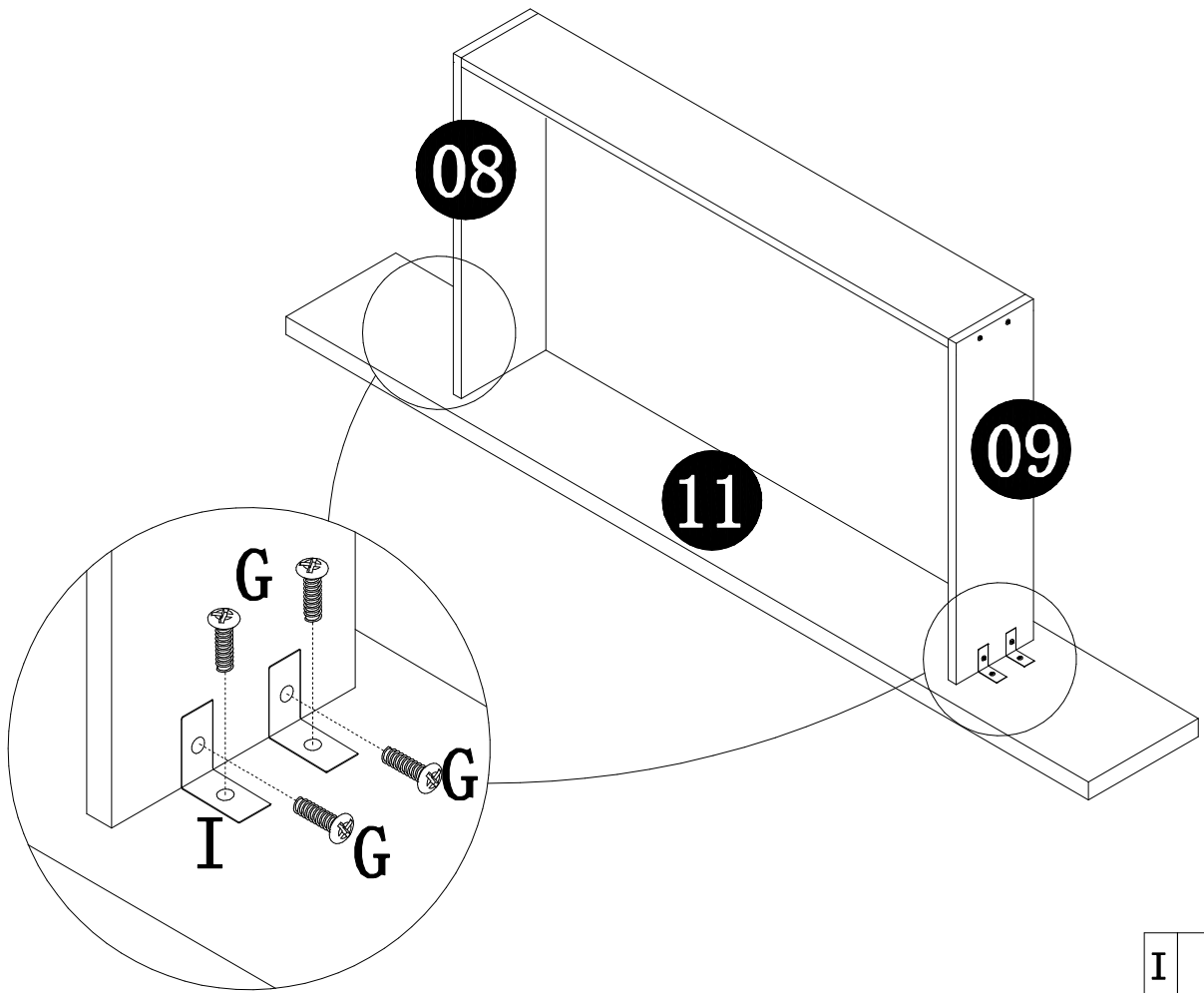

11





I		16
G		32

S		1
---	--	---

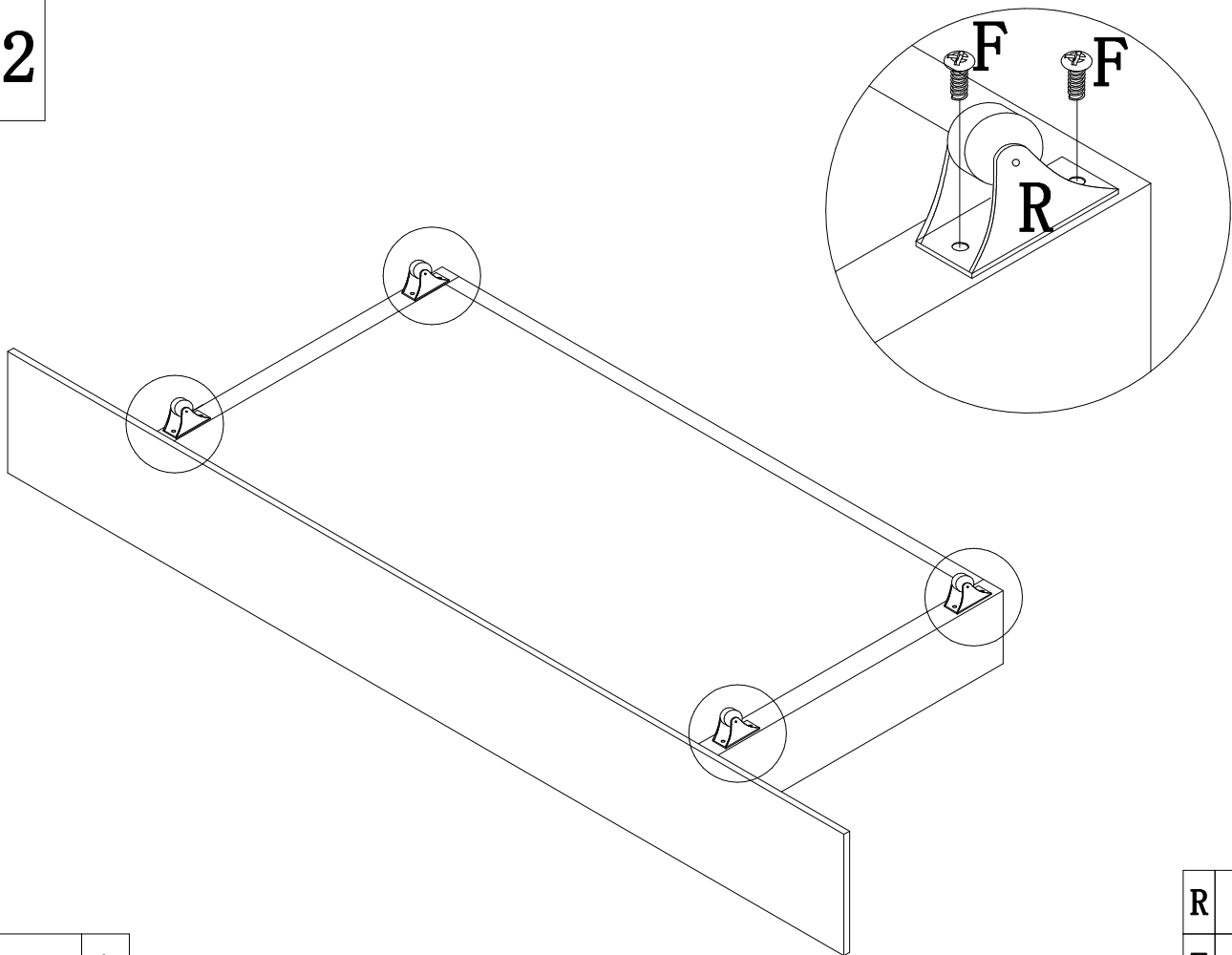
12



R		16
F		32

S		1
---	--	---

