



Dear Customer,

We design and produce our product for people to love and have fun with them as we do.

The product you bought was subjected to all sorts of tests and control before sending out to you.

Before start assembling, please check the whole components and accessories according to the lists. If you bought more than one product, to prevent confusion be sure that you completed the first product. Then start the other product's assembling.

Before start assembling, please clean all the components with a damp cloth. Also for usual cleaning, this will be enough.

Although all the products are produced and packed carefully, sometimes happen that some component is damaged during the transportation. In such a case please check the missing or damaged part and do not hesitate to contact us.

Do not use furniture for other purposes. If you would like to use it, please contact us for further questions.









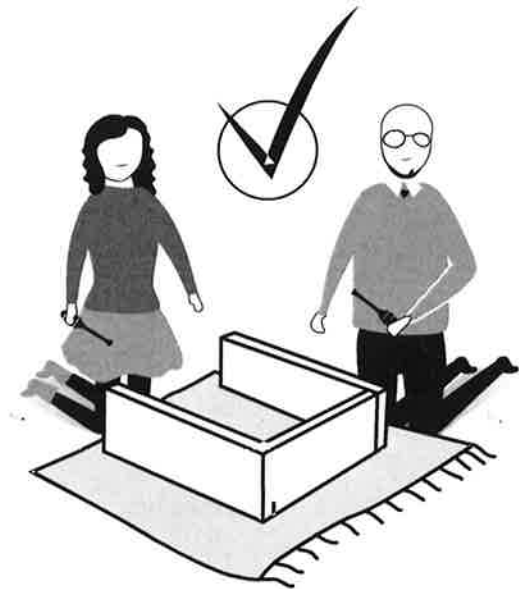



Do not directly contact your furniture with excessive heat, cold and humidity because the product can be affected.

## WARNING

Serious or fatal crushing injuries can occur from furniture tip-over. To prevent this furniture from tipping over it must be permanently fixed to the wall with the included wall attachment devices.

Fixing devices for the wall are not included since different wall materials require different types of fixing devices. Use fixing devices suitable for the walls in your home. For advice on suitable fixing systems, contact your local specialized dealer.



HARDWARE LIST			
NO	DESCRIPTION		QTY
I	JCBCW SCREW M6.3 x 50		16pcs
II	M4 ALLEN KEY		1pc
III	HANDLE & SCREW M4 x 22		2sets
IV	HANDLE & SCREW M4 x 22		2sets
V	STICKER		12pcs
VI	M8 x 30 PLASTIC DOWEL		10pcs
VII	PVC NAIL WITH PIN		5pcs
VIII	NAIL		50pcs
IX	PE CLIP & SCREW M3.5 X 16		16sets
X	HIPS STOPPER & SCREW M3.5 x 16		2sets
XI	HINGE(C) & SCREW M3.5 x 16		8sets
XII	M4 x 25 CHIPBOARD SCREW		14pcs
XIII	Q-FIT		4sets

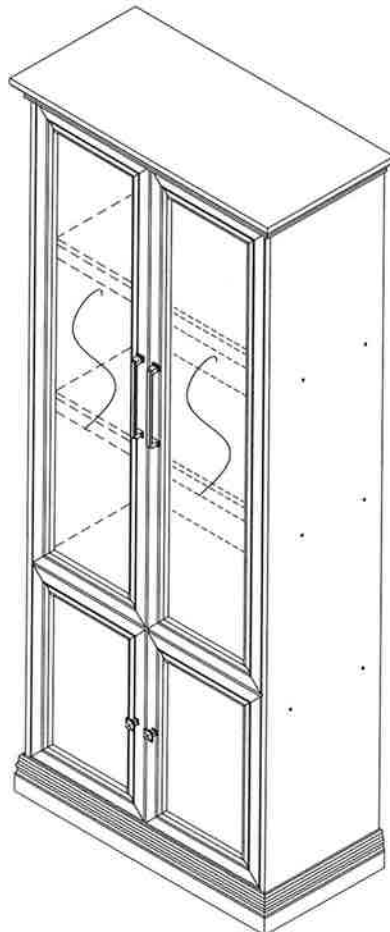

# STEP 1

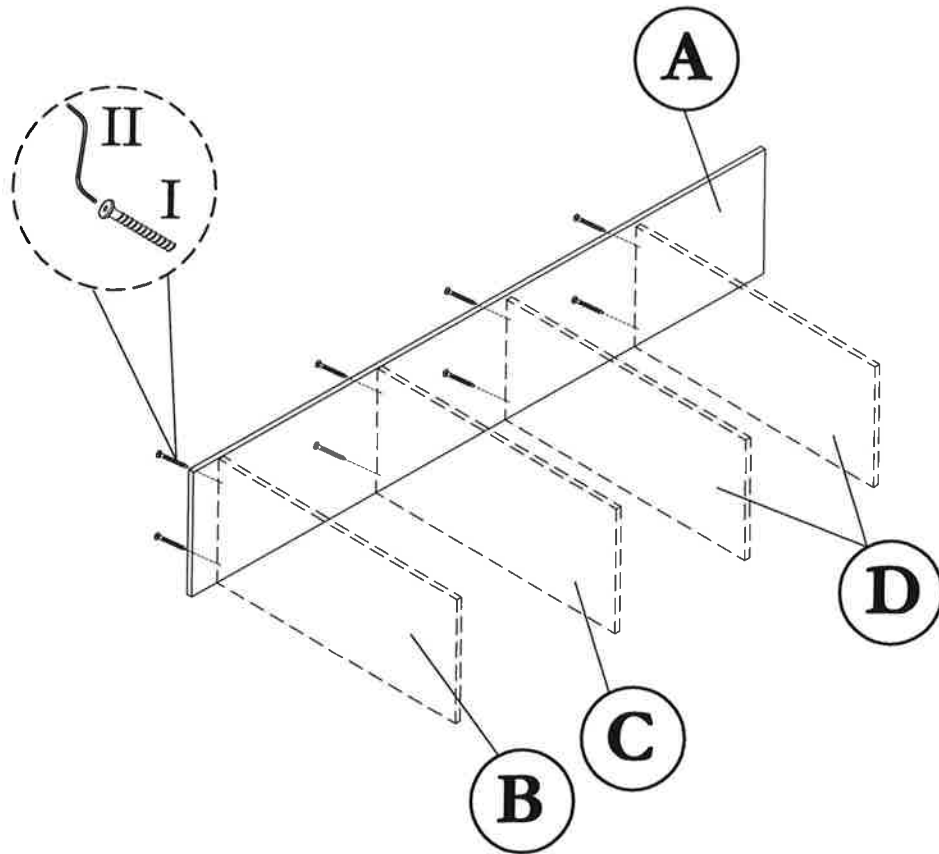

# STEP 2

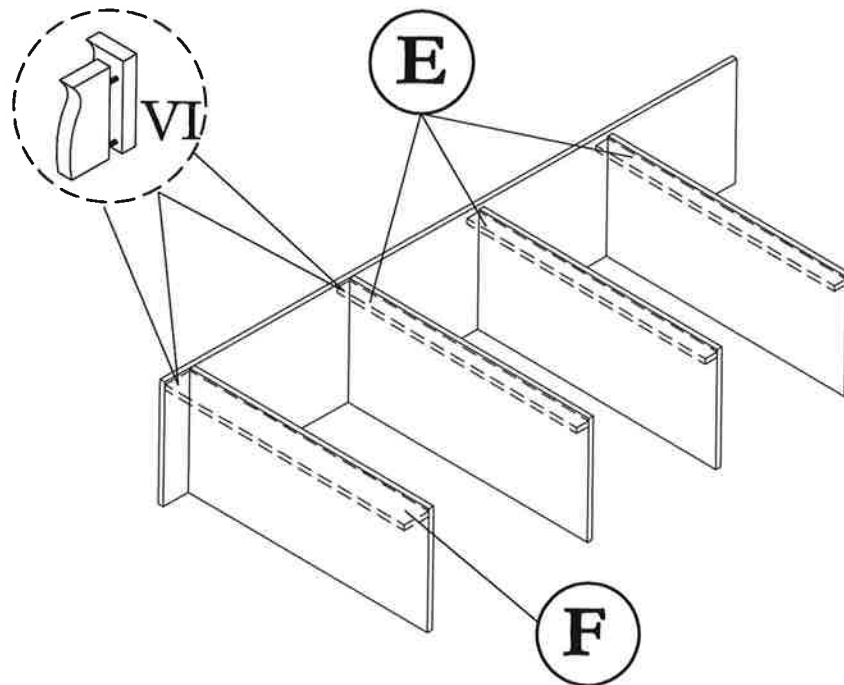

### STEP 3

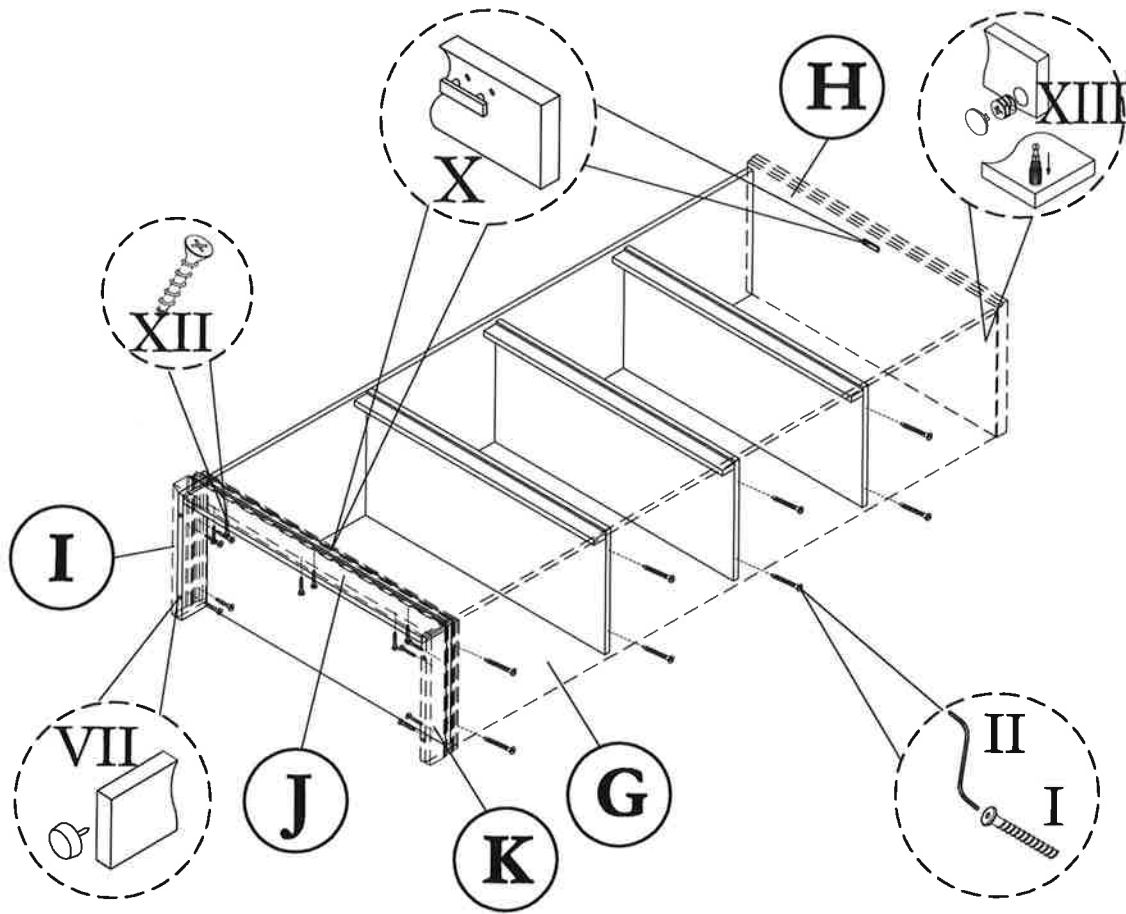

### STEP 4

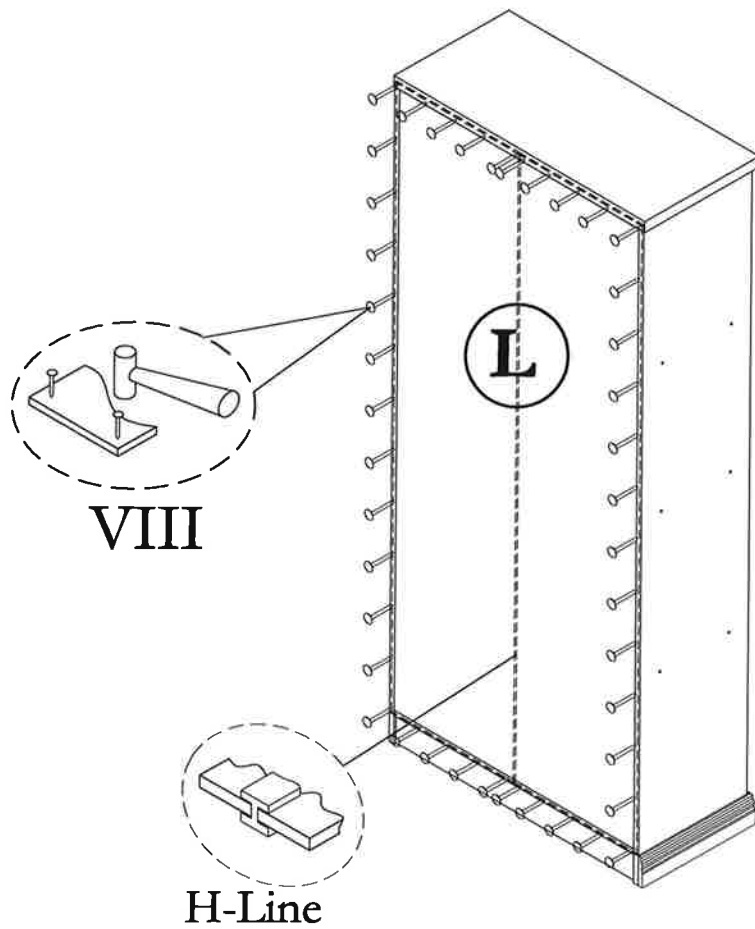

## STEP 5

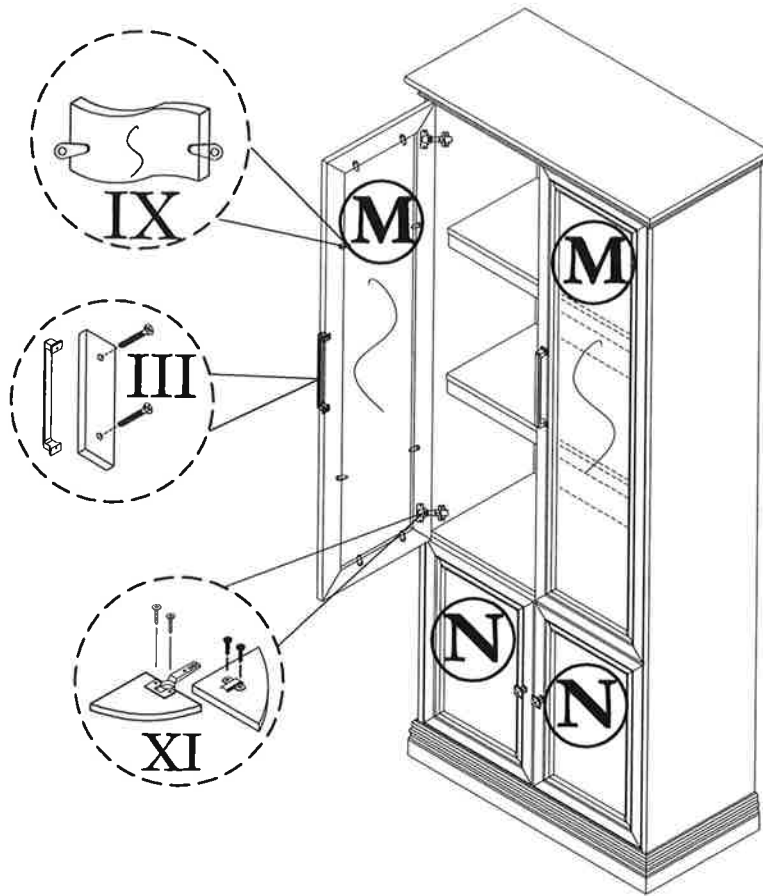

## STEP 6

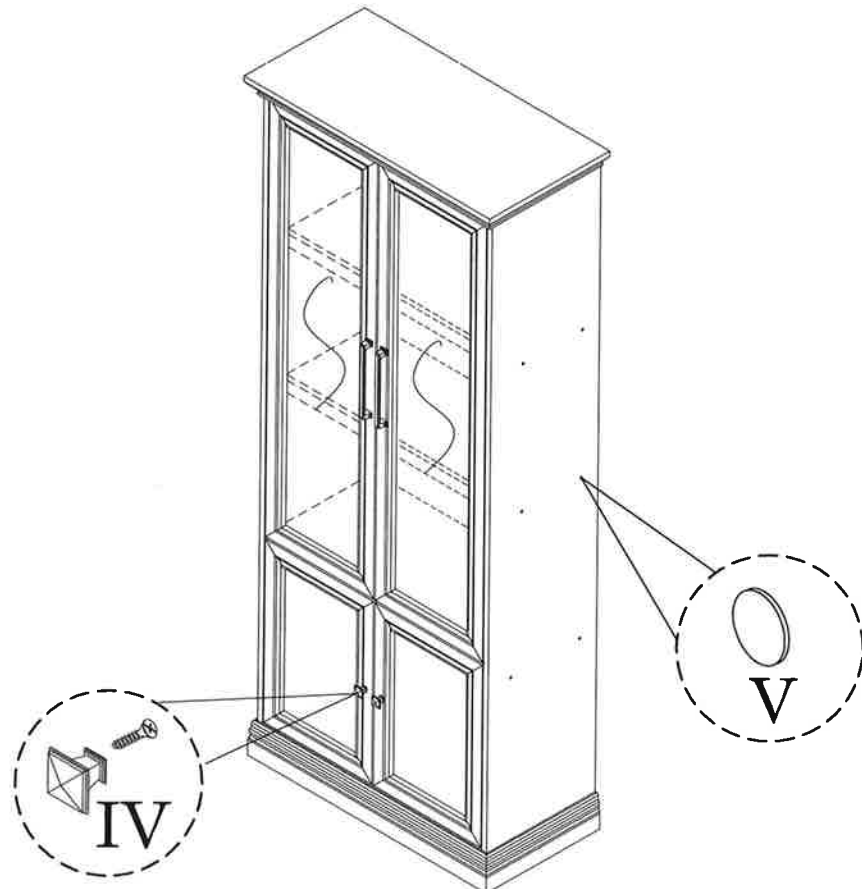

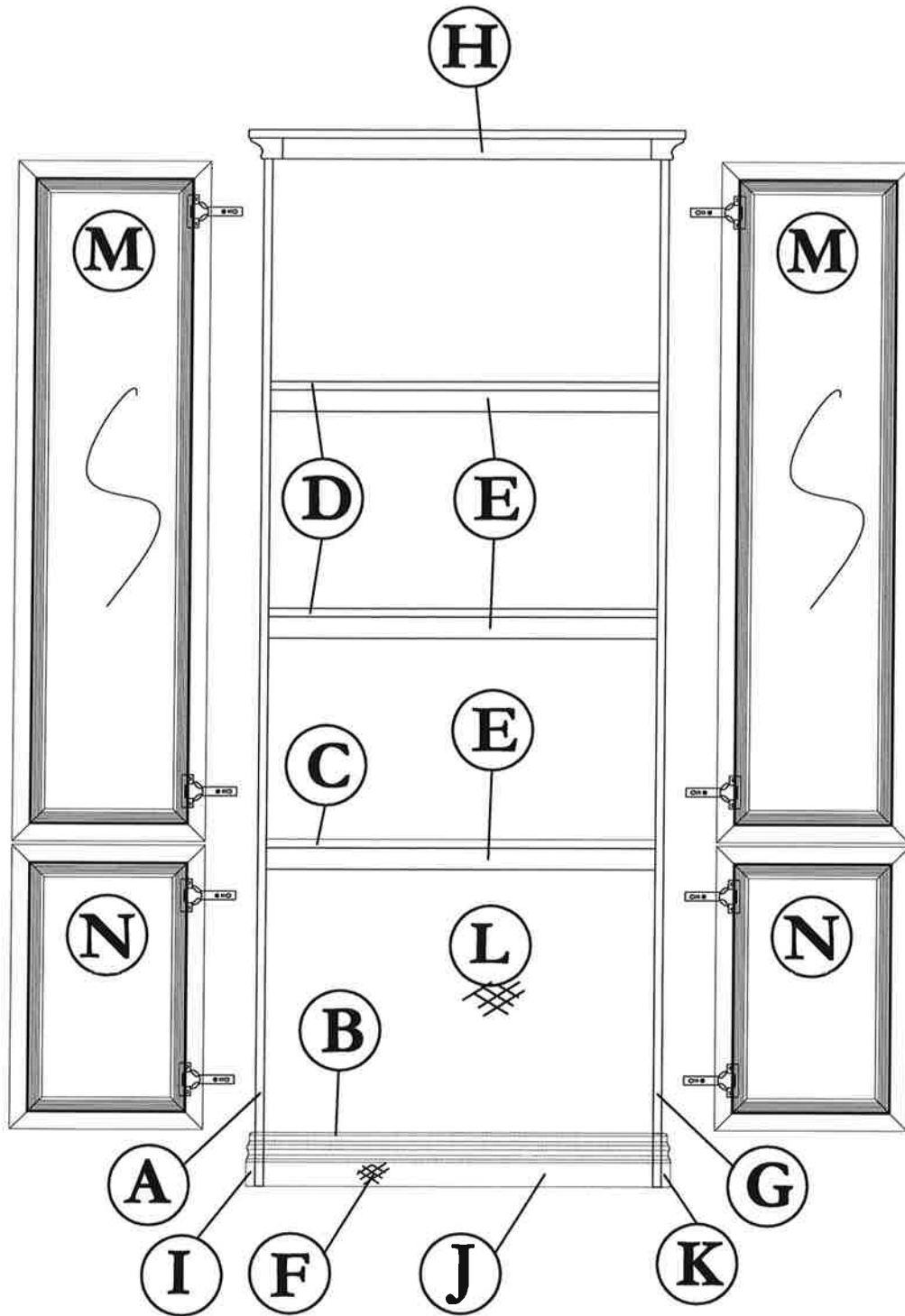

NO	DESCRIPTION	QTY
A	LEFT SIDE	01
B	LOWER SHELF	01
C	CENTRE SHELF	01
D	CENTRE SHELF	02
E	SHELF SUPPORT	03
F	LEG	01
G	RIGHT SIDE	01

NO	DESCRIPTION	QTY
H	TOP	01
I	LEFT SIDE WRAPPING	01
J	FRONT WRAPPING	01
K	RIGHT SIDE WRAPPING	01
L	BACK	02
M	LEFT/RIGHT SIDE DOOR (Top)	02
N	LEFT/RIGHT SIDE DOOR (Bottom)	02