





This module should be assembled by two people.

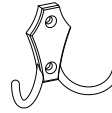

ACCESSORY LIST

A18 3,5x18  16x	A53 4x70  4x	A54 4x30  4x	F04  4x	F02  4x
A16 Ø8  4x				

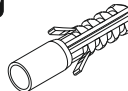
GENERAL VIEW

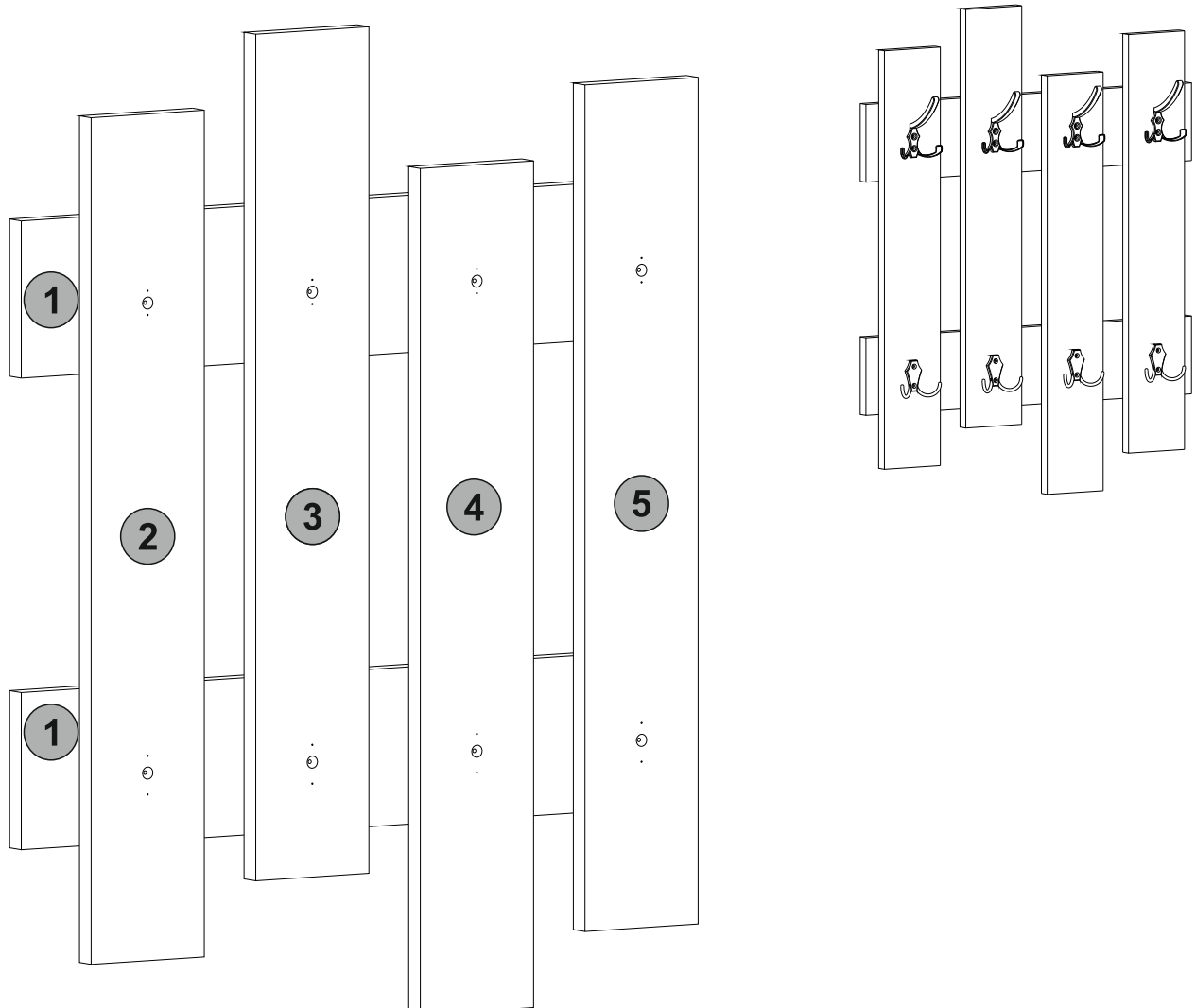

1

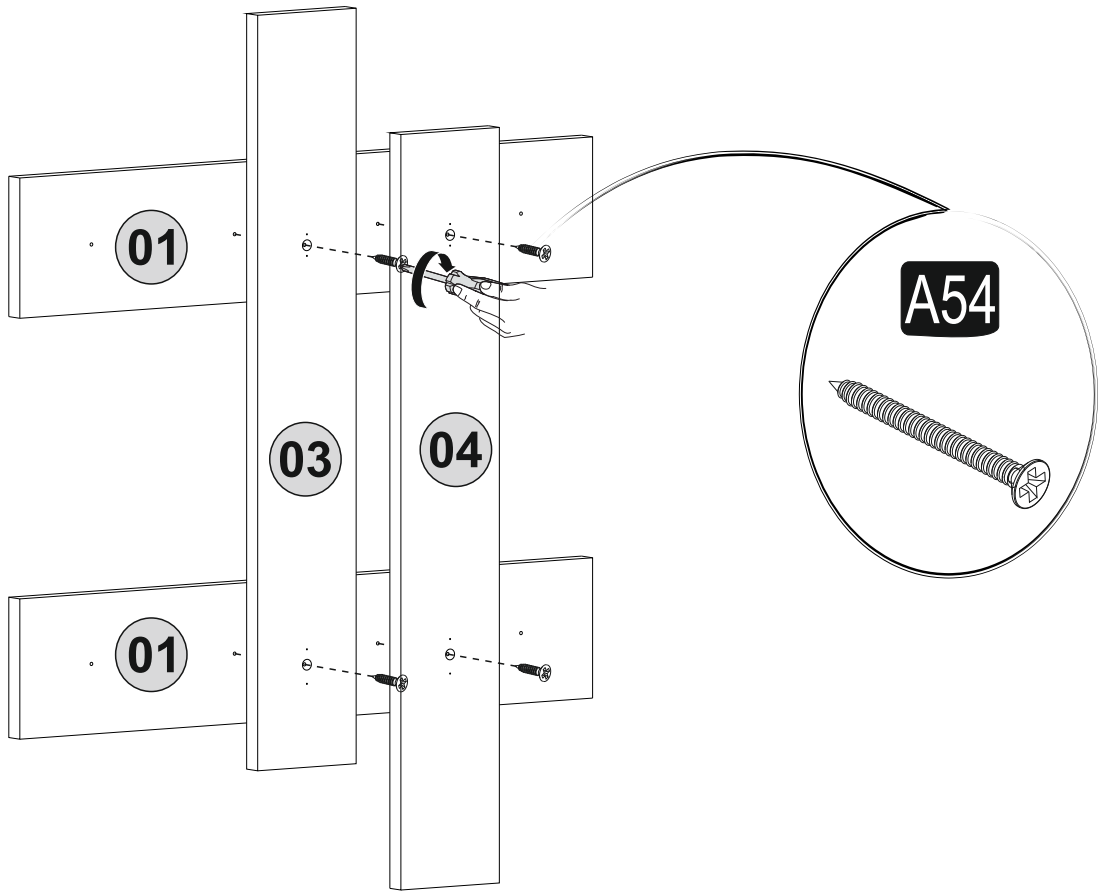

2

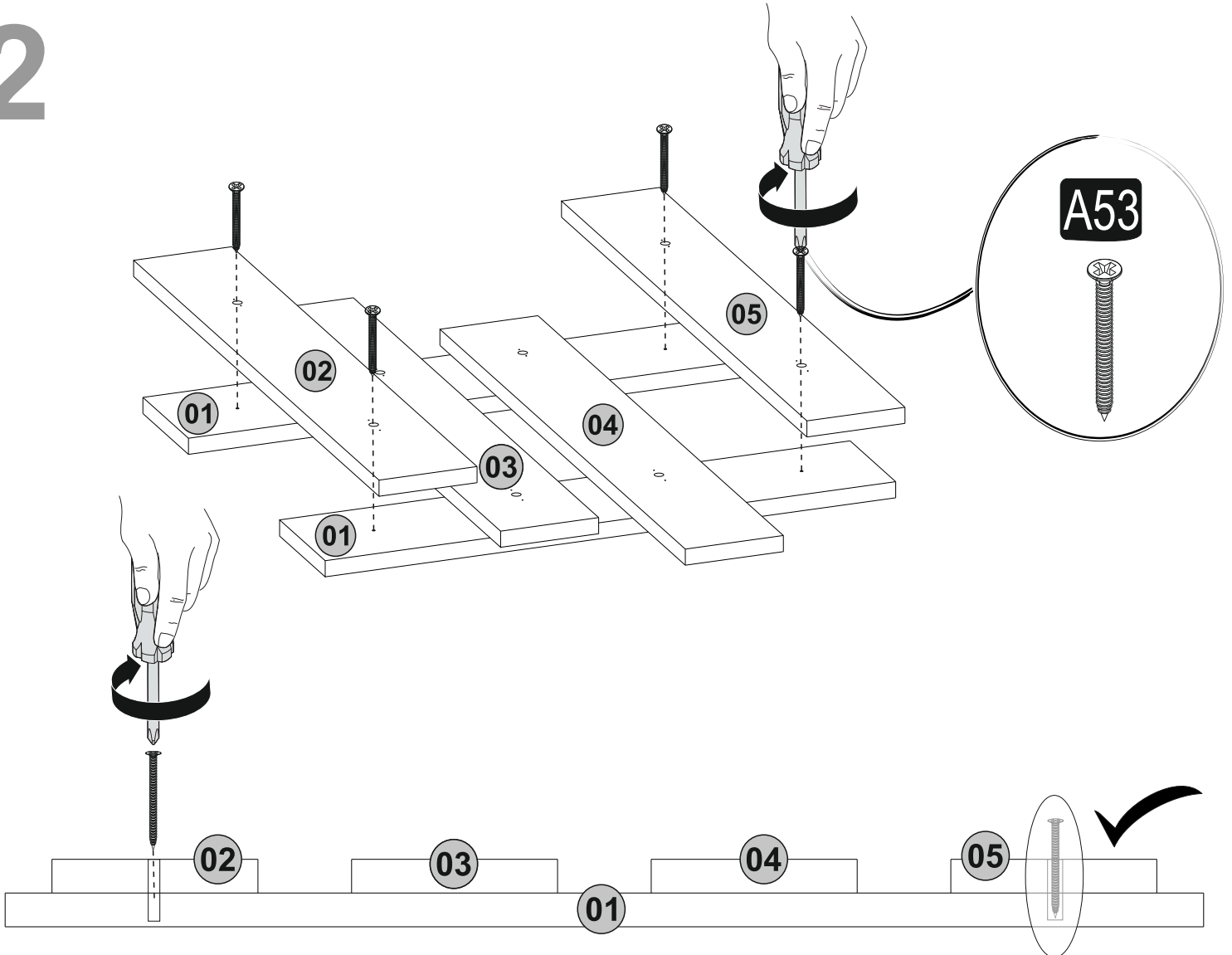

3

3

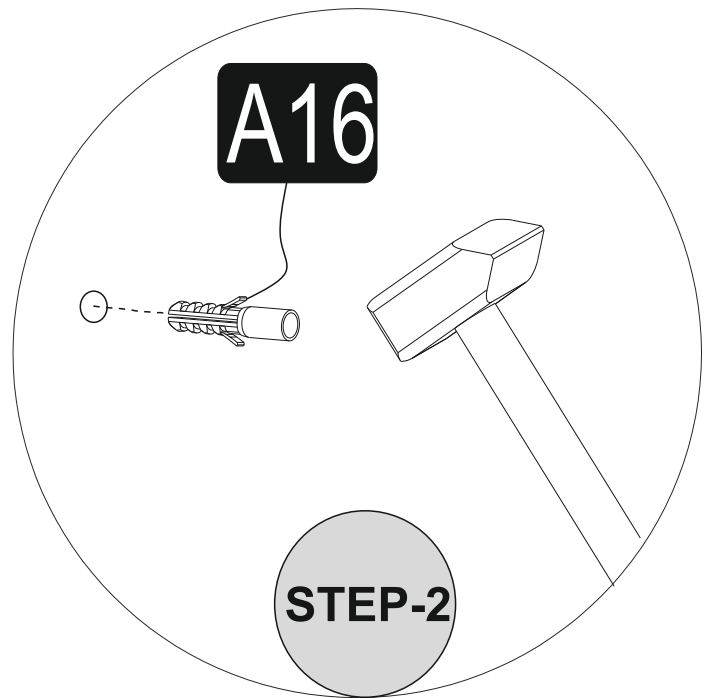
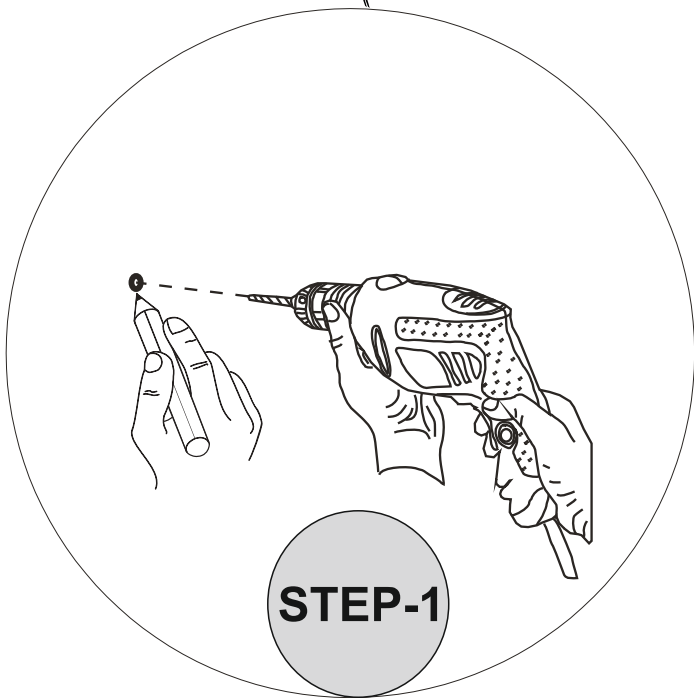
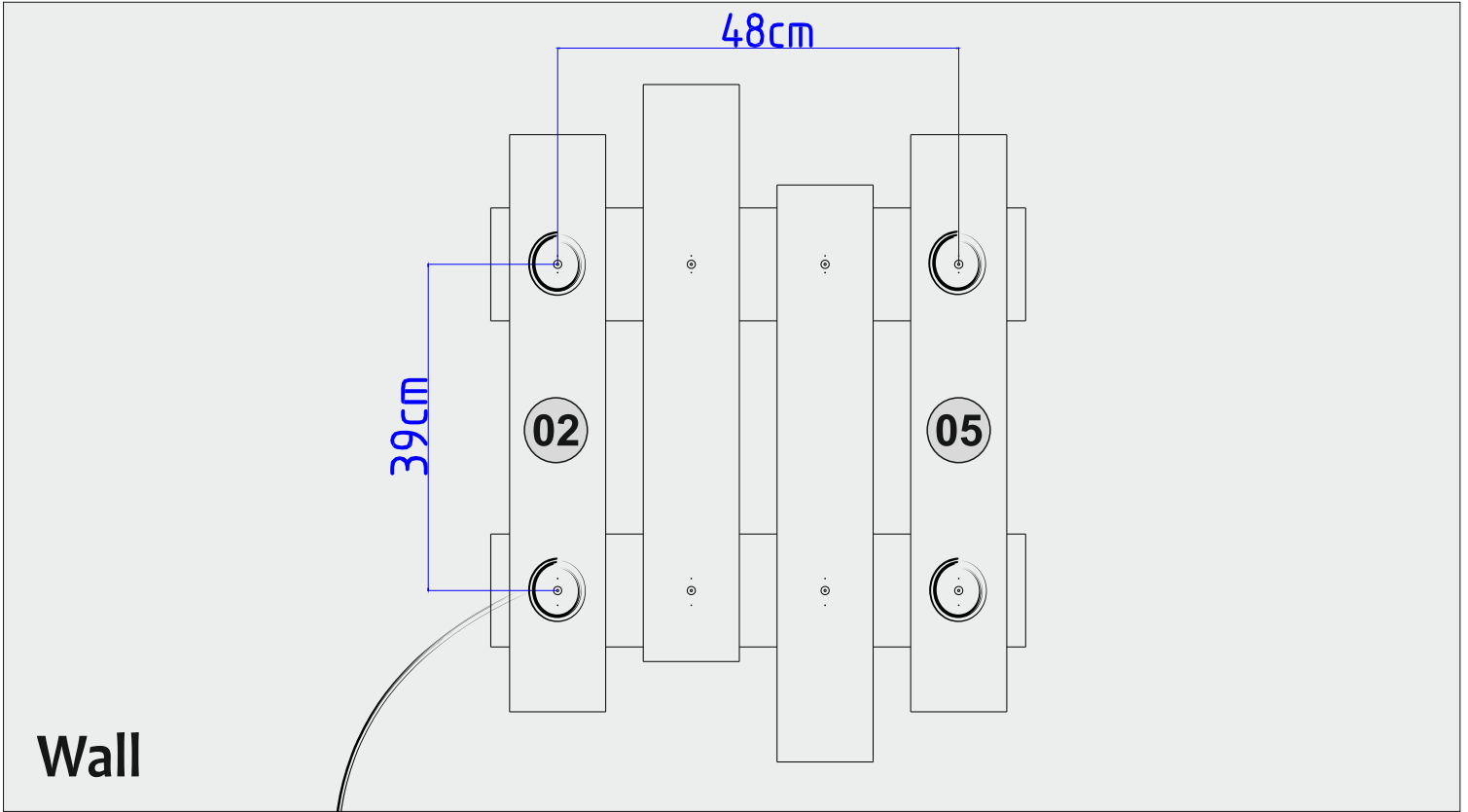

4

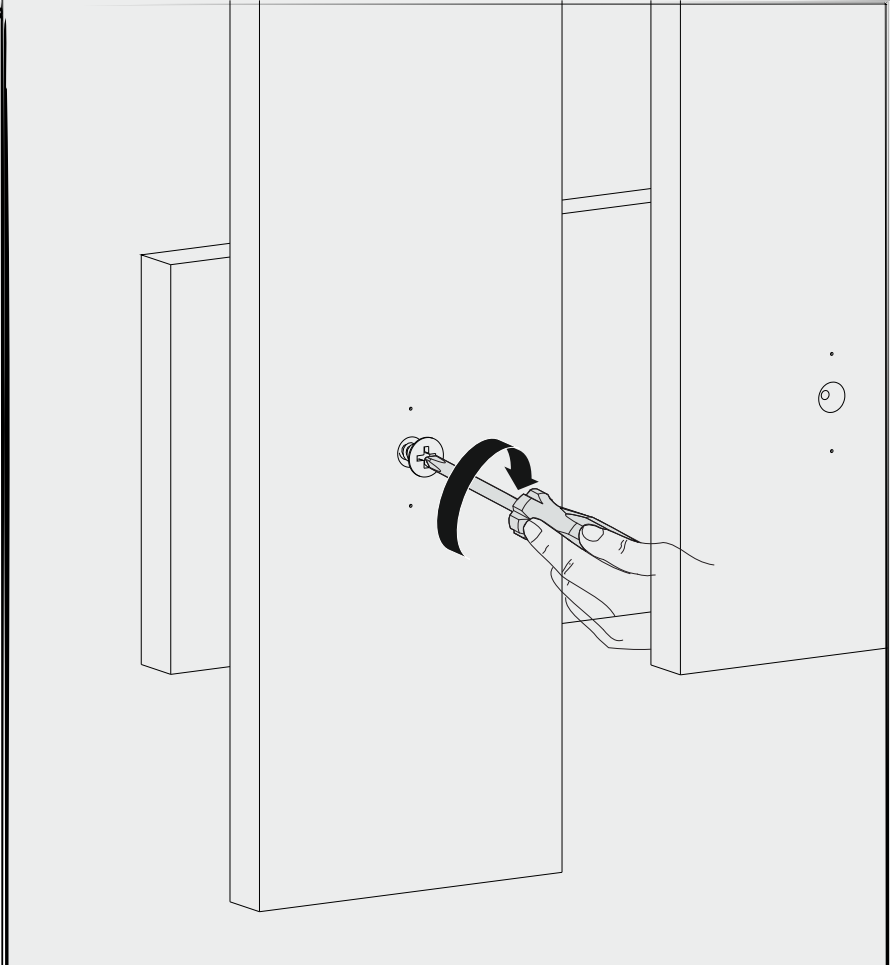
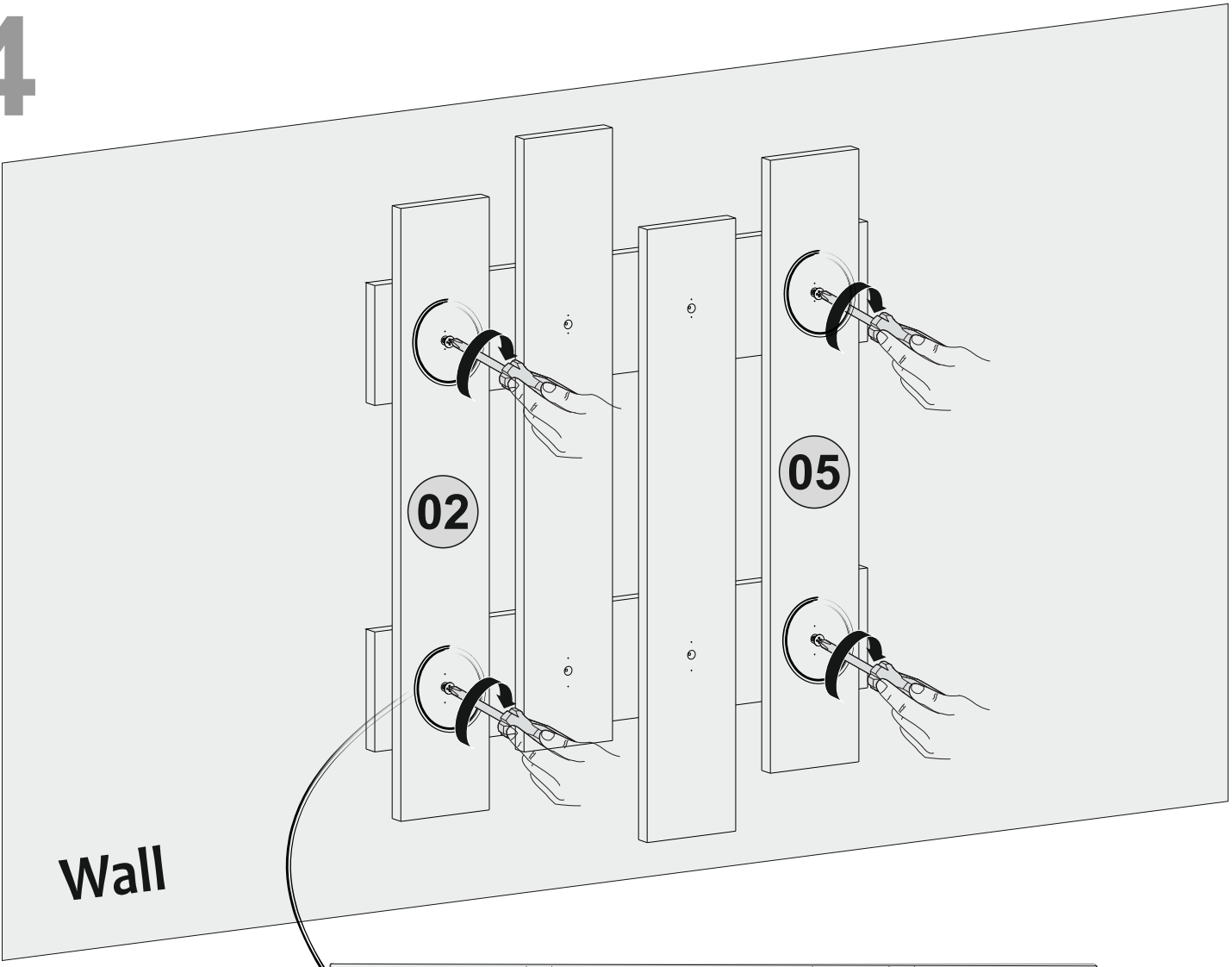

5

5

