

OPPA

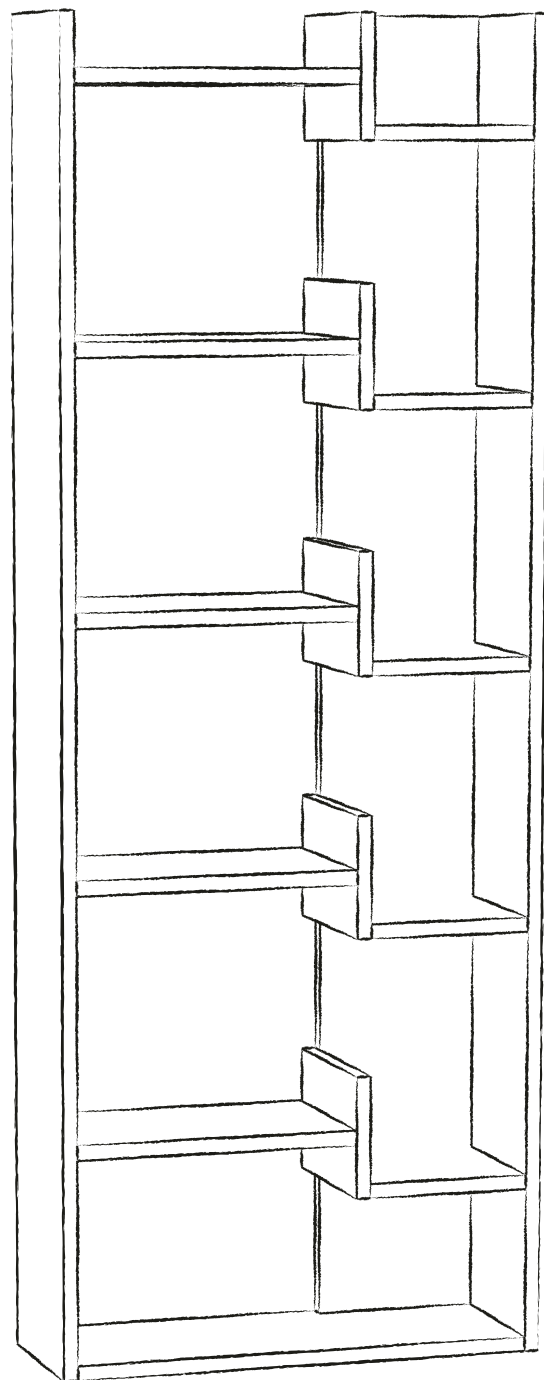



Dear Customer,

We design and produce our product for people to love and have fun with them as we do.

The product you bought was subjected to all sorts of tests and control before sending out to you.

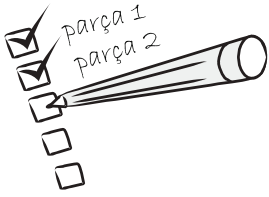

Before start assembling, please check the whole components and accessories according to the lists. If you bought more than one product, to prevent confusion be sure that you completed the first product. Then start the other product's assembling.



Before start assembling, please clean all the components with a damp cloth. Also for usual cleaning, this will be enough.



Although all the products are produced and packed carefully, sometimes happen that some component is damaged during the transportation. In such a case please check the missing or damaged part and do not hesitate to contact us.

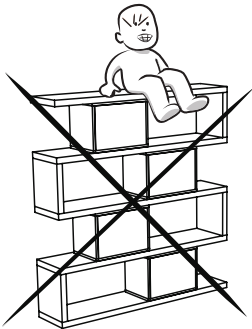

Do not use furniture for out of purposes. If you would like to use it, please contact us for further questions.

Do not directly contact your furniture with excessive heat, cold and humidity because the product can be affected.



WARNING

Serious or fatal crushing injuries can occur from furniture tip-over. To prevent this furniture from tipping over it must be permanently fixed to the wall with the included wall attachment devices.

Fixing devices for the wall are not included since different wall materials require different types of fixing devices. Use fixing devices suitable for the walls in your home. For advice on suitable fixing systems, contact your local specialized dealer.

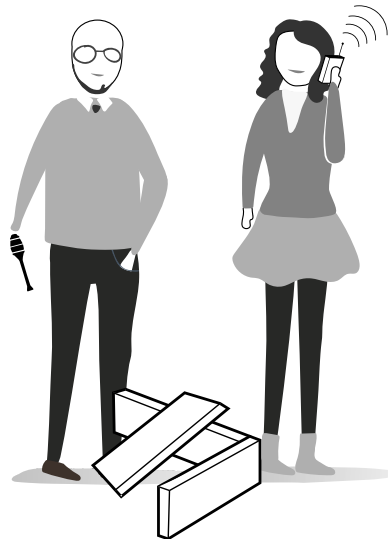
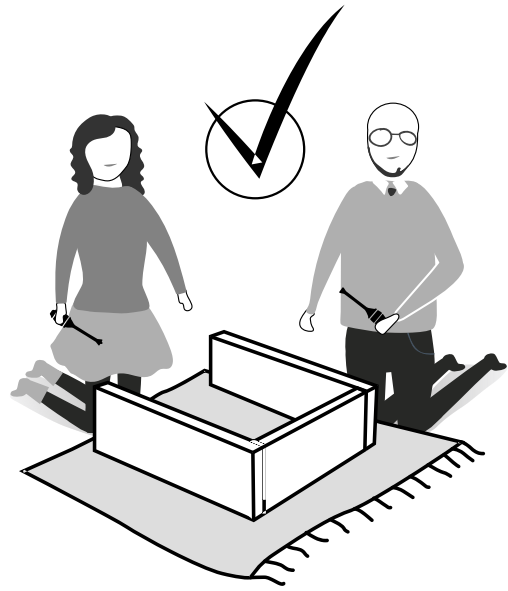
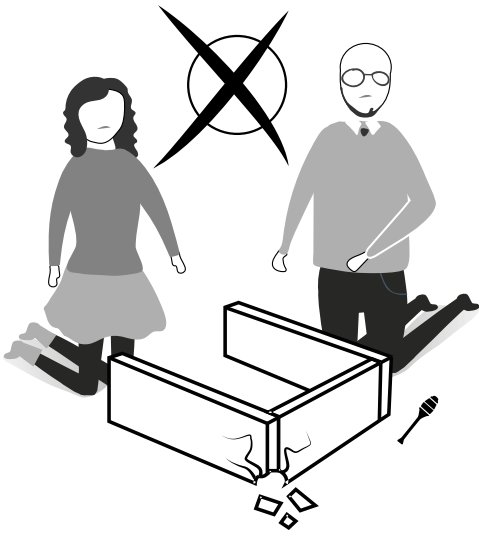
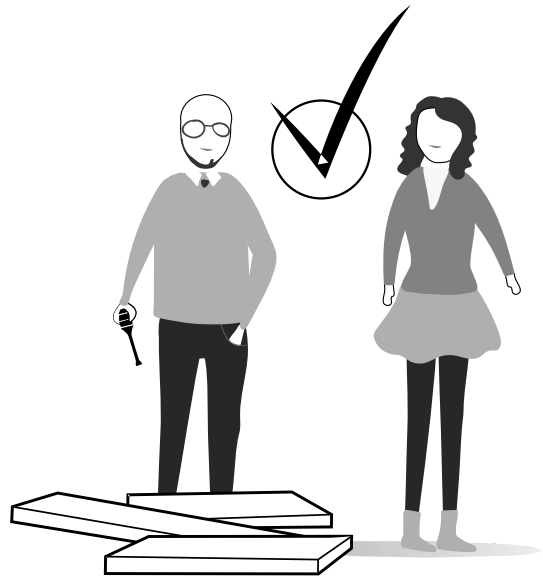
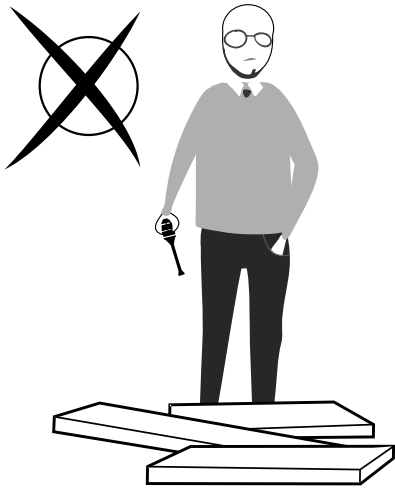







This module should be assembled by two people.

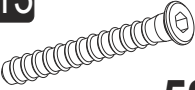

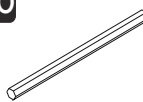
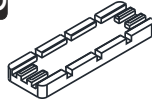
ACCESSORY LIST

A13 50 mm  52x	A12 4 SW  1x	A26 Allen  1x	A08  4x	A06 18 mm  52x
--	--	---	--	--

GENERAL VIEW

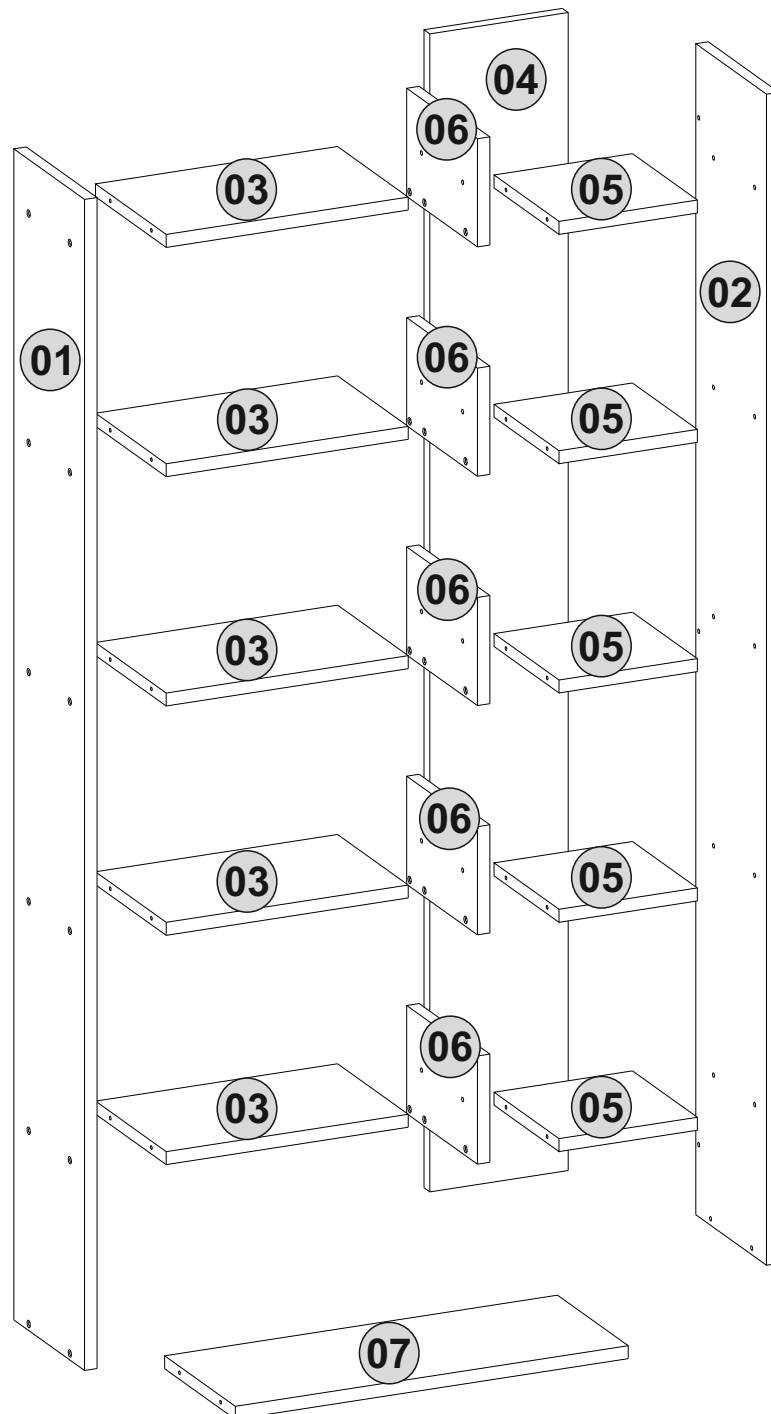

1. step

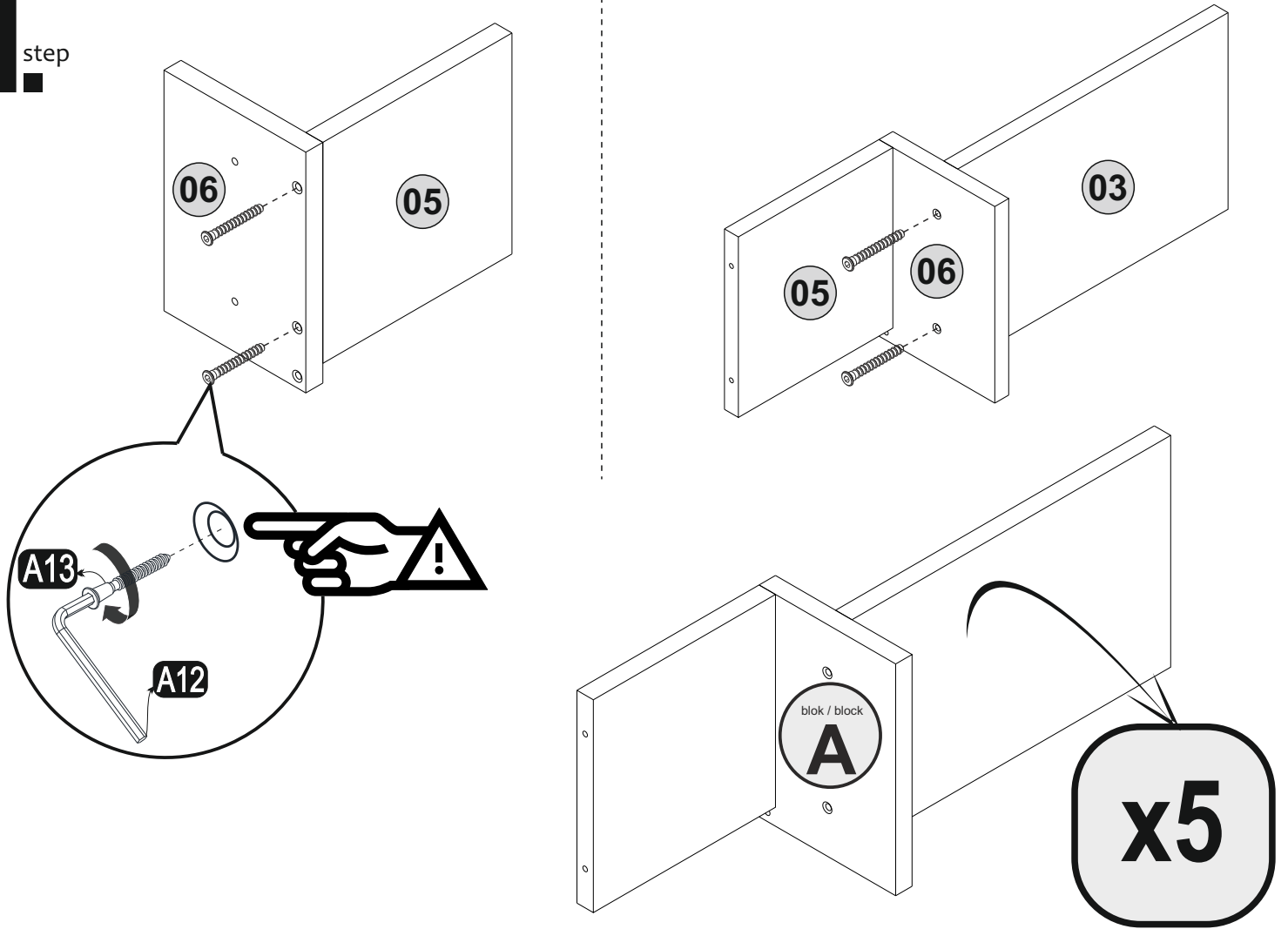

2. step

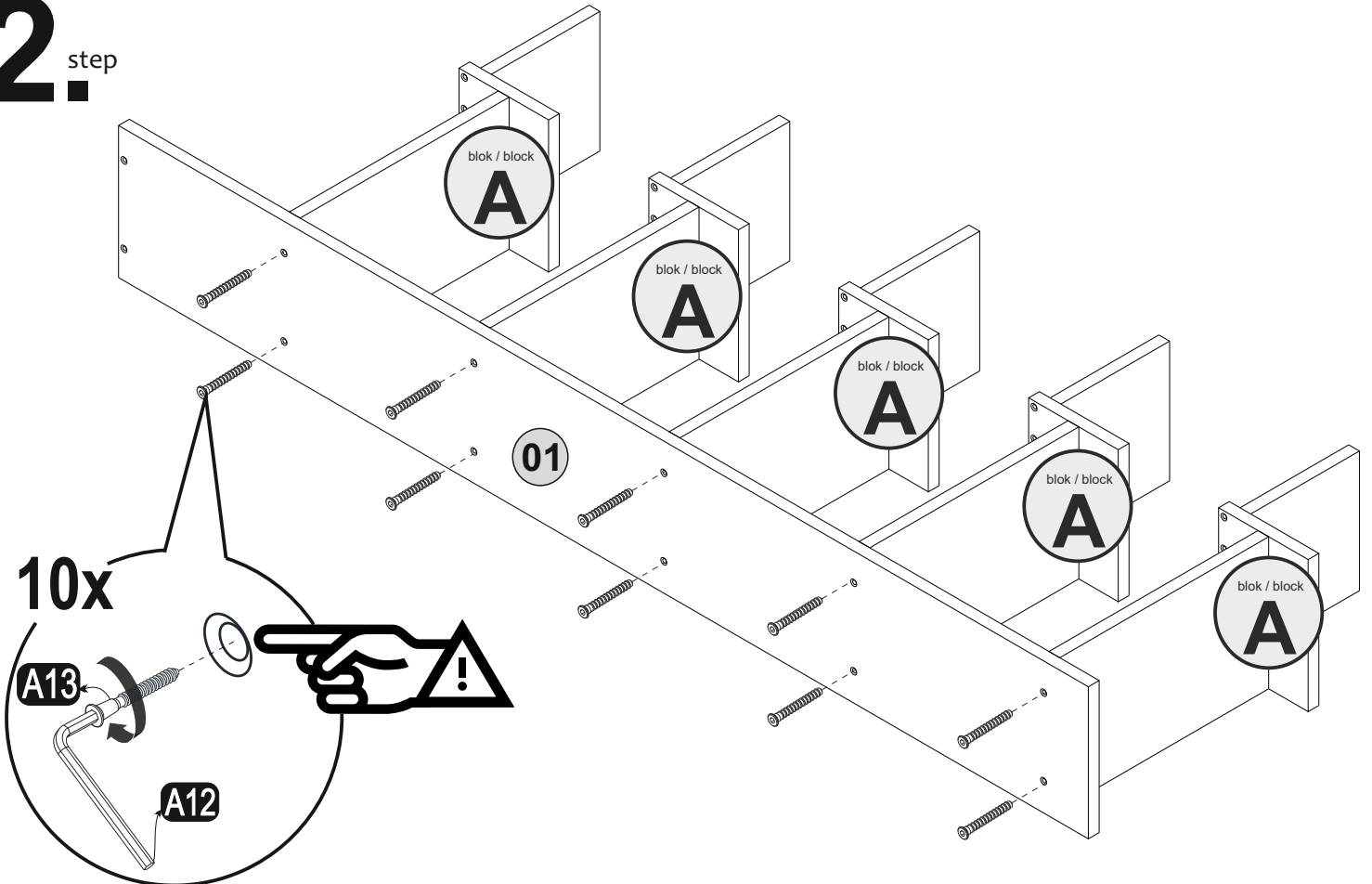

3. step

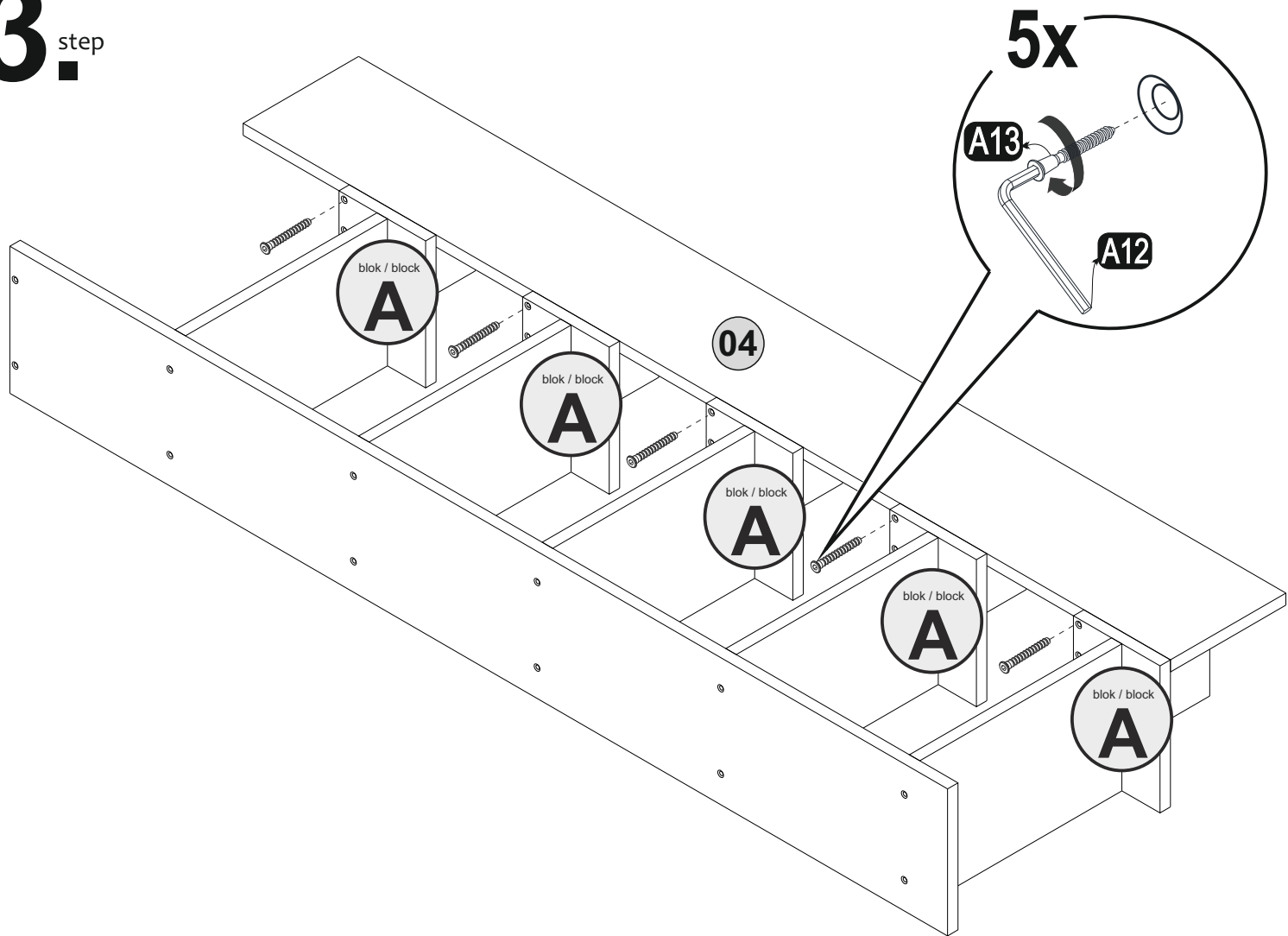

4. step

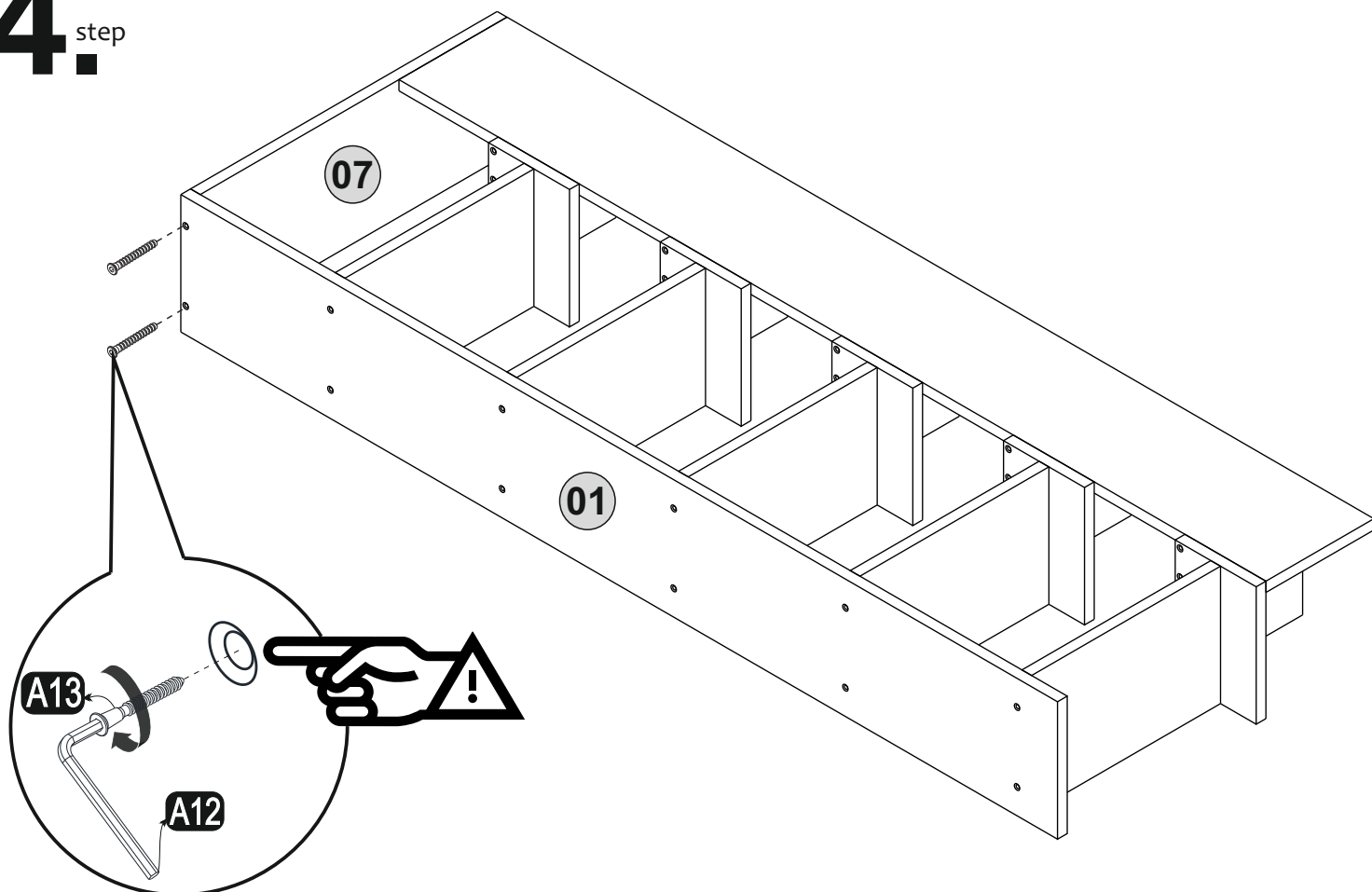

5. step

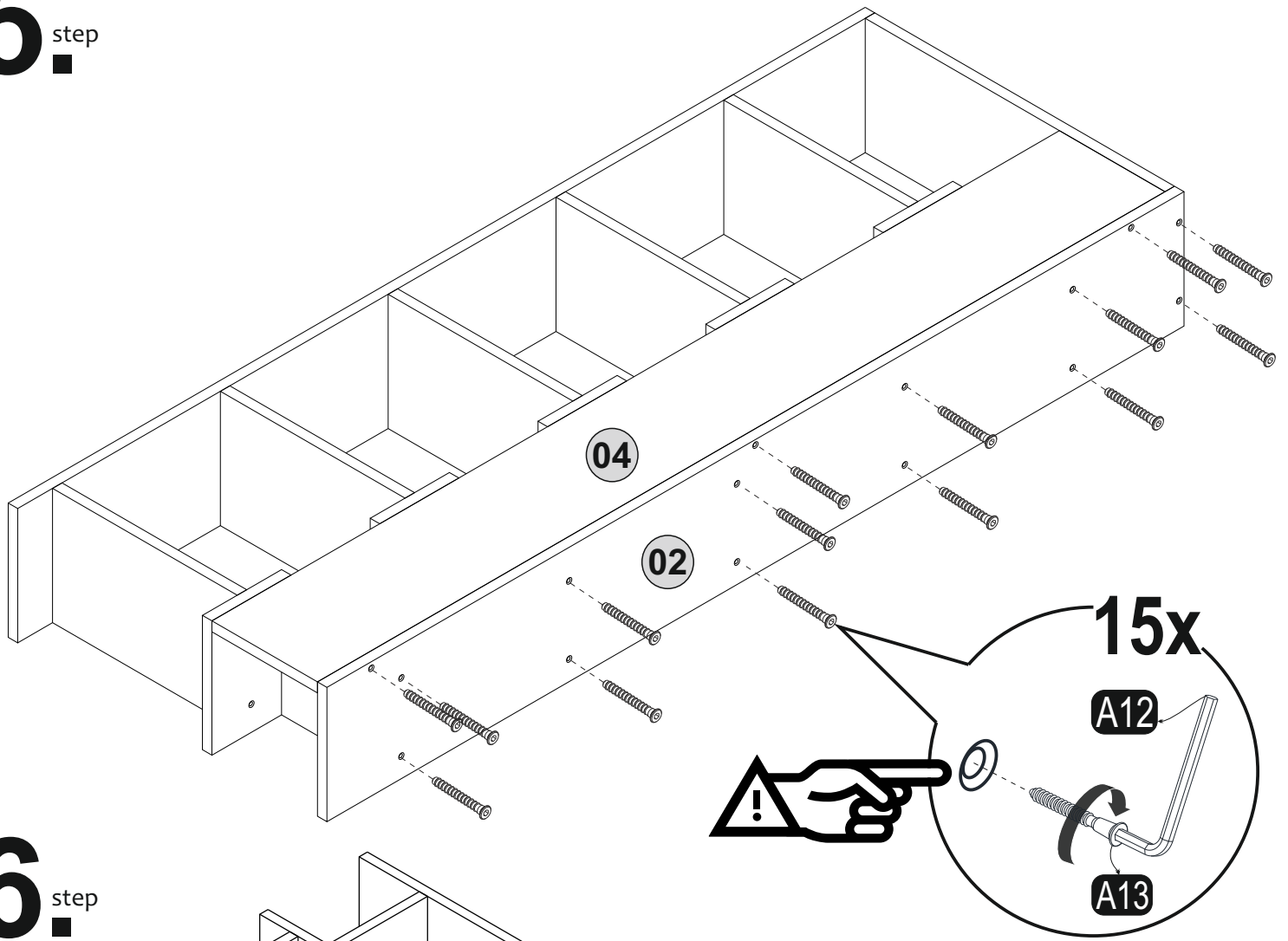

6. step

