

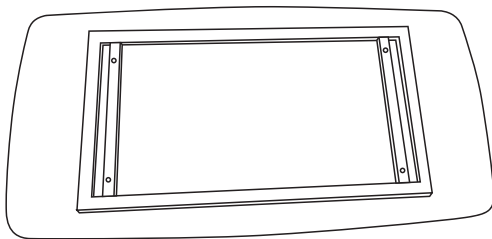

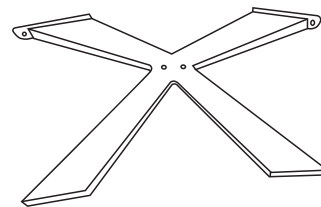





1

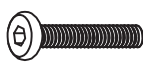

2

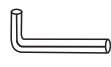

1	1x
2	2x

<p><b>A</b></p>  <p>M8x16mm X4</p>	<p><b>B</b></p>  <p>M6x25mm X2</p>	<p><b>C</b></p>  <p>Ø8xØ22x1.5 X4</p>	<p><b>D</b></p>  <p>M6x18mm X2</p>	<p><b>E</b></p>  <p>5MM X1</p>	<p><b>F</b></p>  <p>4mm X1</p>	<p><b>G</b></p>  <p>X4</p>
---	---	--	---	--	---	---

1

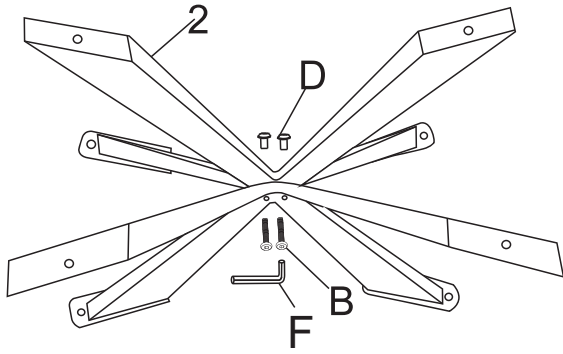

2

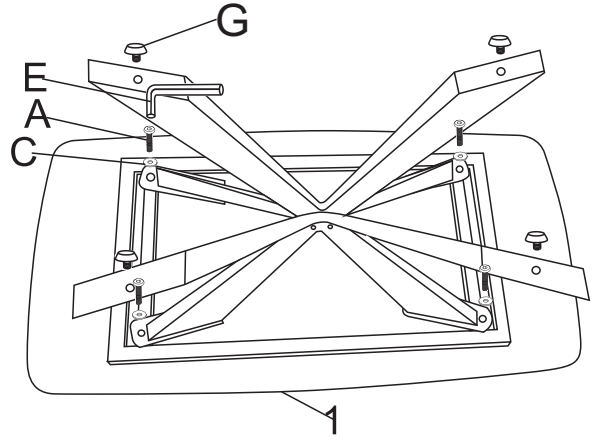

3

