





ASSEMBLY INSTRUCTIONS

MODEL : 097-000008



IMPORTANT NOTE :

- * PLACE ALL WOODEN PARTS ON A CLEAN AND SMOOTH SURFACE SUCH AS A RUG OR CARPET TO AVOID THE PARTS FROM BEING SCRATCHED.
- * BEFORE YOU BEGIN, KINDLY FOLLOW THE ASSEMBLY INSTRUCTIONS STEP BY STEP.
- * DO NOT TIGHTEN ALL SCREWS UNTIL THE CHAIR IS FULLY SET-UP.

HARDWARE LIST		PART LIST	
A	JCBC M6 x 25mm + S/W M6 + F/W M6 x 13mm 	4PCS	1 RIGHT SIDE FRAME 1PC
B	JCBC M6 x 45mm + S/W M6 + F/W M6 x 13mm 	4PCS	2 LEFT SIDE FRAME 1PC
C	ALLEN KEY M4 	1PC	3 FRONT STRETCHER 1PC
D	L BRACKET 	4PCS	4 BACK STRETCHER 1PC
E	PH SCREW M4 x 12mm 	8PCS	5 TOP REST 1PC
F	WOOD DOWEL M8 x 25mm 	2PCS	6 CUSHION SEAT 1PC

CAUTIONS :

(1) DO NOT FULLY-TIGHTEN THE NUT OR NUT BOLTS INITIALLY UNTIL ALL NUTS OR BOLT IS READY ASSEMBLED.

(TO AVOID CAUSING DAMAGES TO THE THREAD, DO NOT OVER-TIGHTEN THE NUTS OR BOLTS.)

(2) KEEP ALL HARDWARE PART OUT OF REACH OF CHILDREN.

STEP 1

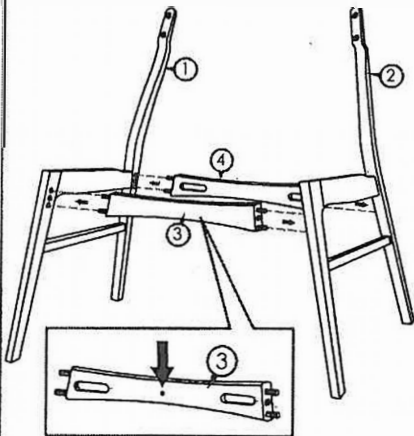

Front Stretcher has a small hole for identification.

STEP 2

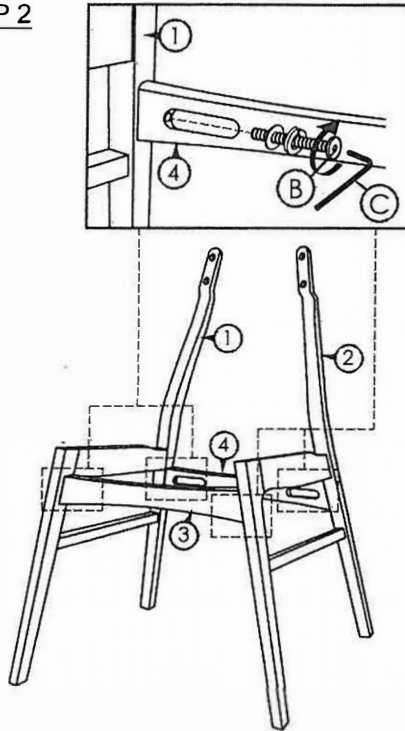

STEP 3

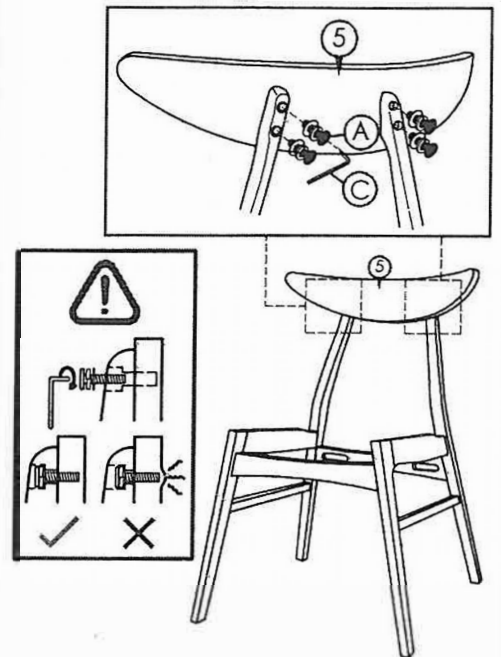

STEP 4

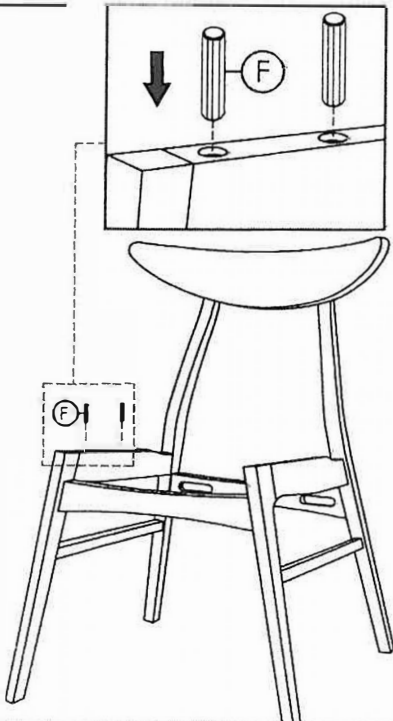

STEP 5

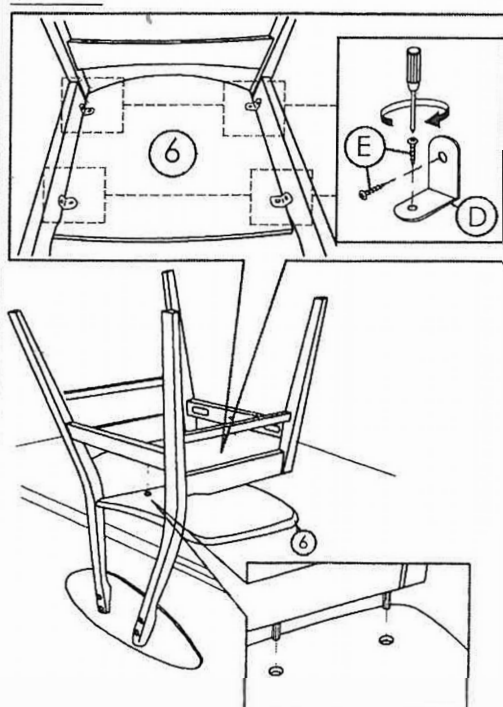

STEP 6



COMPLETED CHAIR ASSEMBLY.