

















# Royal

A	2300x560	1/7
B	2300x560	1/7
C	2188x560	2/7
D	1468x560	3/7
E	1468x560	3/7
F	2x 968x560	4/7
G	484x560	4/7
H	3x 484x484	3,4/7
I	1468x80	3/7
J	540x80	2/7

K	2215x505	2/7
L	2x 2215x493	2/7
M	3x 497x497	5/7
N	1717x497	5/7
O	2x 1311x497	6/7
P	4x 500x140	3,5/7
Q	4x 911x140	7/7
R	2x 940x495	2/7
S	2x 200x997	7/7

30x  10174	2x  10072	43x  φ 8/30 10013	34x  50317	9x  40158	6x  40161	2x  L 500 mm: 50957	2x  50011
12x  50332	6x  50738	8x  20200	4x  φ 4/45 10008	18x  φ 4/30 10006	12x  φ 3,5/20 10002	79x  φ 3,5/16 10001	 10033

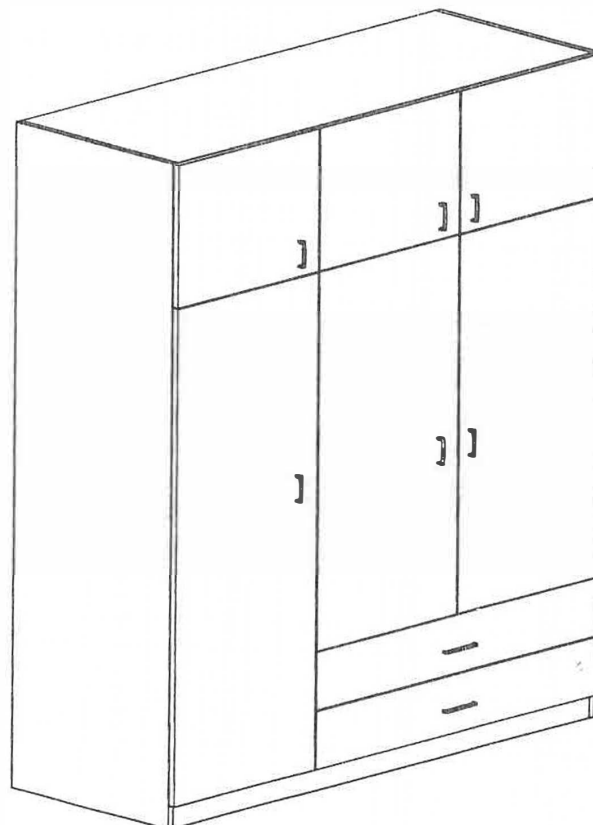

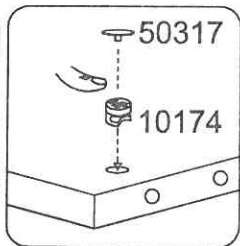
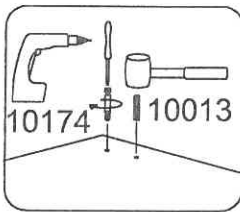
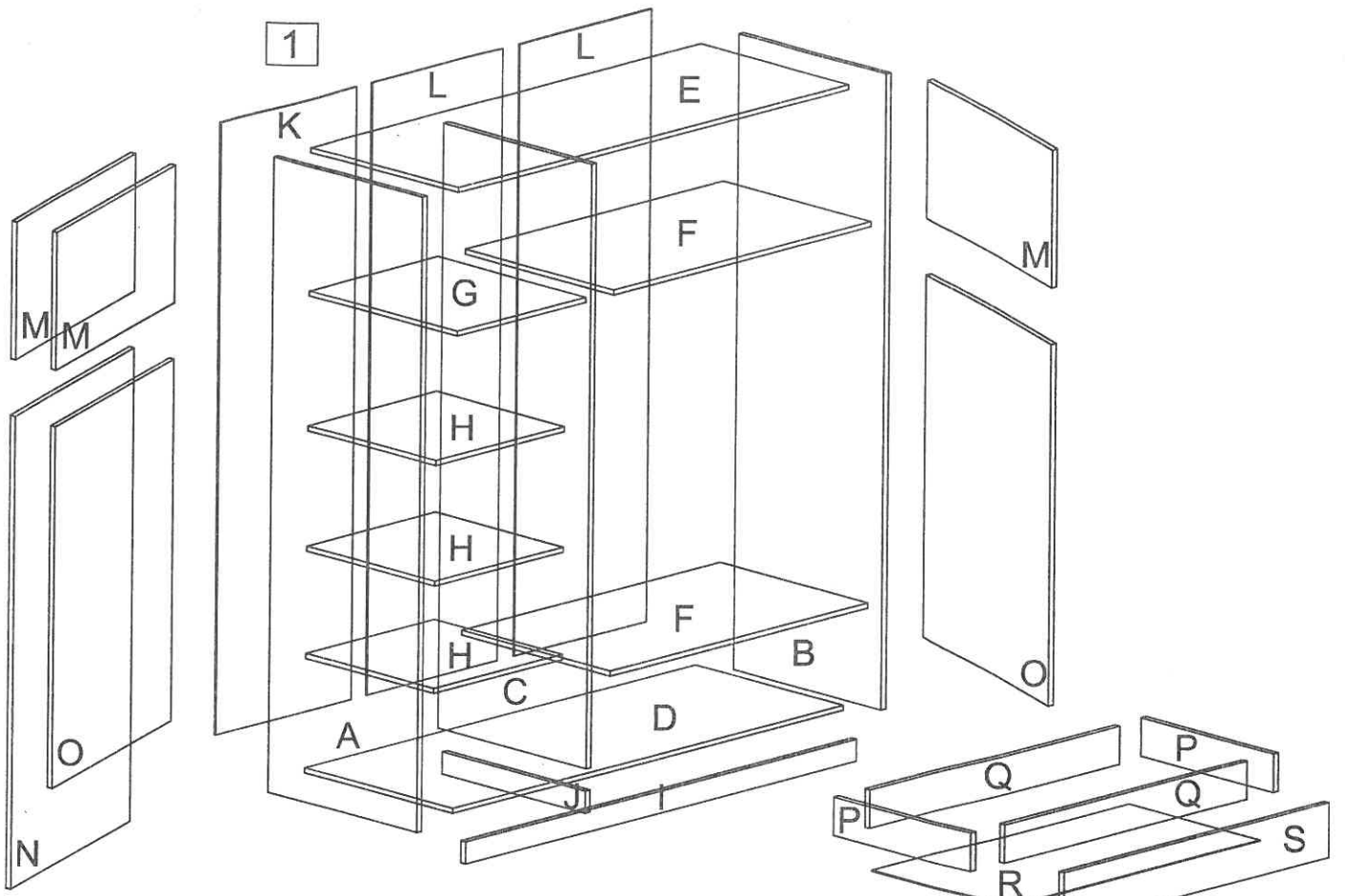

1.1

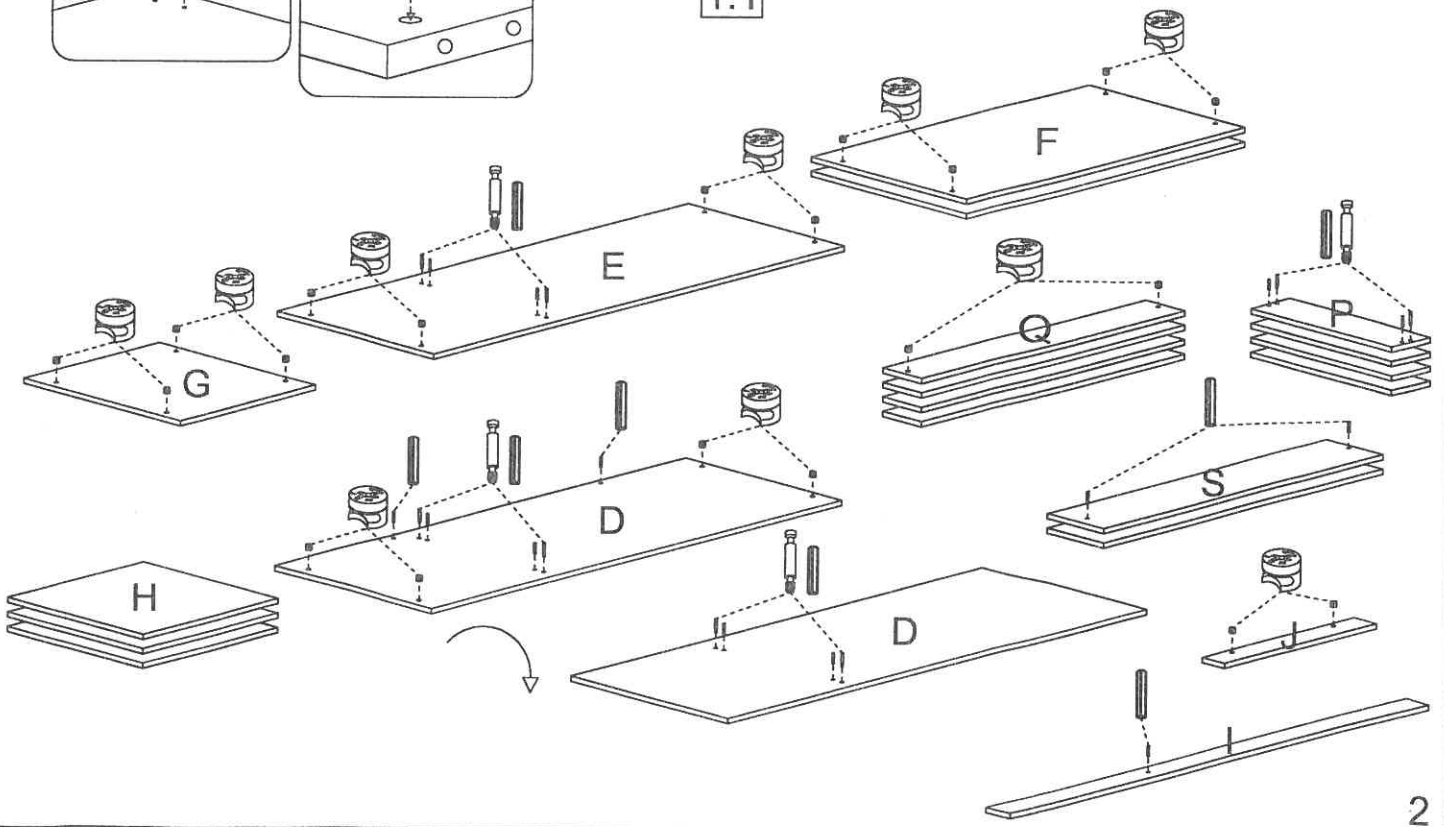

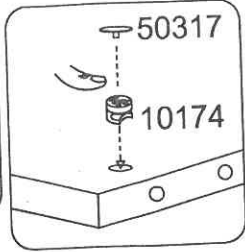
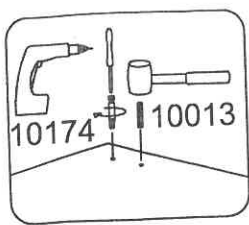

1.1

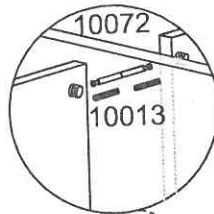
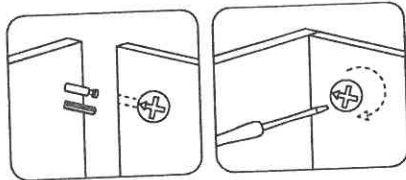
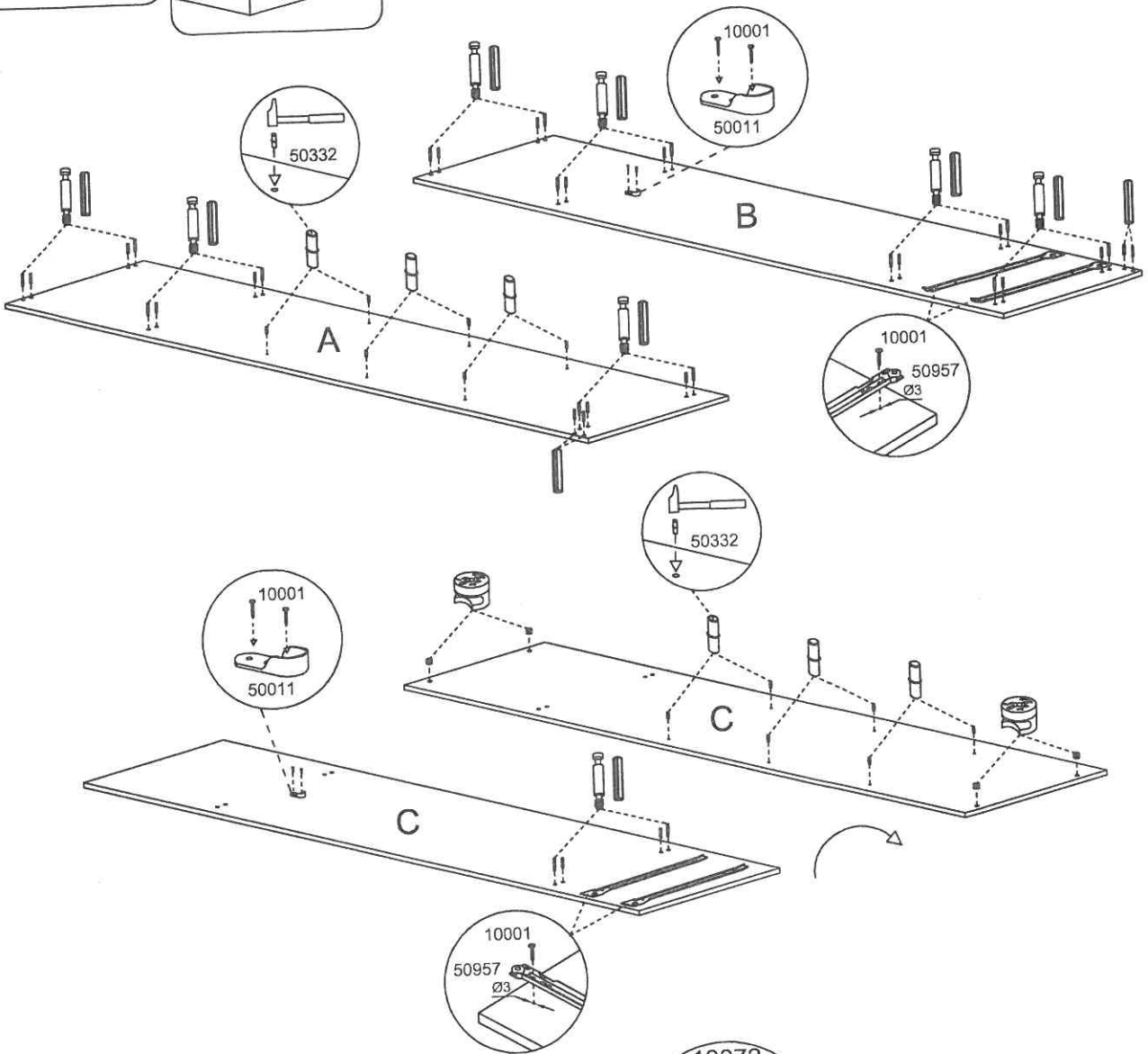

1.2

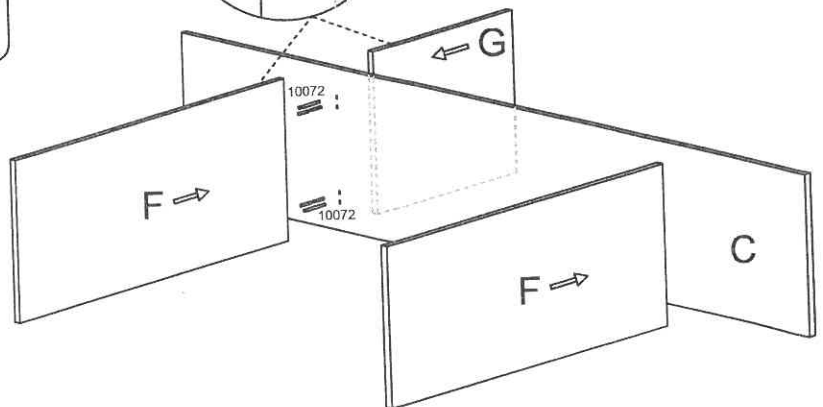

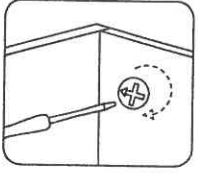
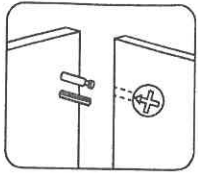

1.3

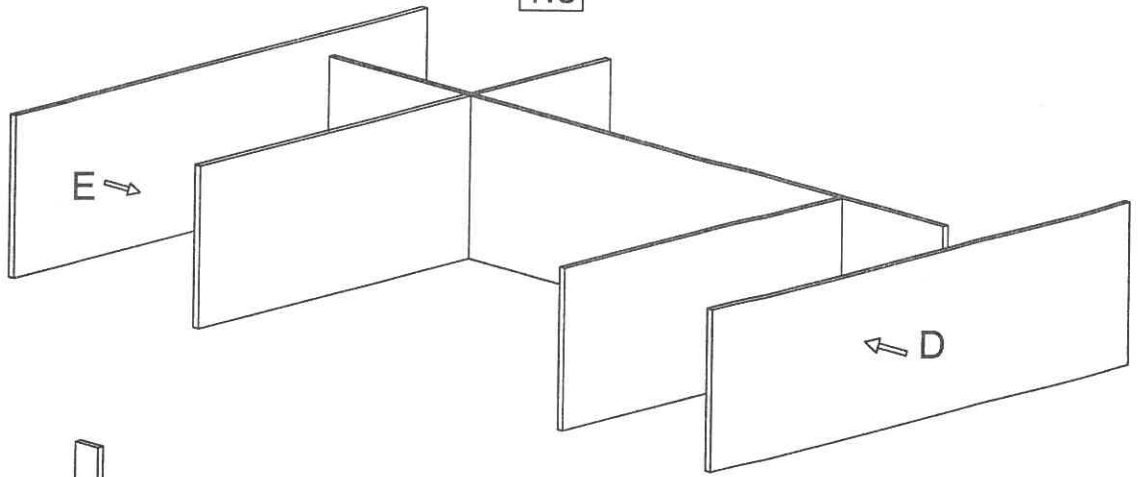

1.4

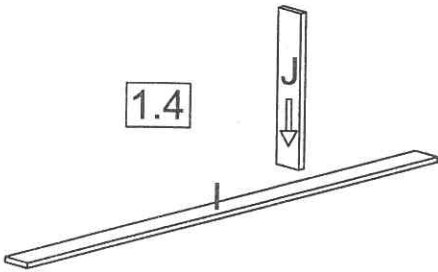

1.5

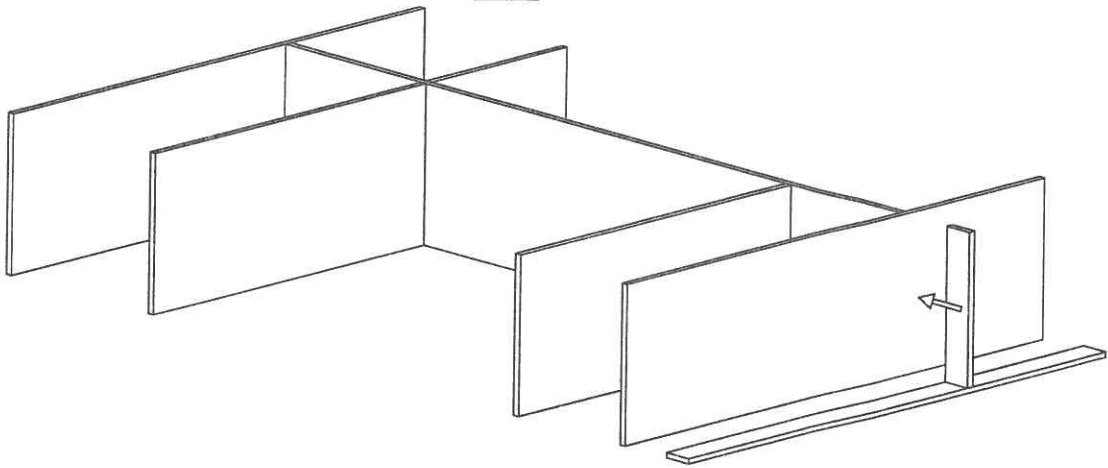

1.6

